

EN



Bobcat®

Operation & Maintenance Manual



S510

Skid-Steer Loader

S/N A3NK11001 & Above
S/N AZN411001 & Above

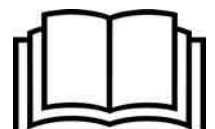

OPERATOR SAFETY WARNINGS

WARNING

Operator must have instructions before operating the machine. Untrained operators can cause injury or death.

W-2001-0502

CORRECT

P-90216

Safety Alert Symbol: This symbol with a warning statement, means: "Warning, be alert! Your safety is involved!" Carefully read the message that follows.

Never use the loader without instructions. See machine signs (decals), Operation & Maintenance Manual, and Operator's Handbook.

CORRECT

NA1254

CORRECT

NA1198

WRONG

NA1201

Always use the seat bar and fasten seat belt snugly.

Always keep feet on the foot pedals or footrests when operating loader.

Never use loader without operator cab with ROPS and FOPS approval. Fasten your seat belt.

Never use loader as man lift or elevating device for personnel.

WRONG

NA1190

WRONG

NA1199

WRONG

NA1194

Do not use loader in atmosphere with explosive dust, explosive gas, or where exhaust can contact flammable material.

Never carry riders.

Keep bystanders away from work area.

Always carry bucket or attachments as low as possible.

Do not travel or turn with lift arms up.

Load, unload, and turn on flat level ground.

WRONG

NA1196

WRONG

NA1197

WRONG

NA1195

Never exceed Rated Operating Capacity.

Never leave loader with engine running or with lift arms up.

To park, engage parking brake and put attachment flat on the ground.

Never modify equipment.

Use only attachments approved by Bobcat Company for this model loader.

SAFETY EQUIPMENT

The Bobcat® loader must be equipped with safety items necessary for each job. Ask your Bobcat dealer for information on the availability and safe use of attachments and accessories.

1. **SEAT BELT:** Check belt fasteners and check for damaged webbing or buckle.
2. **SEAT BAR:** When up, it must lock the loader controls.
3. **OPERATOR CAB (ROPS and FOPS):** It must be on the loader with all fasteners tight.
4. **OPERATOR'S HANDBOOK:** Must be in the cab.
5. **SAFETY SIGNS (DECALS):** Replace if damaged.
6. **SAFETY TREADS:** Replace if damaged.
7. **GRAB HANDLES:** Replace if damaged.
8. **LIFT ARM SUPPORT DEVICE:** Replace if damaged.
9. **PARKING BRAKE**
10. **BOBCAT INTERLOCK CONTROL SYSTEM (BICS)**



CONTENTS

FOREWORD	2
SAFETY AND TRAINING RESOURCES	13
OPERATING INSTRUCTIONS	32
PREVENTIVE MAINTENANCE	118
SYSTEM SETUP AND ANALYSIS	183
SPECIFICATIONS	199
WARRANTY	206
ALPHABETICAL INDEX	208

REFERENCE INFORMATION

Write the correct information for YOUR Bobcat loader in the spaces below. Always use these numbers when referring to your Bobcat loader.

Loader Serial Number _____
Engine Serial Number _____

NOTES:

YOUR BOBCAT DEALER:

ADDRESS:

PHONE:



Bobcat Company
P.O. Box 128
Gwinner, ND 58040-0128
UNITED STATES OF AMERICA

Doosan Bobcat EMEA s.r.o.
U Kodetky 1810
263 12 Dobris
CZECH REPUBLIC



FOREWORD

This Operation & Maintenance Manual was written to give the owner / operator instructions on the safe operation and maintenance of the Bobcat loader. **READ AND UNDERSTAND THIS OPERATION & MAINTENANCE MANUAL BEFORE OPERATING YOUR BOBCAT LOADER.** If you have any questions, see your Bobcat dealer. This manual may illustrate options and accessories not installed on your loader.

DECLARATION OF CONFORMITY	3
BOBCAT COMPANY IS ISO 9001 CERTIFIED	5
REGULAR MAINTENANCE ITEMS	5
Fluids, Lubricants And Fuel	6
SERIAL NUMBER LOCATIONS	7
Loader Serial Number	7
Engine Serial Number	7
DELIVERY REPORT	7
LOADER IDENTIFICATION	8
FEATURES, ACCESSORIES, AND ATTACHMENTS	9
Standard Items	9
Options And Accessories	9
Buckets Available	10
Attachments	10
Special Applications Kit	11
Special Applications Kit Inspection And Maintenance	11
Forestry Door And Window Kit	12
Forestry Door And Window Kit Inspection And Maintenance	12



DECLARATION OF CONFORMITY

Contents of EC Declaration of Conformity

This information is provided in the operators manual to comply with clause 1.7.4.2(c) of Annex I of Machinery Directive 2006/42/EC.

The official EC Declaration of Conformity is supplied in a separate document.

<p>Manufacturer</p>  <p>Bobcat</p> <p>Bobcat Company World Headquarters 250 East Beaton Drive West Fargo, ND 58078-6000 UNITED STATES OF AMERICA</p>	<p>Directive 2000/14/EC: Noise Emission in the Environment by Equipment For Use Outdoors</p> <p>Notified Body Technical and Test Institute for Construction Prague, Czech Republic Notified Body Number: 1020</p>				
<p>Technical Documentation Homologation Manager Doosan Bobcat EMEA s.r.o. U Kodetky 1810 263 12 Dobris CZECH REPUBLIC</p>	<p>EC Certificate No. 1020-090-022395</p> <p>Conformity Assessment Procedure(s) 2000/14/EC, Annex VIII, Full Quality Assurance</p> <p>Sound Power Levels [Lw(A)]</p> <table data-bbox="836 1126 1428 1187"> <tr> <td>Measured Sound Power</td> <td>101 dBA</td> </tr> <tr> <td>Guaranteed Sound Power</td> <td>101 dBA</td> </tr> </table>	Measured Sound Power	101 dBA	Guaranteed Sound Power	101 dBA
Measured Sound Power	101 dBA				
Guaranteed Sound Power	101 dBA				
<p>Description of Equipment Type of Equipment: Wheeled Loader Model Name: S510 Model Code: A3NK Lot Series: 11001</p> <p>Engine Manufacturer: Kubota Engine Model: V2203-M-DI-EU2 Engine Power: 35,9 kW @ 2800 RPM</p>	<p>Equipment conforms to CE Directive(s) Listed Below 2006/42/EC: Machinery Directive 2004/108/EC: Electromagnetic Compatibility Directive</p>				
<p>Declaration of Conformance This equipment conforms to the requirements specified in all the EC Directives listed in this declaration.</p>					
<p>Effective From:</p> <p>11 September 2012</p>					



DECLARATION OF CONFORMITY (CONT'D)

Contents of EC Declaration of Conformity

This information is provided in the operators manual to comply with clause 1.7.4.2(c) of Annex I of Machinery Directive 2006/42/EC.

The official EC Declaration of Conformity is supplied in a separate document.

<p>Manufacturer</p>  <p>Bobcat Company World Headquarters 250 East Beaton Drive West Fargo, ND 58078-6000 UNITED STATES OF AMERICA</p>	<p>Directive 2000/14/EC: Noise Emission in the Environment by Equipment For Use Outdoors</p> <p>Notified Body Technical and Test Institute for Construction Prague, Czech Republic Notified Body Number: 1020</p> <p>EC Certificate No. 1020-090-022395</p> <p>Conformity Assessment Procedure(s) 2000/14/EC, Annex VIII, Full Quality Assurance</p> <p>Sound Power Levels [Lw(A)]</p> <table border="0"> <tr> <td>Measured Sound Power</td> <td style="text-align: right;">101 dBA</td> </tr> <tr> <td>Guaranteed Sound Power</td> <td style="text-align: right;">101 dBA</td> </tr> </table>	Measured Sound Power	101 dBA	Guaranteed Sound Power	101 dBA
Measured Sound Power	101 dBA				
Guaranteed Sound Power	101 dBA				
<p>Technical Documentation Homologation Manager Doosan Bobcat EMEA s.r.o. U Kodetky 1810 263 12 Dobris CZECH REPUBLIC</p>	<p>Equipment conforms to CE Directive(s) Listed Below 2006/42/EC: Machinery Directive 2014/30/EU: Electromagnetic Compatibility Directive</p>				
<p>Description of Equipment Type of Equipment: Wheeled Loader Model Name: S510 Model Code: AZN4 Lot Series: 11001</p> <p>Engine Manufacturer: Kubota Engine Model: V2203-M-DI-EU2 Engine Power: 35,9 kW @ 2800 RPM</p>					
<p>Declaration of Conformance This equipment conforms to the requirements specified in all the EC Directives listed in this declaration.</p>					
<p>Effective From: 20 April 2016</p>					



BOBCAT COMPANY IS ISO 9001 CERTIFIED











ISO 9001 is an international standard that specifies requirements for a quality management system that controls the processes and procedures which we use to design, develop, manufacture, and distribute Bobcat products.

British Standards Institute (**BSI**) is the Certified Registrar Bobcat Company chose to assess the company's compliance with the ISO 9001 at Bobcat's manufacturing facilities in Gwinner, North Dakota (U.S.A.), Pontchâteau (France), and the Bobcat corporate offices (Gwinner, Bismarck, and West Fargo) in North Dakota. **TÜV Rheinland** is the Certified Registrar Bobcat Company chose to assess the company's compliance with the ISO 9001 at Bobcat's manufacturing facility in Dobris (Czech Republic). Only certified assessors, like BSI and TÜV Rheinland, can grant registrations.

ISO 9001 means that as a company we say what we do and do what we say. In other words, we have established procedures and policies, and we provide evidence that the procedures and policies are followed.

REGULAR MAINTENANCE ITEMS

	ENGINE OIL FILTER (6 Pack) 6675517		BATTERY 7306047
	FUEL FILTER 6667352		HYDRAULIC FILTER 7024037
	AIR FILTER, Outer 6666333		HYDRAULIC CHARGE FILTER 6692337 (Earlier Models) 7319444 (Later Models)
	AIR FILTER, Inner 6666334		HYDRAULIC FILL / BREATHER CAP 6727475

NOTE: Always verify Part Numbers with your Bobcat dealer.



REGULAR MAINTENANCE ITEMS (CONT'D)

Fluids, Lubricants And Fuel

The fluids, lubricants and fuel described below are those used in the factory and apply to operating conditions in European temperate climate areas. Please see your Bobcat dealer for requirements in other climate areas.

Read and understand the preventive maintenance required before adding or replacing any fluids or lubricants. (See PREVENTIVE MAINTENANCE on Page 118.)

ENGINE SYSTEMS				
Machine Components	Fluids And Lubricants	T° Range	Packaging**	Part Number
Engine	- Bobcat Engine Power SAE 10W30 CI4 / ACEA E7	-35°C - +30°C	A, B, C, D	6987789
	- Bobcat Engine Power SAE 15W40 CI4 / ACEA E7	-20°C - +40°C	A, B, C, D	6987790
	- Bobcat Engine Power SAE 10W30 CJ4 / ACEA E9	-25°C - +30°C	A, B, C, D	6987818*
	- Bobcat Engine Power SAE 15W40 CJ4 / ACEA E9	-20°C - +40°C	A, B, C, D	6987819
Cooling Circuit	- Bobcat PG Coolant Concentrated	-36°C	B, C, D	6987813*
	- Bobcat PG Coolant 4 Seasons	-36°C	A, B, C, D	6987793
Fuel Tank	- High-quality diesel fuel that meets EN590 (See FUEL SYSTEM on Page 143.)	-	-	*

HYDRAULIC / HYDROSTATIC SYSTEMS				
Machine Components	Fluids And Lubricants	T° Range	Packaging**	Part Number
Hydraulic Fluid Tank	- Bobcat Superior SH Hydraulic / Hydrostatic	-35°C - +50°C	A, B, C, D	6987791*
	- Bobcat Biodegradable Hydraulic / Hydrostatic	-35°C - +50°C	A, B, C, D	6987792

MECHANICAL SYSTEMS				
Machine Components	Fluids And Lubricants	Drop Point	Packaging**	Part Number
All Mechanical Systems	- Bobcat Multipurpose Grease	From 260°C	E	6987888*
	- Bobcat Supreme HD Grease	From 280°C	E	6987889
	- Bobcat Extreme HP Grease	From 260°C	E	6987890

(*) Factory Filled Fluids And Lubricants

(**) Packaging Available:

A = 5 L Can

B = 25 L Container

C = 209 L Drum

D = 1000 L Tank

E = 400 g Tube

SERIAL NUMBER LOCATIONS

Always use the serial number of the loader when requesting service information or when ordering parts. Early or later models (identification made by serial number) may use different parts, or there may be different procedures to follow when performing a specific service operation.

Loader Serial Number

Figure 1

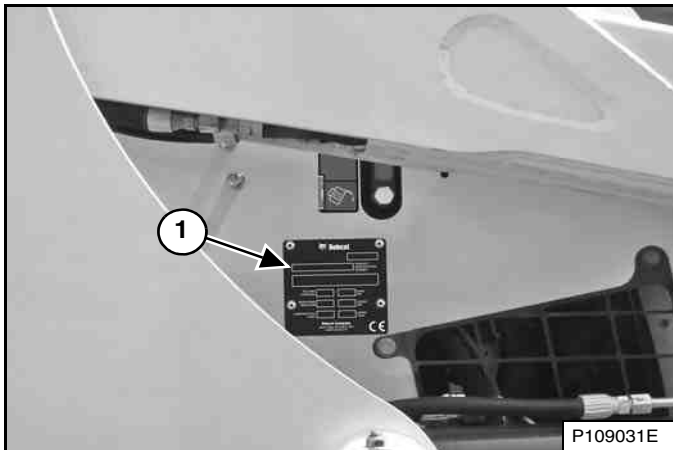

The loader serial number plate (Item 1) [Figure 1] is located on the outside of the loader frame.

Engine Serial Number

Figure 2

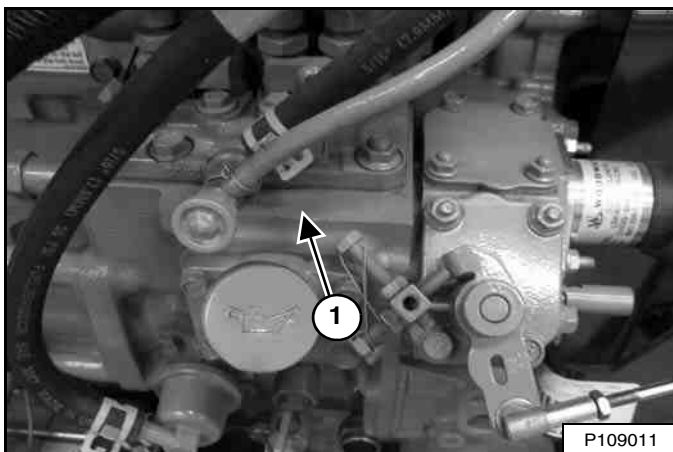

The engine serial number (Item 1) [Figure 2] is located above the oil fill cap.

DELIVERY REPORT

Figure 3

The delivery report [Figure 3] contains a list of items that must be explained or shown to the owner or operator by the dealer when the Bobcat loader is delivered.

The delivery report must be reviewed and signed by the owner or operator and the dealer.

LOADER IDENTIFICATION

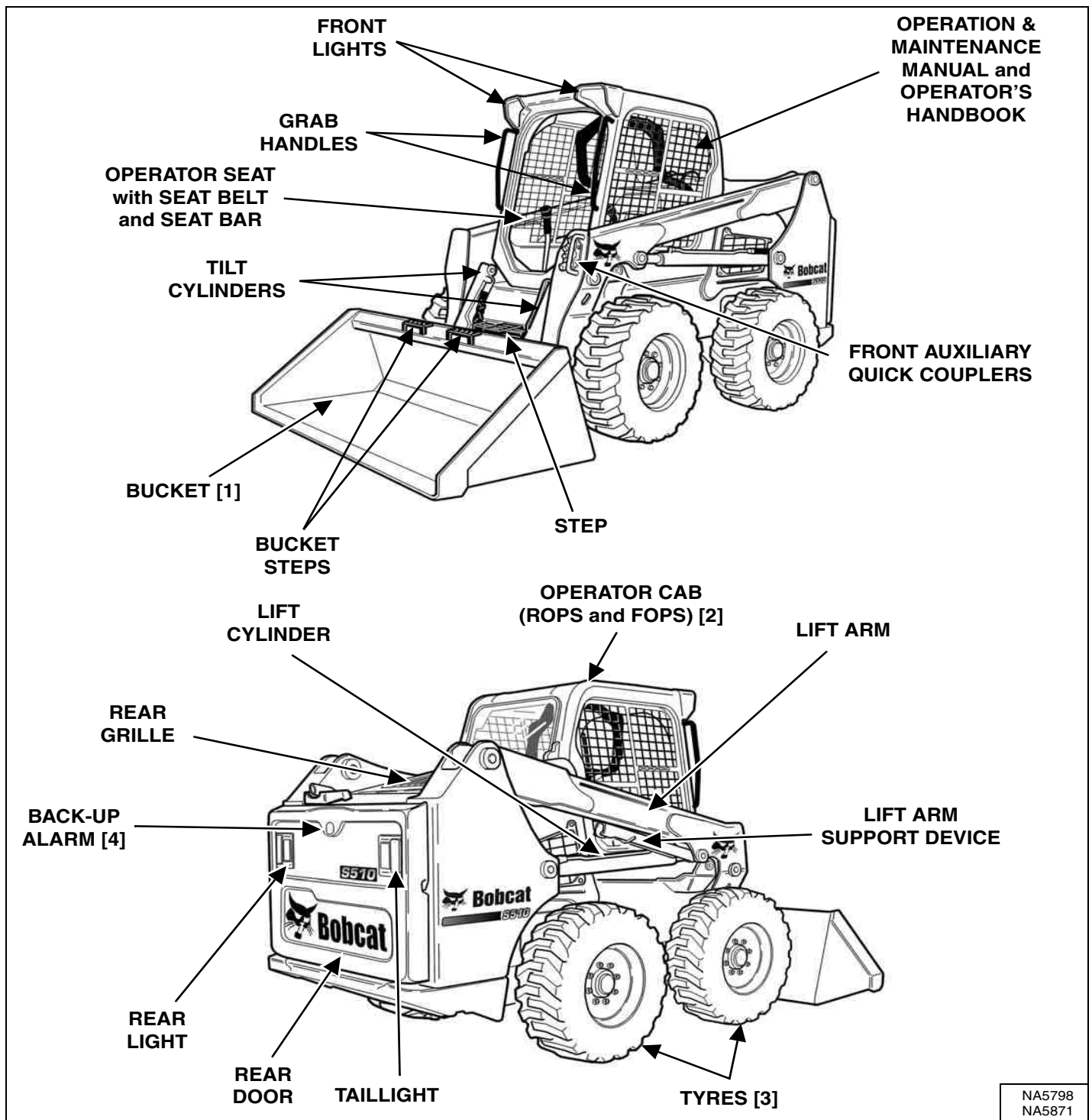

NA5798
NA5871

- [1] BUCKETS - Several different buckets and other attachments are available for the Bobcat loader.
- [2] ROPS - Roll-Over Protective Structure per ISO 3471 and FOPS - Falling-Object Protective Structure per ISO 3449, Level I. Level II is available.
- [3] TYRES - Standard tyres are shown. Several different tyre styles and sizes are available for the Bobcat loader.
- [4] Optional or Field Accessory, (Not Standard Equipment.)



FEATURES, ACCESSORIES, AND ATTACHMENTS

Standard Items

Model S510 Bobcat loaders are equipped with the following standard items:

- Access Covers
- Adjustable Suspension Seat
- Automatically Activated Glow Plugs
- Auxiliary Hydraulics
- Bobcat Interlock Control System (BICS™)
- Bob-Tach®
- Cab (includes: rear and side windows and polycarbonate top window) ROPS and FOPS (Level I) Approved
- Cab Accessory Harness
- CE Certification
- Deluxe Interior with Storage Compartments
- Engine / Hydraulic Systems Shutdown
- Exhaust Shield
- Front Horn
- Hydraulic Bucket Positioning (With On / Off Selection)
- Instrumentation: Hourmeter, Engine rpm, System Voltage; Engine Temperature and Fuel Gauges; Warning Lights
- Lift Arm Support Device
- Lights, Front and Rear
- Parking Brake
- Seat Bar
- Seat Belt
- Sound Reduction Kit (Reduces noise at operator ear)
- Spark Arrester Device
- Tailgate Lock
- Tyres (Bobcat Standard Duty, 10 - 16.5, 8 PR)

Options And Accessories

Below is a list of some equipment available from your Bobcat loader dealer as Dealer and / or Factory Installed Accessories and Factory Installed Options. See your Bobcat dealer for other available options and accessories.

- Adjustable Air Ride Suspension Seat
- Air Deflector Kit
- Air Filter Precleaner
- Attachment Control Device (ACD) (7-Pin, 14-Pin)
- Automatic Ride Control
- Auxiliary Hydraulic Coupler Guard
- Back-up Alarm
- Cab Door with Emergency Exit
- Cab Heater
- Cab Reseal Plug Kit
- Controls:
 - Advanced Control System (ACS)
(Selectable Foot Pedal or Hand Control)
 - Advanced Hand Controls (AHC)
 - Selectable Joystick Controls (SJC)
(Selectable 'ISO' or 'H' Pattern Control)
 - Standard Controls
- Counterweight Kit

Options And Accessories (Cont'd)

- Deluxe Instrumentation Panel
- Dual Steering Damper
- Exhaust Purifying Muffler
- Extended Pedals
- Fire Extinguisher
- Foot Area Duct Kit
- FOPS Kit (Level II)
- FOPS Window Kit
- Forestry Door and Window Kit
- Forestry Door Wiper
- Four-Way Flashers (Also adds Turn Signal function)
- Front and Rear Light Guards
- Fuel Sediment Bowl Kit
- Hose Guide
- Hydraulic Muffler
- Isolated Steering Link Kit
- Keyless Start
- Larger Capacity Battery (For cold weather starting)
- Lift Kit (Four-Point, Single-Point)
- Locking Fuel Cap
- Maintenance Platform
- Muffler Guard
- Power Bob-Tach®
- Radio
- Rear Auxiliary Hydraulics
- Rear Bumper Kit
- Rear Camera Kit
- Rear Window Wiper
- Reversing Fan
- Road Kit
- Road Option
- Rotating Beacon
- Seat Belt with 3-Point Restraint (Standard on Two-Speed Models)
- Seat Belt - 3 in. Wide
- Side Lighting
- Special Applications Kit
- Strobe Light
- Tilt Cylinder Guard Kit
- Two-Speed Travel
- Tyres:
 - Bobcat Heavy Duty, 10 - 16.5, 10 PR
 - Bobcat Heavy Duty Offset, 10 - 16.5, 10 PR
 - Bobcat Heavy Duty Offset Poly Fill, 10 - 16.5, 10 PR
 - Bobcat Heavy Duty Poly Fill, 10 - 16.5, 10 PR
 - Bobcat Severe Duty, 10 - 16.5, 10 PR
 - Bobcat Severe Duty Poly Fill, 10 - 16.5, 10 PR
 - Bobcat Solidflex, 31 x 6 x 10
 - Bobcat Super Float, 31 x 12 - 16.5, 10 PR
- Windows:
 - Polycarbonate Rear Window
 - Polycarbonate Side Windows

Specifications subject to change without notice and standard items may vary.



FEATURES, ACCESSORIES, AND ATTACHMENTS (CONT'D)

These and other attachments are approved for use on this model loader. Do not use unapproved attachments. Attachments not manufactured by Bobcat may not be approved.

The versatile Bobcat loader quickly turns into a multijob machine with a tight-fit attachment hook-up ... from bucket to grapple to pallet fork to backhoe, and a variety of other attachments.

See your Bobcat dealer for information about approved attachments and attachment Operation & Maintenance Manuals.

Increase the versatility of your Bobcat loader with a variety of bucket styles and sizes.

Buckets Available

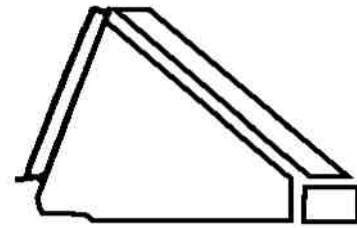

Bucket

Many bucket styles, widths, and different capacities are available for a variety of different applications. They include Construction and Industrial, Low Profile, Fertiliser, and Snow, to name a few. See your Bobcat dealer for the correct bucket for your Bobcat loader and application.

Attachments

- Angle Broom
- Auger
- Backhoe
- Bale Fork
- Bale Handler
- Blades — Box, Dozer, Snow, Snow V-Blade
- Bob-Tach™ Backhoe
- Brush Saw
- Brushcat™ Rotary Cutter
- Bucket Adapter
- Buckets
- Combination Bucket
- Concrete Mixer
- Cutter Crusher
- Digger
- Drop Hammer
- Dumping Hopper
- Flail Cutter
- Forks, Utility
- Grader
- Grapples — Farm / Utility, Industrial, Root
- Hydraulic Breaker
- Landplane
- Landscape Rake
- Mixing Bucket
- Packer Wheel
- Pallet Forks
- Planer
- Salt and Sand Spreader
- Scarifier
- Scraper
- Snowblower
- Snow Pusher
- Sod Layer
- Soil Conditioner
- Stabilisers, Rear
- Stump Grinder
- Sweeper
- Tiller
- Tilt-Tatch™
- Tracks, Steel
- Tree Transplanter
- Trench Compactor
- Trencher
- Utility Frame
- Vibratory Roller
- Water Kit
- Whisker Broom

FEATURES, ACCESSORIES, AND ATTACHMENTS (CONT'D)

Special Applications Kit

Special Applications Kit Inspection And Maintenance



AVOID INJURY OR DEATH

Some attachment applications can cause flying debris or objects to enter front, top or rear cab openings. Install the Special Applications Kit to provide added operator protection in these applications.

- Inspect for cracks or damage. Replace if required.
- Prerinse with water to remove gritty materials.
- Wash with a mild household detergent and warm water.
- Use a sponge or soft cloth. Rinse well with water and dry with a clean soft cloth or rubber squeegee.
- Do not use abrasive or highly alkaline cleaners.
- Do not clean with metal blades or scrapers.

W-2737-0508

Figure 4

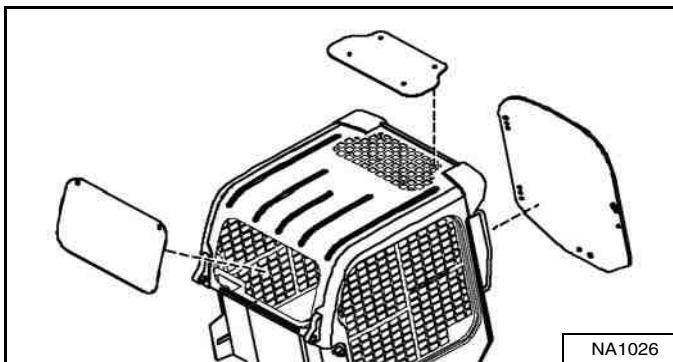

Available for special applications to restrict material from entering cab openings. Kit includes 12,7 mm (0.5 in) thick polycarbonate front door and polycarbonate rear window [Figure 4].

Polycarbonate top window (standard item) must be installed for special applications to restrict material from entering cab openings.

See your Bobcat dealer for availability.

FEATURES, ACCESSORIES, AND ATTACHMENTS (CONT'D)

Forestry Door And Window Kit

Figure 5

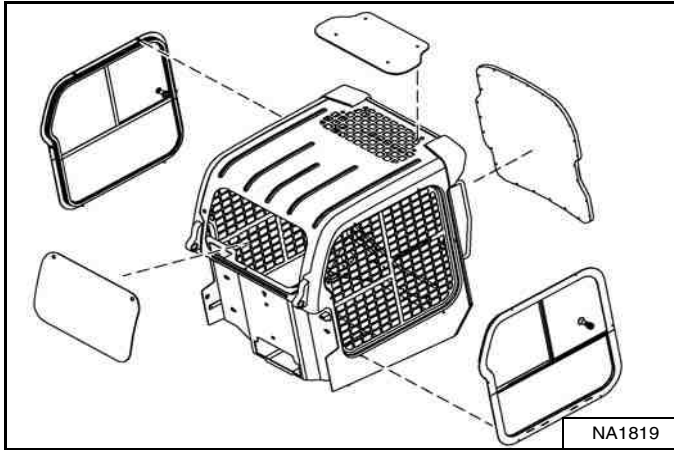

Available for special applications to prevent flying debris and objects from entering the cab. Kit includes 19,1 mm (0.75 in) thick laminated polycarbonate front door, polycarbonate side windows, and polycarbonate rear window **[Figure 5]**.

Polycarbonate top window (standard item) must be installed as part of the Forestry Door And Window Kit to restrict material from entering cab openings.

Forestry Door And Window Kit Inspection And Maintenance

- Inspect for cracks or damage. Replace if required.
- Order part number 7171104 if door frame is damaged and needs to be replaced.
- Order kit part number 7193293 if door polycarbonate is damaged and needs to be replaced.
- Prerinse with water to remove gritty materials.
- Wash with a mild household detergent and warm water.
- Use a sponge or soft cloth. Rinse well with water and dry with a clean soft cloth or rubber squeegee.
- Do not use abrasive or highly alkaline cleaners.
- Do not clean with metal blades or scrapers.

Forestry Door Emergency Exit

Figure 6

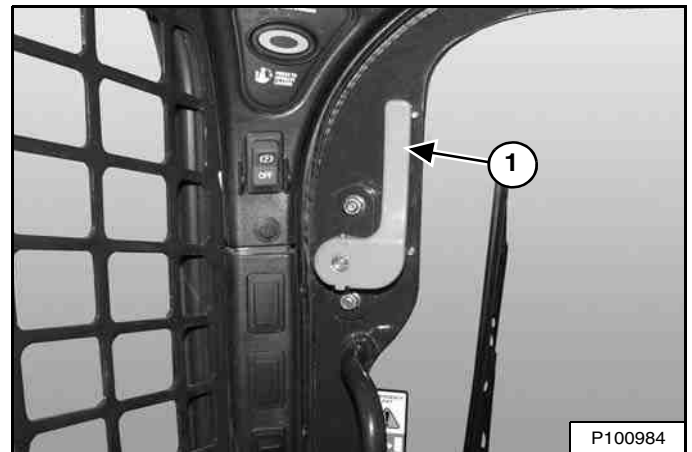

- Inspect both emergency exit levers (Item 1) **[Figure 6]**, linkages, and hardware for loose or damaged parts.
- Repair or replace if necessary.



SAFETY AND TRAINING RESOURCES

SAFETY INSTRUCTIONS 14

 Before Operation 14

 Safe Operation Is The Operator’s Responsibility 15

 Safe Operation Needs A Qualified Operator 15

 Avoid Silica Dust 16

FIRE PREVENTION 16

 Maintenance 16

 Operation 16

 Electrical 16

 Hydraulic System 17

 Fueling 17

 Starting 17

 Spark Arrester Exhaust System 17

 Welding And Grinding 17

 Fire Extinguishers 17

PUBLICATIONS AND TRAINING RESOURCES 18

MACHINE SIGNS (DECALS) 19

 Pictorial Only Safety Signs 21



SAFETY INSTRUCTIONS

Before Operation

Carefully follow the operating and maintenance instructions in this manual.

The Bobcat loader is highly manoeuvrable and compact. It is rugged and useful under a wide variety of conditions. This presents an operator with hazards associated with off motorway, rough terrain applications, common with Bobcat loader usage.

The Bobcat loader has an internal combustion engine with resultant heat and exhaust. All exhaust gases can kill or cause illness so use the Loader with adequate ventilation.

The dealer explains the capabilities and restrictions of the Bobcat loader and attachment for each application. The dealer demonstrates the safe operation according to Bobcat instructional materials, which are also available to operators. The dealer can also identify unsafe modifications or use of unapproved attachments. The attachments and buckets are designed for a Rated Operating Capacity (some have restricted lift heights). They are designed for secure fastening to the Bobcat loader. The user must check with the dealer, or Bobcat literature, to determine safe loads of materials of specified densities for the machine - attachment combination.

The following publications and training materials provide information on the safe use and maintenance of the Bobcat machine and attachments:

- The Delivery Report is used to assure that complete instructions have been given to the new owner and that the machine and attachment is in safe operating condition.
- The Operation & Maintenance Manual delivered with the machine or attachment gives operating information as well as routine maintenance and service procedures. It is a part of the machine and can be stored in a container provided on the machine. Replacement Operation & Maintenance Manuals can be ordered from your Bobcat dealer.
- Machine signs (decals) instruct on the safe operation and care of your Bobcat machine or attachment. The signs and their locations are shown in the Operation & Maintenance Manual. Replacement signs are available from your Bobcat dealer.
- An Operator's Handbook is fastened to the operator cab of the loader. Its brief instructions are convenient to the operator. See your Bobcat dealer for more information on translated versions.

The dealer and owner / operator review the recommended uses of the product when delivered. If the owner / operator will be using the machine for a different application(s) he or she must ask the dealer for recommendations on the new use.



SAFETY INSTRUCTIONS (CONT'D)

Safe Operation Is The Operator's Responsibility



Safety Alert Symbol

This symbol with a warning statement means:
 "Warning, be alert! Your safety is involved!"
 Carefully read the message that follows.



WARNING

Operator must have instructions before operating the machine. Untrained operators can cause injury or death.

W-2001-0502

IMPORTANT

This notice identifies procedures which must be followed to avoid damage to the machine.

I-2019-0284



DANGER

The signal word DANGER on the machine and in the manuals indicates a hazardous situation which, if not avoided, will result in death or serious injury.

D-1002-1107



WARNING

The signal word WARNING on the machine and in the manuals indicates a potentially hazardous situation which, if not avoided, could result in death or serious injury.

W-2044-1107

The Bobcat loader and attachment must be in good operating condition before use.

Check all of the items on the Bobcat Service Schedule Decal under the 8-10 hour column or as shown in the Operation & Maintenance Manual.

Safe Operation Needs A Qualified Operator

For an operator to be qualified, he or she must not use drugs or alcoholic drinks which impair alertness or coordination while working. An operator who is taking prescription drugs must get medical advice to determine if he or she can safely operate a machine.

A Qualified Operator Must Do The Following:

Understand the Written Instructions, Rules and Regulations

- The written instructions from Bobcat Company include the Delivery Report, Operation & Maintenance Manual, Operator's Handbook and machine signs (decals).
- Check the rules and regulations at your location. The rules may include an employer's work safety requirements. For driving on public roads, the machine must be equipped as stipulated by the local regulations authorising operation on public roads in your specific country. Regulations may identify a hazard such as a utility line.

Have Training with Actual Operation

- Operator training must consist of a demonstration and verbal instruction. This training is given by your Bobcat dealer before the product is delivered.
- The new operator must start in an area without bystanders and use all the controls until he or she can operate the machine and attachment safely under all conditions of the work area. Always fasten seat belt before operating.

Know the Work Conditions

- Know the weight of the materials being handled. Avoid exceeding the Rated Operating Capacity (ROC) of the machine. Material which is very dense will be heavier than the same volume of less dense material. Reduce the size of the load if handling dense material.
- The operator must know any prohibited uses or work areas, for example, he or she needs to know about excessive slopes.
- Know the location of any underground lines.
- Wear tight fitting clothing. Always wear safety glasses when doing maintenance or service. Safety glasses, respiratory equipment, hearing protection or Special Applications Kits are required for some work. See your Bobcat dealer about Bobcat Safety Equipment for your model.



SAFETY INSTRUCTIONS (CONT'D)

Avoid Silica Dust



Cutting or drilling concrete containing sand or rock containing quartz may result in exposure to silica dust. Use a respirator, water spray or other means to control dust.

FIRE PREVENTION



Maintenance

The machine and some attachments have components that are at high temperatures under normal operating conditions. The primary source of high temperatures is the engine and exhaust system. The electrical system, if damaged or incorrectly maintained, can be a source of arcs or sparks.

Flammable debris (leaves, straw, etc.) must be removed regularly. If flammable debris is allowed to accumulate, it can cause a fire hazard. Clean often to avoid this accumulation. Flammable debris in the engine compartment is a potential fire hazard.

The operator's area, engine compartment and engine cooling system must be inspected every day and cleaned if necessary to prevent fire hazards and overheating.

All fuels, most lubricants and some coolants mixtures are flammable. Flammable fluids that are leaking or spilled onto hot surfaces or onto electrical components can cause a fire.

Operation

Do not use the machine where exhaust, arcs, sparks or hot components can contact flammable material, explosive dust or gases.

Electrical



Check all electrical wiring and connections for damage. Keep the battery terminals clean and tight. Repair or replace any damaged part or wires that are loose or frayed.

Battery gas can explode and cause serious injury. Use the procedure in the Operation & Maintenance Manual for connecting the battery and for jump starting. Do not jump start or charge a frozen or damaged battery. Keep any open flames or sparks away from batteries. Do not smoke in battery charging area.

FIRE PREVENTION (CONT'D)

Hydraulic System

Check hydraulic tubes, hoses and fittings for damage and leakage. Never use open flame or bare skin to check for leaks. Hydraulic tubes and hoses must be properly routed and have adequate support and secure clamps. Tighten or replace any parts that show leakage.

Always clean fluid spills. Do not use petrol or diesel fuel for cleaning parts. Use commercial non-flammable solvents.

Fueling



Stop the engine and let it cool before adding fuel. No smoking! Do not refuel a machine near open flames or sparks. Fill the fuel tank outdoors.

Ultra Low Sulfur Diesel (ULSD) poses a greater static ignition hazard than earlier diesel formulations with higher Sulfur content. Avoid death or serious injury from fire or explosion. Consult with your fuel or fuel system supplier to ensure the delivery system is in compliance with fueling standards for proper grounding and bonding practices.

Starting

Do not use ether or starting fluids on any engine that has glow plugs or air intake heater. These starting aids can cause explosion and injure you or bystanders.

Use the procedure in the Operation & Maintenance Manual for connecting the battery and for jump starting.

Spark Arrester Exhaust System

The spark arrester exhaust system is designed to control the emission of hot particles from the engine and exhaust system, but the muffler and the exhaust gases are still hot.

Check the spark arrester exhaust system regularly to make sure it is maintained and working properly. Use the procedure in the Operation & Maintenance Manual for cleaning the spark arrester muffler (if equipped).

Welding And Grinding

Always clean the machine and attachment, disconnect the battery, and disconnect the wiring from the Bobcat controllers before welding. Cover rubber hoses, battery and all other flammable parts. Keep a fire extinguisher near the machine when welding.

Have good ventilation when grinding or welding painted parts. Wear dust mask when grinding painted parts. Toxic dust or gas can be produced.

Dust generated from repairing non-metallic parts such as hoods, fenders or covers can be flammable or explosive. Repair such components in a well ventilated area away from open flames or sparks.

Fire Extinguishers

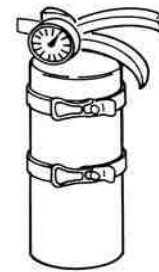

Know where fire extinguishers and first aid kits are located and how to use them. Inspect the fire extinguisher and service the fire extinguisher regularly. Obey the recommendations on the instructions plate.



PUBLICATIONS AND TRAINING RESOURCES

The following publications are also available for your Bobcat loader. You can order them from your Bobcat dealer.

For the latest information on Bobcat products and the Bobcat Company, visit our website at **Bobcat.com**

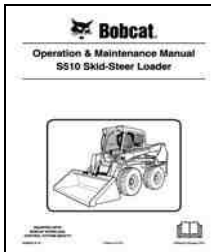

OPERATION & MAINTENANCE MANUAL

6990280enGB

Complete instructions on the correct operation and the routine maintenance of your Bobcat loader.

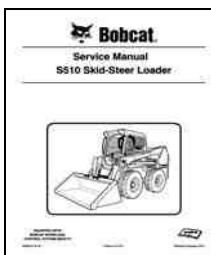

SERVICE MANUAL

6990327enUS

Complete maintenance instructions for your Bobcat loader.

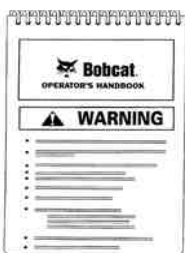

OPERATOR'S HANDBOOK

6987174enGB

Gives basic operation instructions and safety warnings.



MACHINE SIGNS (DECALS)

Follow the instructions on all the Machine Signs (Decals) that are on the loader. Replace any damaged machine signs and be sure they are in the correct locations. Machine signs are available from your Bobcat loader dealer.

- 1 7168038
- 2 Standard, ACS, and AHC 7168141
- 3 3-Point Restraint 7184346
- 4 SJC 7168082
- 5 SJC 7168143
- 6 SJC 7177707
- 7 Standard, ACS, and AHC 7168139
- 8 Back-up Alarm 7180087
- 9 7168037
- 10 7168034
- 11 7168040
- 12 7168033
- 13 Single-Point Lift 7142142 (2)
- 14 Four-Point Lift 7168020

Other decal descriptions include: Standard, ACS, and AHC - 7168137; SJC 7168145; SJC 7168081; SJC 7183746; Door Gas Spring 7170360; Door Gas Spring 7169291; 7223425 (Inside Fuse Access Panel) (Left Foot Area); Door 7168025; Emergency Exit 7177742; Bobcat OPERATOR'S HANDBOOK WARNING 6987174enGB; Standard, ACS, and AHC - 7168273; Rear Window with Latches 7167991.

Inside Cab

- 9 7168037
- 10 7168034
- 11 7168040
- 12 7168033
- 13 Single-Point Lift 7142142 (2)
- 14 Four-Point Lift 7168020

Other sign descriptions include: 7173403 (Behind Bob-Tach); Single-Point Lift 6533898 (2); Single-Point Lift 7168022 (2); Four-Point Lift 7168040; Lift Kit Options; LWA 101dB 6812569.

NA5798



MACHINE SIGNS (DECALS) (CONT'D)

Follow the instructions on all the Machine Signs (Decals) that are on the loader. Replace any damaged machine signs and be sure they are in the correct locations. Machine signs are available from your Bobcat loader dealer.

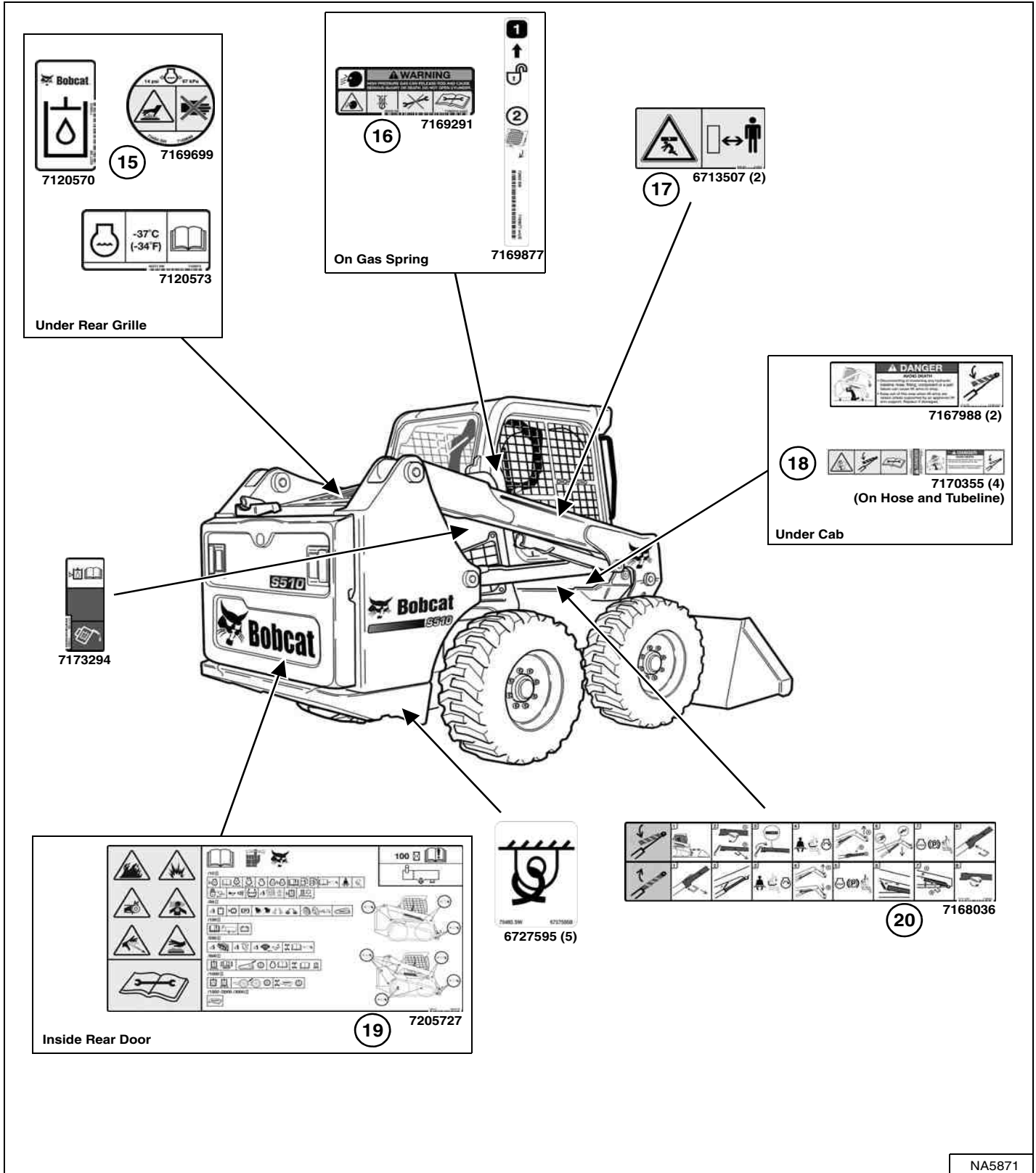

MACHINE SIGNS (DECALS) (CONT'D)

Pictorial Only Safety Signs

Safety signs are used to alert the equipment operator or maintenance person to hazards that may be encountered in the use and maintenance of the equipment. The location and description of the safety signs are detailed in this section. Please become familiarised with all safety signs installed on the machine / attachment.

Vertical Configuration

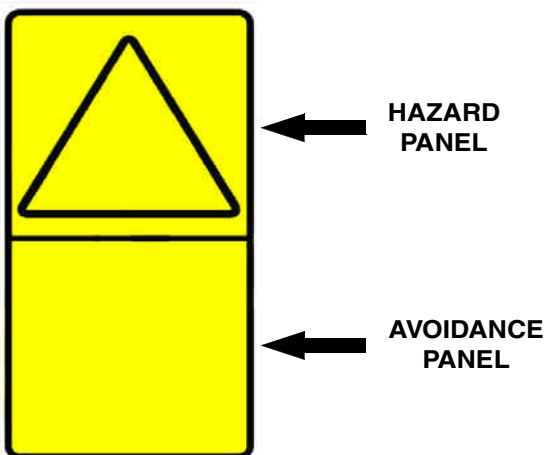

Horizontal Configuration

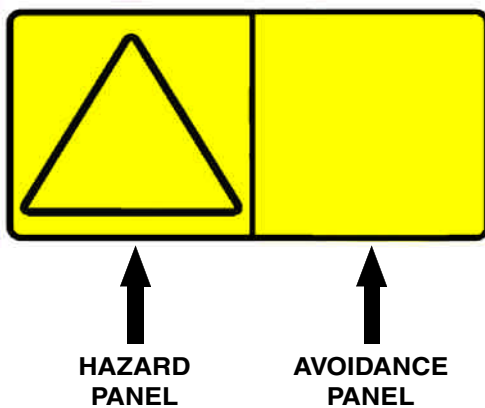

The format consists of the hazard panel(s) and the avoidance panel(s):

Hazard panels depict a potential hazard enclosed in a safety alert triangle.

Avoidance panels depict actions required to avoid the hazards.

A safety sign may contain more than one hazard panel and more than one avoidance panel.

NOTE: See the numbered MACHINE SIGNS (DECALS) on Page 19 and MACHINE SIGNS (DECALS) (CONT'D) on Page 20 for the machine location of each correspondingly numbered pictorial only decal.

1. General Hazard Warning (7168038)

This safety sign is located in the operator cab in the lower right hand corner.



AVOID INJURY OR DEATH

Never use the loader without instructions. Read Operation & Maintenance Manual and Handbook.

Never modify equipment or use attachments not approved by Bobcat Company.

On slopes, keep heavy end of loader uphill.

Do not travel or turn with lift arms up. Load, unload and turn on flat level ground. Do not exceed Rated Operating Capacity (see sign on loader).

W-2837-0310

MACHINE SIGNS (DECALS) (CONT'D)

Pictorial Only Safety Signs (Cont'd)

2. To Leave the Loader (7168141)

This safety sign is located in the operator cab in the lower right hand corner.



AVOID INJURY OR DEATH

TO LEAVE THE LOADER:

1. Lower the lift arms and put attachment flat on the ground.
2. Stop the engine.
3. Engage the brake.
4. Raise seat bar.
5. Move pedals and hand controls until both lock.
6. Exit the loader.

W-2838-0310

3. High Range Speeds (7184346)

This safety sign is located in the operator cab on loaders equipped with a seat belt with 3-point restraint.



**HITTING OBSTRUCTIONS AT HIGH RANGE SPEEDS
CAN CAUSE SERIOUS INJURY OR DEATH**
Fasten shoulder belt for additional restraint when operating at high range speeds.

W-2754-0908

MACHINE SIGNS (DECALS) (CONT'D)

Pictorial Only Safety Signs (Cont'd)

4. SJC Left Hand Joystick (7168082)

This safety sign is located in the operator cab on the left armrest.

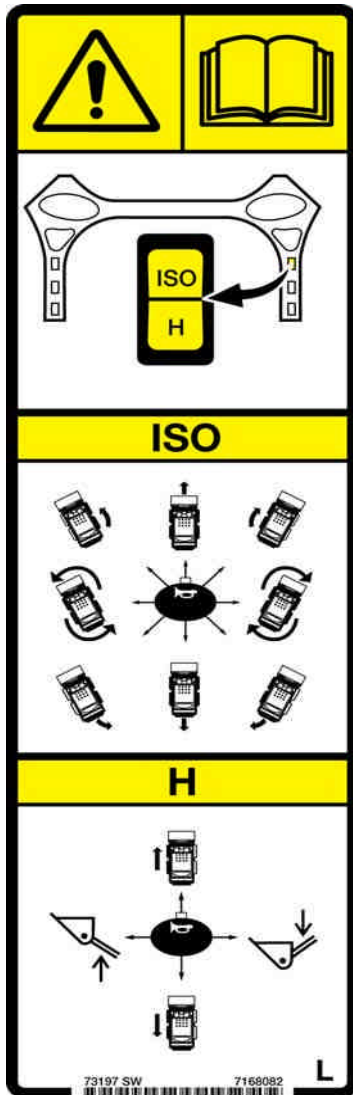

5. To Leave the Loader (7168143)

This safety sign is located in the operator cab in the lower right hand corner.

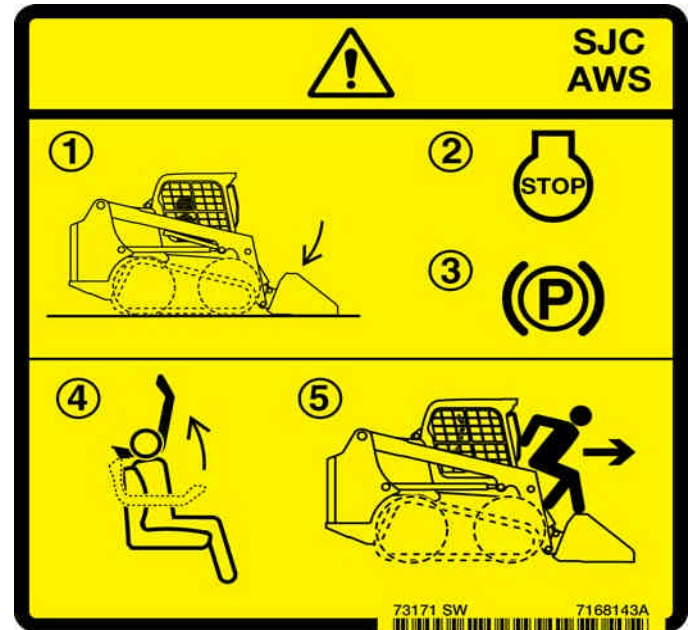

AVOID INJURY OR DEATH

TO LEAVE THE LOADER:

1. Lower the lift arms and put attachment flat on the ground.
2. Stop the engine.
3. Engage the brake.
4. Raise seat bar.
5. Exit the loader.

W-2839-0310



ACCIDENTAL LOADER MOVEMENT CAN CAUSE SERIOUS INJURY OR DEATH

Read and understand the Operation & Maintenance Manual for more information.

- Drive, lift arm and tilt functions operate on different joysticks in each control mode.
- Know and understand the selected control mode before operating.

W-2788-0309

MACHINE SIGNS (DECALS) (CONT'D)

Pictorial Only Safety Signs (Cont'd)

6. SJC Control Pattern Switch (7177707)

This safety sign is located in the operator cab around the SJC control pattern switch on the right panel.

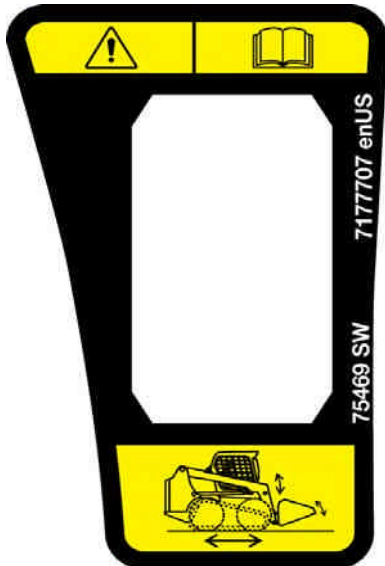

**ACCIDENTAL LOADER MOVEMENT CAN CAUSE
SERIOUS INJURY OR DEATH**

Read and understand the Operation & Maintenance Manual for more information.

- Drive, lift arm and tilt functions operate on different joysticks in each control mode.
- Know and understand the selected control mode before operating.

W-2788-0309

7. Unexpected Loader, Lift Arm or Attachment Movement (7168139)

This safety sign is located in the operator cab on the left side of the seat.

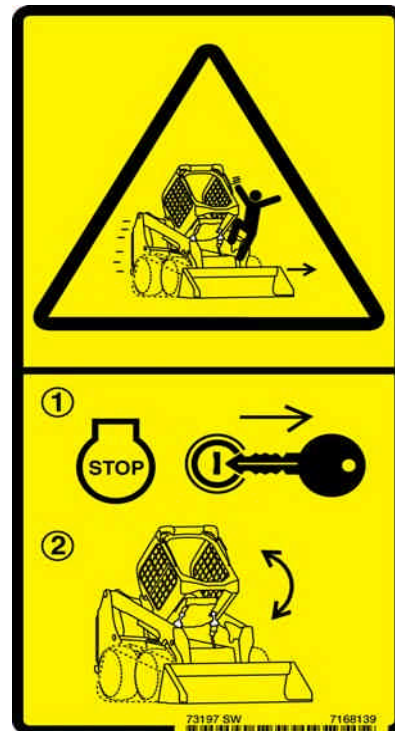

**UNEXPECTED LOADER, LIFT ARM OR ATTACHMENT
MOVEMENT CAUSED BY CAB CONTACT WITH
CONTROLS CAN CAUSE SERIOUS
INJURY OR DEATH**

- **STOP ENGINE** before raising or lowering cab.

W-2758-0908

MACHINE SIGNS (DECALS) (CONT'D)

Pictorial Only Safety Signs (Cont'd)

8. Back-Up Alarm (7180087)

This safety sign is located in the operator cab on the lower left side.



AVOID INJURY OR DEATH

- Always keep bystanders away from the work area and travel path.
- The operator must maintain a clear view of the direction of travel and look before and during machine movement.
- The back-up alarm must sound when operating the machine in the reverse direction.

W-2783-0118

9. Tipping, Rollover or Loss of Visibility (7168037)

This safety sign is located on the back side of the lift arms facing the operator.



TIPPING, ROLLOVER OR LOSS OF VISIBILITY CAN CAUSE SERIOUS INJURY OR DEATH
Carry load low.

W-2836-0310

10. Frame Raising (7168034)

This safety sign is located on the front of the loader.



AVOID DEATH

Attachment can be forced against the ground and cause front frame to raise.

Never go under or reach under lift arms or lift cylinder without an approved lift arm support device installed.

D-1021-0310

MACHINE SIGNS (DECALS) (CONT'D)

Pictorial Only Safety Signs (Cont'd)

11. Falling Hazard (7168040)

This safety sign is located on the front of the loader.



AVOID INJURY OR DEATH

- Never carry riders.
- Never use loader as a man lift or work platform.

W-2835-0310

12. Lift Arm Crushing (7168033)

This safety sign is located on the front of the loader.



AVOID DEATH

Keep out of this area when lift arms are raised unless supported by an approved lift arm support device.

Moving lift arm control or failure of a part can cause lift arms to drop.

D-1020-0310

MACHINE SIGNS (DECALS) (CONT'D)

Pictorial Only Safety Signs (Cont'd)

13. Single-Point Lift (7142142)

This safety sign is located on the side arm of the single-point lift.



FAILURE OF THE LIFT ASSEMBLY CAN CAUSE
SERIOUS INJURY OR DEATH

BEFORE LIFTING LOADER:

1. Check the hardware and fasteners of the Single Point Lift and Operator Cab (ROPS) for proper torque.
 2. Inspect Single Point Lift for damage or cracked welds. Repair or replace components as necessary.
- No riders on loader during lifting. Keep 5 m (15 ft) away while lifting.
 - See Operation & Maintenance Manual for more information.

W-2841-0910

14. Four-Point Lift (7168020)

This safety sign is located on the front of the loader.

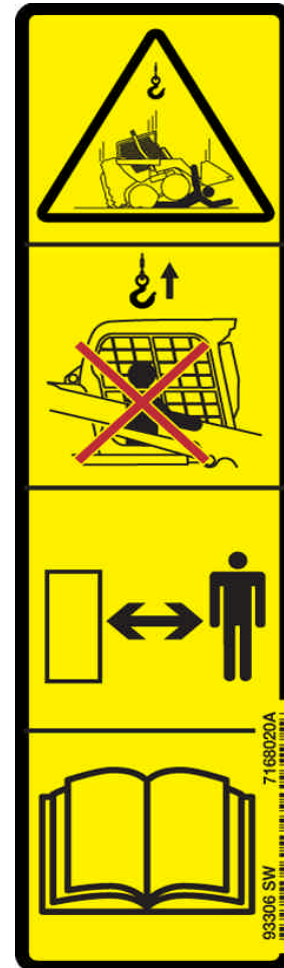

FAILURE OF THE LIFT ASSEMBLY CAN CAUSE
SERIOUS INJURY OR DEATH

BEFORE LIFTING LOADER:

1. Check the hardware and fasteners at all lift points for proper torque.
 2. Inspect lift points for damage or cracked welds. Repair or replace components as necessary.
- No riders on loader and keep 5 m (15 ft) away while lifting.
 - See Operation & Maintenance Manual for more information.

W-2840-0910

MACHINE SIGNS (DECALS) (CONT'D)

Pictorial Only Safety Signs (Cont'd)

15. Hot Pressurised Fluid (7169699)

This safety sign is located on the engine coolant tank cap.



**HOT PRESSURISED FLUID CAN CAUSE
SERIOUS BURNS**

- Never open hot.
- OPEN SLOWLY.

W-2755-EN-0909

16. High Pressure Gas (7169291)

This safety sign is located on the gas spring component(s) supporting the cab and on the front door option.



**HIGH PRESSURE GAS CAN RELEASE ROD AND
CAUSE SERIOUS INJURY OR DEATH**

- Do not open cylinder.
- See Service Manual for more information.

W-2756-0908

MACHINE SIGNS (DECALS) (CONT'D)

Pictorial Only Safety Signs (Cont'd)

17. Crush Hazard (6713507)

This safety sign is located on the side of each lift arm.



Keep away from the operating machine to avoid serious injury or death.

W-2520-0106

18. Lift Arm Crushing (7170355)

This safety sign is located on certain hoses or tubelines inside the loader frame underneath the operator cab.



AVOID DEATH

- Disconnecting hydraulic lines can cause the lift arms or attachment to drop.
- Always use an approved lift arm support when lift arms are in a raised position.

D-1008-0409

MACHINE SIGNS (DECALS) (CONT'D)

Pictorial Only Safety Signs (Cont'd)

19. Service Checklist And Schedule (7205727)

This safety sign is located inside the rear door (tailgate).

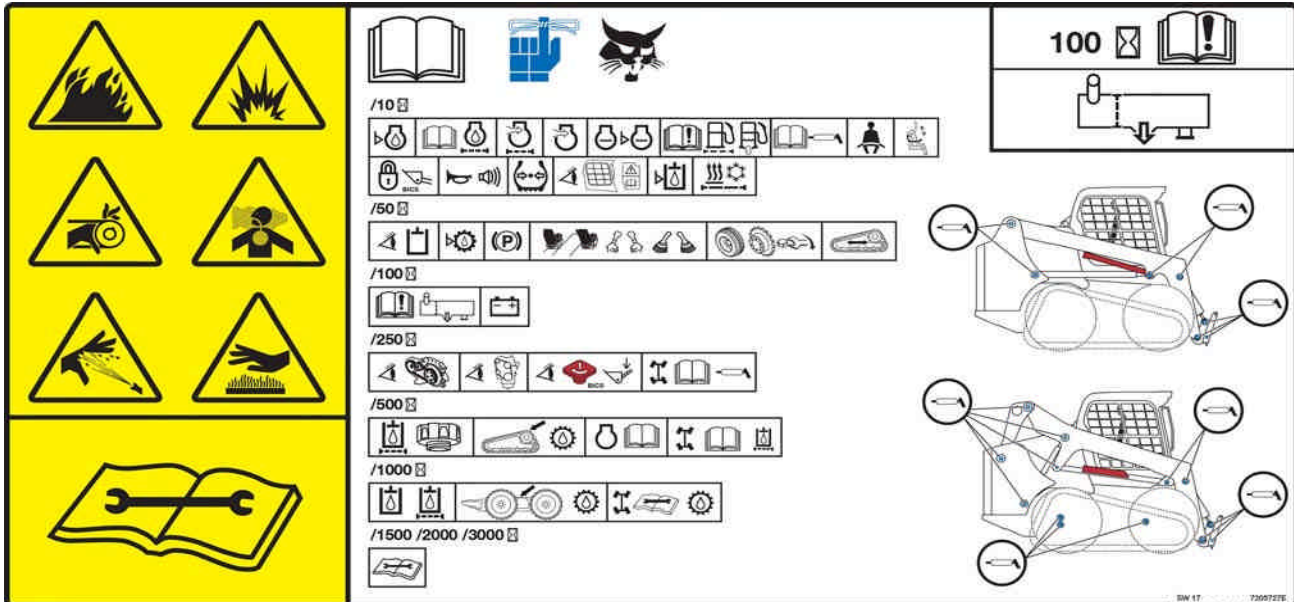

! WARNING

AVOID INJURY OR DEATH

- Keep door / cover closed except for service.
- Keep engine clean of flammable material.
- Keep body, loose objects and clothing away from electrical contacts, moving parts, hot parts and exhaust.
- Do not use the machine in space with explosive dusts or gases or with flammable material near exhaust.
- Never use ether or starting fluid on diesel engine with glow plugs or air intake heater. Use only starting aids as approved by engine manufacturer.
- Leaking fluids under pressure can enter skin and cause serious injury.
- Battery acid causes severe burns; wear goggles. If acid contacts eyes, skin, or clothing, flush with water. For contact with eyes, flush and get medical attention.
- Battery makes flammable and explosive gas. Keep arcs, sparks, flames and lighted tobacco away.
- For jump start, connect negative cable to the machine engine last (never at the battery). After jump start, remove negative connection at the engine first.
- Exhaust gases can kill. Always ventilate.

W-2782-0409

IMPORTANT

This machine is factory equipped with a spark arrester exhaust system that must be maintained for proper function.

- **WITH MUFFLER**
The muffler chamber must be emptied every 100 hours of operation to keep it in working condition.
- **WITH SELECTIVE CATALYST REDUCTION (SCR) AND / OR DIESEL OXIDATION CATALYST (DOC)**
Do not remove or modify the DOC or SCR.

The SCR must be maintained according to the instructions in the Operation & Maintenance Manual for proper function.

- **WITH DIESEL PARTICULATE FILTER (DPF)**
The DPF must be maintained according to the instructions in the Operation & Maintenance Manual for proper function.

(If this machine is operated on flammable forest, brush or grass cover land, a spark arrester attached to the exhaust system may be required and must be maintained in working order. Refer to local laws and regulations for spark arrester requirements.)

I-2350-EN-1114

MACHINE SIGNS (DECALS) (CONT'D)

Pictorial Only Safety Signs (Cont'd)

20. Lift Arm Support Device (7168036)

This safety sign is located on the outside of the operator cab on the lower right side.

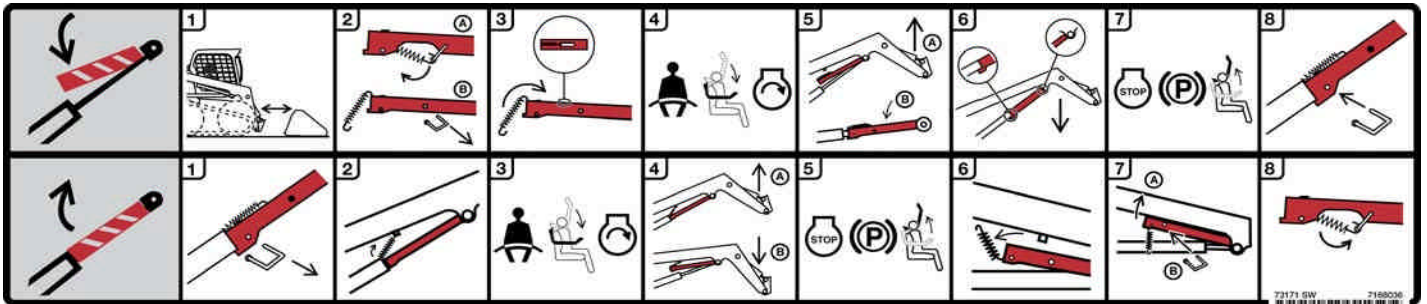

To Engage Lift Arm Support Device:

1. Remove attachment from loader.
2. Unhook spring from pin. Hold lift arm support device. Remove pin. Lower the lift arm support device to the top of the cylinder.
3. Hook spring into slot on top of lift arm support device.
4. Enter loader, fasten seat belt, lower seat bar, and start engine.
5. Raise lift arms until lift arm support device drops on cylinder rod.
6. Lower lift arms slowly until movement stops.
7. Stop engine. Raise seat bar. Move pedals until both pedals lock. Leave loader.
8. Install pin into rear of lift arm support device below cylinder rod.

To Disengage Lift Arm Support Device:

1. Remove pin.
2. Hook spring into bracket below lift arm.
3. Enter loader, fasten seat belt, lower seat bar, and start engine.
4. Raise lift arms until lift arm support device raises off cylinder rod. Lower lift arms.
5. Stop engine. Raise seat bar. Move pedals until both pedals lock. Leave loader.
6. Unhook spring from bracket.
7. Raise lift arm support device to storage position. Insert pin through lift arm support device and bracket.
8. Hook spring to pin.

NOTE: More illustrated and detailed information regarding Installing and Removing the lift arm support device is located in this manual. (See LIFT ARM SUPPORT DEVICE on Page 129.)



OPERATING INSTRUCTIONS

INTENDED USE	36
INSTRUMENT PANEL IDENTIFICATION	37
Overview	37
Left Panel	38
Display Screen	40
Right Panel (Standard Key Panel)	41
Right Panel (Keyless Start Panel)	42
Right Panel (Deluxe Instrumentation Panel)	43
Left Switch Panel	45
Right Switch Panel	45
Left Side Lower Panel	46
Right Side Lower Panel	46
Radio	47
Rear View Camera System	49
CONTROL IDENTIFICATION	51
Description	51
Standard Controls	51
Advanced Control System (ACS)	52
Advanced Hand Controls (AHC)	53
Selectable Joystick Controls (SJC)	54
OPERATOR CAB	55
Description	55
Side Windows	55
Door Operation	55
Front Wiper	56
Cab Light	56
BOBCAT INTERLOCK CONTROL SYSTEM (BICS™)	57
Description	57
Operation	57
SEAT BAR RESTRAINT SYSTEM	58
Description	58
Operation	58
PARKING BRAKE	59
Operation	59
TRACTION LOCK OVERRIDE	59
Description	59
Operation	59
ENGINE SPEED CONTROL	60
Operation	60
LIFT ARM BYPASS CONTROL	60
Description	60
Operation	60



EMERGENCY EXIT	61
Rear Window Identification	61
Rear Window Removal (Latches)	61
Rear Window Removal (Rubber Cord)	61
External Access (Rear Window With Latches)	62
External Access (Rear Window With Rubber Cord)	62
Front Door	62
BACK-UP ALARM SYSTEM	64
Description	64
Operation	64
DRIVING AND STEERING THE LOADER	65
Available Control Configurations	65
Operation (Standard, ACS, And AHC)	65
Operation (SJC) In 'ISO' Control Pattern	66
Operation (SJC) In 'H' Control Pattern	67
STOPPING THE LOADER	68
Using The Control Levers Or Joysticks	68
TWO-SPEED CONTROL	68
Description	68
Operation (Standard, ACS, And AHC)	69
Operation (SJC)	69
SPEED MANAGEMENT	70
Description	70
Operation	70
Changing The Factory Default Setting	71
DRIVE RESPONSE	72
Description	72
Operation	72
STEERING DRIFT COMPENSATION	74
Description	74
Operation	74
LIFT AND TILT COMPENSATION	76
Description	76
Operation	76
Operation (ACS And AHC)	77
Operation (SJC)	78



HYDRAULIC CONTROLS	79
Description	79
Standard Controls And Advanced Control System (ACS) In FOOT Pedal Mode	79
Advanced Control System (ACS) In HAND Control Mode And Advanced Hand Controls (AHC)	80
Selectable Joystick Controls (SJC) In 'ISO' Control Pattern	80
Selectable Joystick Controls (SJC) In 'H' Control Pattern	81
Hydraulic Bucket Positioning	81
Automatic Ride Control	82
Reversing Fan	83
FRONT Auxiliary Hydraulics Operation	84
FRONT Auxiliary Hydraulics Operation (CONTINUOUS FLOW)	85
FRONT Auxiliary Hydraulics Operation (REVERSE CONTINUOUS FLOW)	85
REAR Auxiliary Hydraulics Operation	86
Quick Couplers	87
Quick Coupler Troubleshooting	87
Relieve Auxiliary Hydraulic Pressure (Loader And Attachment)	88
ATTACHMENT CONTROL DEVICE (ACD)	89
Description	89
DAILY INSPECTION	90
Daily Inspection And Maintenance	90
PRE-STARTING PROCEDURE	92
Entering The Loader	92
Operation & Maintenance Manual And Operator's Handbook Locations	92
Seat Adjustment	93
Seat Belt Adjustment	94
Seat Bar	95
Joystick Position Adjustment	95
STARTING THE ENGINE	96
Standard Key Panel	96
Keyless Start Panel	98
Deluxe Instrumentation Panel	100
Warming The Hydraulic / Hydrostatic System	102
Cold Temperature Starting	102
MONITORING THE DISPLAY PANELS	103
Left Panel	103
Warning And Shutdown	103
STOPPING THE ENGINE AND LEAVING THE LOADER	104
Procedure	104
COUNTERWEIGHTS	105
Description	105
Effect On The Loader And Loader Operation	105
When To Consider Using Counterweights	105
When To Consider Removing Counterweights	105
Accessories That Affect Machine Weight	105



ATTACHMENTS	106
Choosing The Correct Bucket	106
Pallet Fork	106
Installing And Removing The Attachment (Hand Lever Bob-Tach)	107
Installing And Removing The Attachment (Power Bob-Tach)	110
 OPERATING PROCEDURE	 113
Inspect The Work Area	113
Basic Operating Instructions	113
Driving On Public Roads	113
Operating With A Full Bucket	114
Operating With An Empty Bucket	114
 TOWING THE LOADER	 115
Procedure	115
 LIFTING THE LOADER	 115
Single-Point Lift	115
Four-Point Lift	116
 TRANSPORTING THE LOADER ON A TRAILER	 117
Loading And Unloading	117
Fastening	117

INTENDED USE

This machine is classified as a Skid-Steer Loader as defined in ISO 6165. This machine has wheels or tracks and commonly a front mounted bucket for the principle intended functions of digging, moving, leveling, lifting, carrying, and loading loose materials such as earth, gravel, or crushed rock.

Additional Bobcat approved attachments allow this machine to perform other tasks described in the attachment Operation & Maintenance Manuals.

Examples of intended use include:

Digging

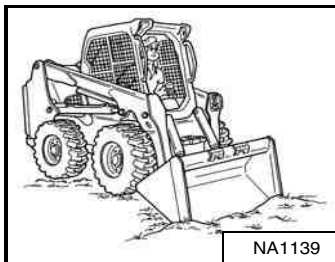

Backfilling

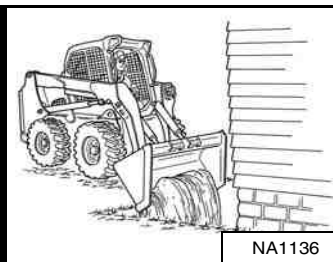

Leveling

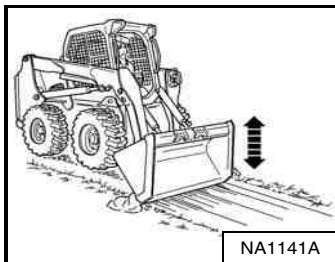

Piling Material



Loading Material



Moving Palletized Loads

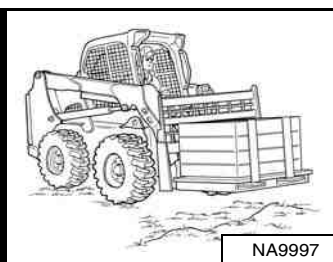

! WARNING

Load, unload and turn on flat level ground. Do not exceed Rated Operating Capacity (ROC) shown on sign (decal) in cab. Failure to obey warnings can cause the machine to tip or rollover and cause injury or death.

W-2056-1112

! WARNING

Never dump over an obstruction, such as a post, that can enter the operator cab. The machine could tip forward and cause injury or death.

W-2057-0694

IMPORTANT

Never drive forward when the hydraulic control for lift arms is in float position.

I-2005-1285

INSTRUMENT PANEL IDENTIFICATION

Overview

Figure 7



The left panel [Figure 7] is described in more detail. (See Left Panel on Page 38.)

Figure 8

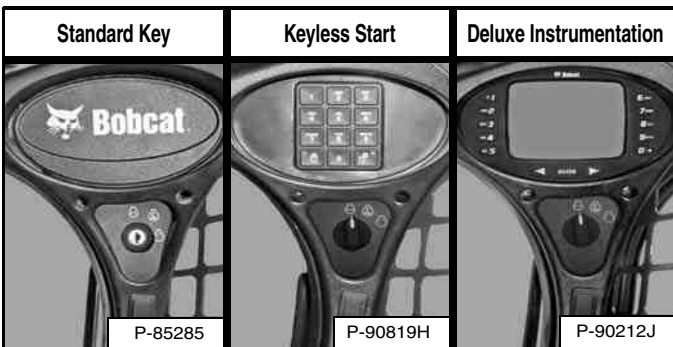

The right panel [Figure 8] is described in more detail. (See Right Panel (Standard Key Panel) on Page 41.), (See Right Panel (Keyless Start Panel) on Page 42.), or (See Right Panel (Deluxe Instrumentation Panel) on Page 43.)

Figure 9

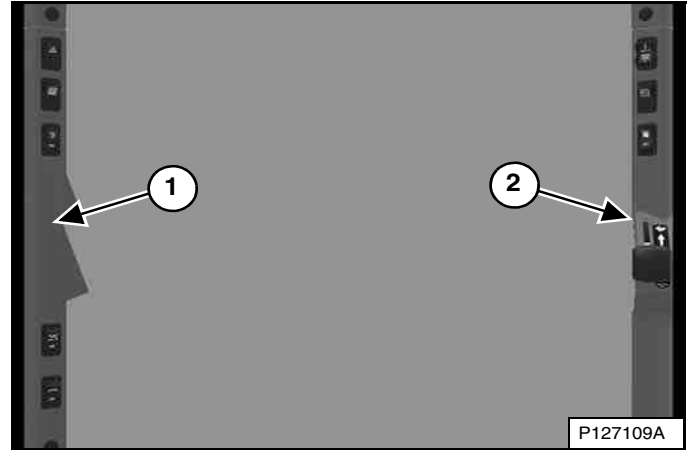

The left (Item 1) and right (Item 2) [Figure 9] switch panels are described in more detail. (See Left Switch Panel on Page 45.) and (See Right Switch Panel on Page 45.)

Figure 10

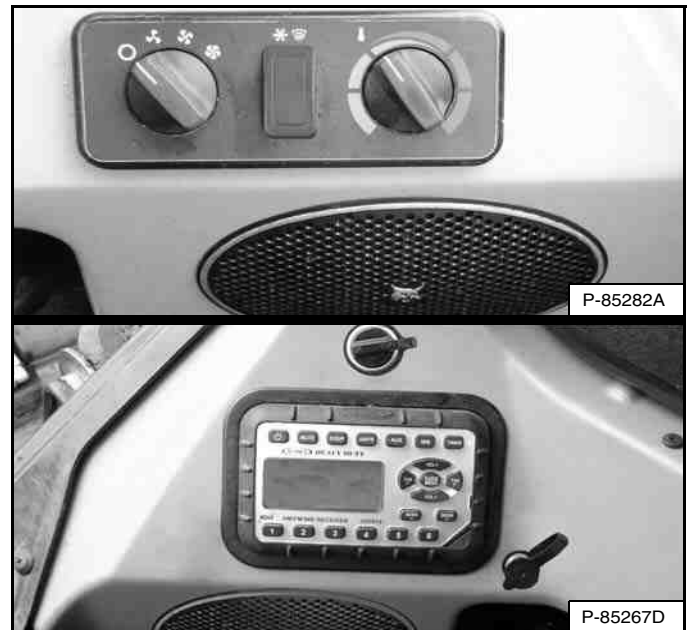

The left and right side lower panels [Figure 10] are described in more detail. (See Left Side Lower Panel on Page 46.) and (See Right Side Lower Panel on Page 46.)

INSTRUMENT PANEL IDENTIFICATION (CONT'D)

Left Panel

Figure 11

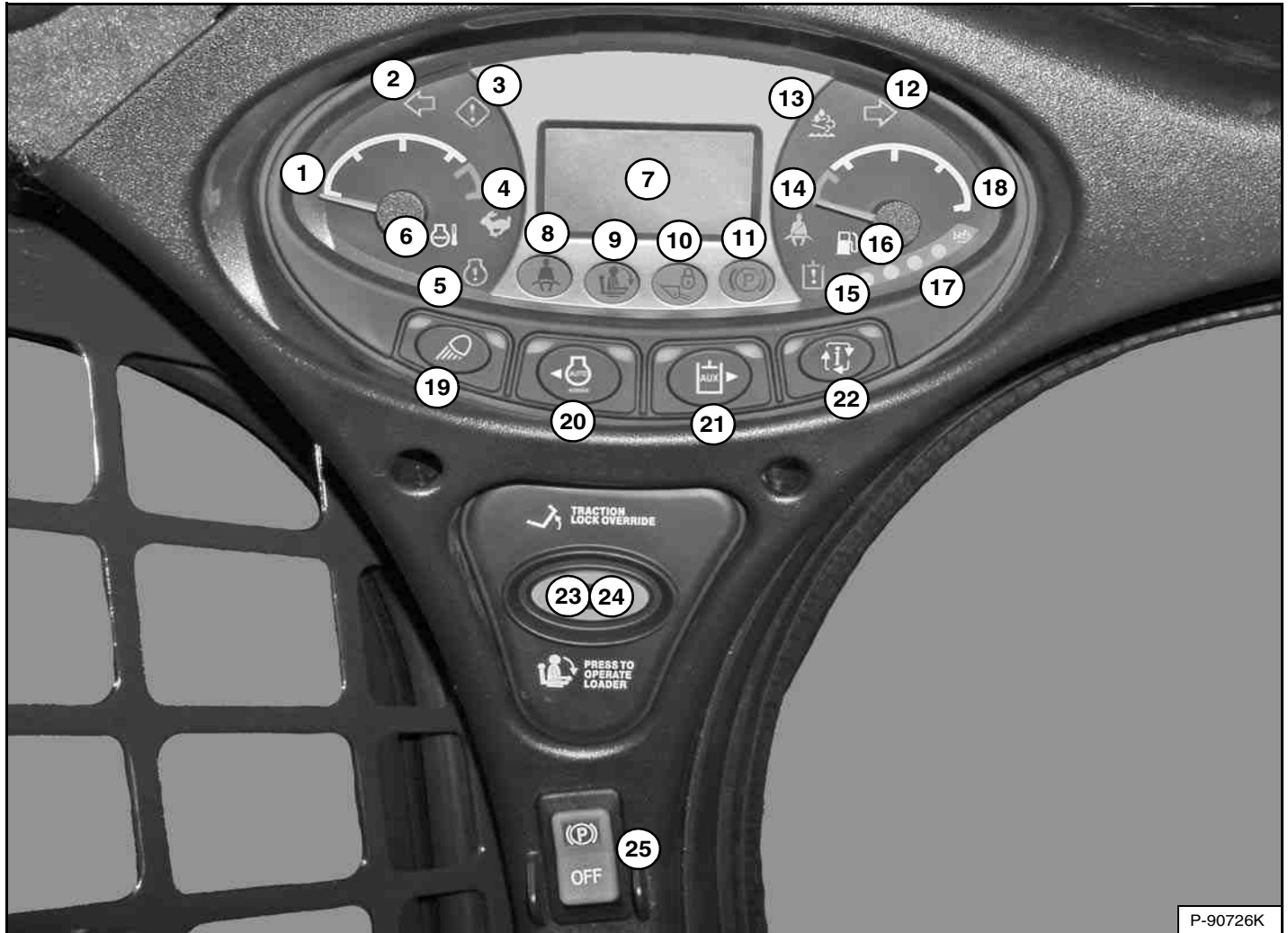

P-90726K

The left panel [Figure 11] is the same for all machines regardless of options and accessories.

REF. NO.	DESCRIPTION	FUNCTION / OPERATION
1	ENGINE TEMPERATURE GAUGE	Shows the engine coolant temperature.
2	LEFT TURN SIGNAL (Option)	Indicates left turn signals are ON.
3	GENERAL WARNING	Malfunction with one or more machine functions. (See Service Codes*)
4	TWO-SPEED (Option)	High range selected.
5	ENGINE MALFUNCTION	Engine malfunction or failure. (See Service Codes*)
6	ENGINE COOLANT TEMPERATURE	Engine coolant temperature high or sensor error.
7	DISPLAY SCREEN	Displays information. (See Display Screen in this manual.)
8	SEAT BELT	Instructs operator to fasten seat belt. Remains lit for 45 seconds.
9	SEAT BAR	The light is on when the seat bar is UP.
10	LIFT AND TILT VALVE	The light is on when the lift and tilt functions cannot be operated.
11	PARKING BRAKE	The light is on when the loader cannot be driven.



INSTRUMENT PANEL IDENTIFICATION (CONT'D)

Left Panel (Cont'd)

REF. NO.	DESCRIPTION	FUNCTION / OPERATION
12	RIGHT TURN SIGNAL (Option)	Indicates right turn signals are ON.
13	DIESEL PARTICULATE FILTER (DPF) / DIESEL EXHAUST FLUID (DEF)	Not used.
14	SHOULDER BELT (Option)	Instructs operator to fasten shoulder belt when operating in high range. Remains lit while in high range.
15	HYDRAULIC SYSTEM MALFUNCTION	Hydraulic system malfunction or failure. (See Service Codes*)
16	FUEL	Fuel level low or sensor error.
17	DIESEL EXHAUST FLUID (DEF) / AdBlue® LEVEL	Not used.
18	FUEL GAUGE	Shows the amount of fuel in the tank.
19	LIGHTS without road option	Press once for REAR taillights. (Right green LED will light.) Press a second time to turn FRONT and REAR work lights ON. REAR taillights will turn OFF. (Left green LED will light.) Press a third time to turn all lights off. (Left and right green LEDs will be off.)
	LIGHTS with road option	Press once for FRONT boom light, license plate light and REAR taillights. (Right green LED will light.) Press a second time to turn FRONT and REAR work lights ON. FRONT boom light, license plate light and REAR taillights will turn OFF. (Left green LED will light.) Press a third time to turn all lights off. (Left and right green LEDs will be off.)
		Press and hold 5 seconds to show software version in display screen.
20	AUTO IDLE	Not used.
		Move cursor to the left inside the DISPLAY SCREEN when using certain INFORMATION button menus.
21	AUXILIARY HYDRAULICS	Press once to activate the auxiliary hydraulic system. (Left green LED lights.) Press a second time to deactivate the system.
		Move cursor to the right inside the DISPLAY SCREEN when using certain INFORMATION button menus.
22	INFORMATION	Cycles through (after each button press): <ul style="list-style-type: none"> • Hourmeter (On startup) • Engine rpm • Battery voltage • Drive response menu • Steering drift compensation menu • Maintenance clock • Service codes*
23	TRACTION LOCK OVERRIDE	Functions only when the seat bar is raised and the engine is running. Press once to unlock the brakes. Allows you to use the steering levers or joystick(s) to move the loader forward or backward when using the backhoe attachment. (See TRACTION LOCK OVERRIDE in this manual.) Press a second time to lock the brakes.
24	PRESS TO OPERATE LOADER	Press to activate the BICS™ when the seat bar is down and operator is seated in operating position. Button will light.
25	PARKING BRAKE (Standard on all loaders)	Press the top to engage the Parking Brake. Press the bottom to disengage. (See PARKING BRAKE in this manual.)

* This manual contains a table with Service Code descriptions. (See DIAGNOSTIC SERVICE CODES on Page 184.)



INSTRUMENT PANEL IDENTIFICATION (CONT'D)

Display Screen

The display screen can display the following information:

- Operating hours
- Engine rpm
- Battery voltage
- Drive response setting
- Steering drift compensation setting
- Maintenance clock countdown
- Service codes
- Engine preheat countdown
- Speed management setting
- Lift and tilt compensation setting

Figure 12

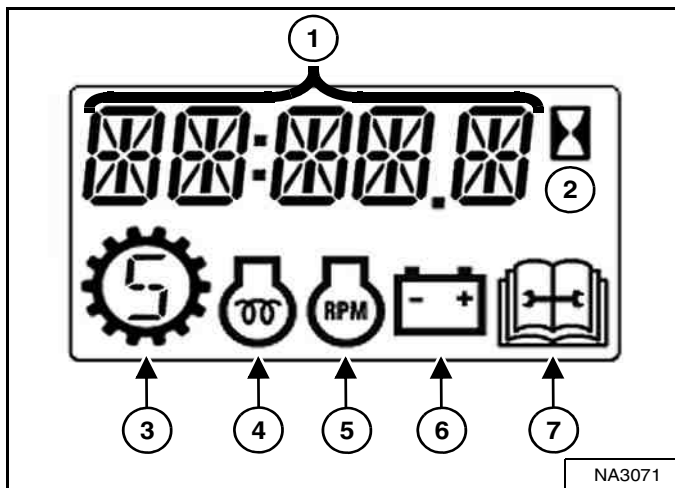

The display screen is shown in **[Figure 12]**. The data display will show operating hours upon startup.

1. **Data Display**
2. **Hourmeter**
3. **Speed Management**
4. **Engine Preheat**
5. **Engine RPM**
6. **Battery / Charging Voltage**
7. **Service**

INSTRUMENT PANEL IDENTIFICATION (CONT'D)

Right Panel (Standard Key Panel)

Figure 13



This machine may be equipped with a Standard Key Panel [Figure 13].

The Standard Key Panel has a key switch (Item 1) [Figure 13] used to turn the loaders electrical system on and off, and to start and stop the engine.

The switch location (Item 2) [Figure 13] can have different functions depending on machine configuration. See the following table for more information.

REF. NO.	DESCRIPTION	FUNCTION / OPERATION
	ADVANCED CONTROL SYSTEM (ACS) (Option)	Press the top to select Hand Controls; bottom to select Foot Controls.
	SELECTABLE JOYSTICK CONTROLS (SJC) (Option)	Press the top to select 'ISO' Control Pattern; bottom to select 'H' Control Pattern.
	FOUR-WAY FLASHER LIGHTS (Option)	Press the top to turn lights ON; bottom to turn OFF.
	ROTATING BEACON (Option) <i>or</i> STROBE LIGHT (Option)	Press the top to turn light ON; bottom to turn OFF.

INSTRUMENT PANEL IDENTIFICATION (CONT'D)

Right Panel (Keyless Start Panel)

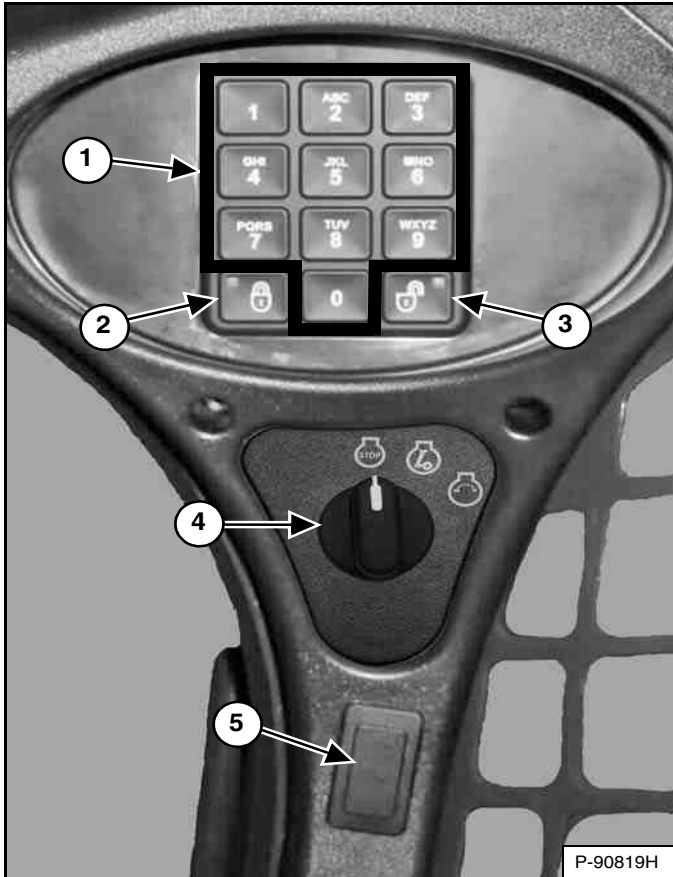
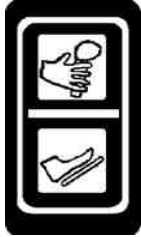
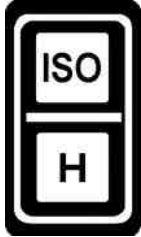

Figure 14



This machine may be equipped with a Keyless Start Panel [Figure 14].

1. **Keypad (keys 1 through 0):** Used to enter a number code (password) to allow starting the engine. An asterisk will show in the left panel display screen for each key press.
2. **LOCK Key:** Used to lock keypad. The lock key will display a red light to indicate a password is required to start the loader. (See Password Lockout Feature on Page 195.)
3. **UNLOCK Key:** Used to unlock keypad. The unlock key will display a green light to indicate the loader can be started without a password. (See Password Lockout Feature on Page 195.)
4. **Key Switch:** Used to turn the loaders electrical system on and off, and to start and stop the engine.

The switch location (Item 5) [Figure 14] can have different functions depending on machine configuration. See the following table for more information.

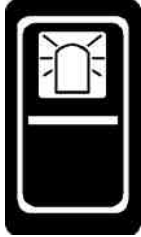
REF. NO.	DESCRIPTION	FUNCTION / OPERATION
	ADVANCED CONTROL SYSTEM (ACS) (Option)	Press the top to select Hand Controls; bottom to select Foot Controls.
	SELECTABLE JOYSTICK CONTROLS (SJC) (Option)	Press the top to select 'ISO' Control Pattern; bottom to select 'H' Control Pattern.
	FOUR-WAY FLASHER LIGHTS (Option)	Press the top to turn lights ON; bottom to turn OFF.
	ROTATING BEACON (Option) or STROBE LIGHT (Option)	Press the top to turn light ON; bottom to turn OFF.

INSTRUMENT PANEL IDENTIFICATION (CONT'D)

Right Panel (Deluxe Instrumentation Panel)

Figure 15

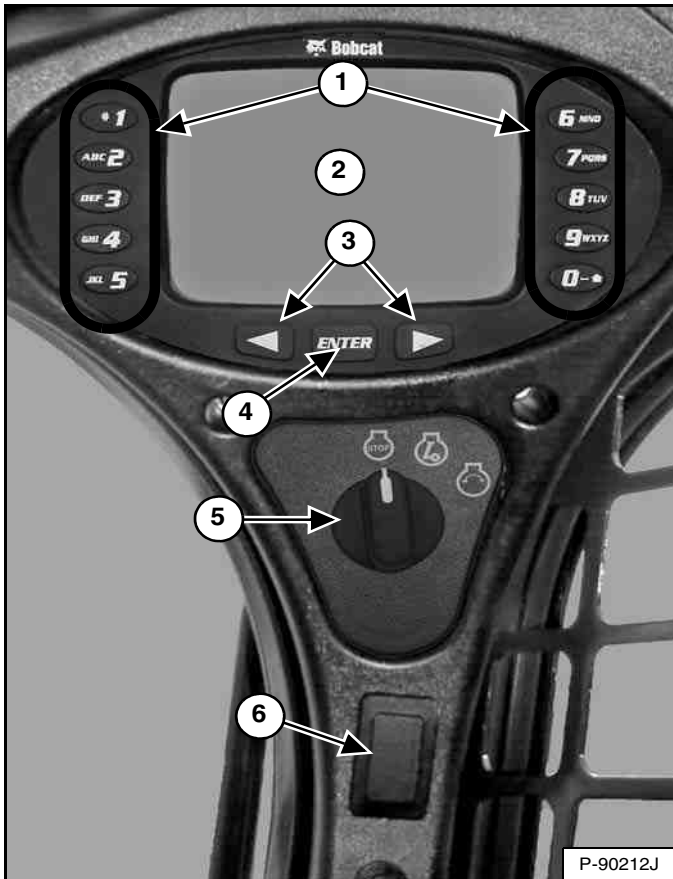

This machine may be equipped with a Deluxe Instrumentation Panel [Figure 15].

1. **Keypad (keys 1 through 0):** The keypad has two functions:
 - To enter a number code (password) to allow starting the engine.
 - To enter a number as directed for further use of the display screen.
2. **Display Screen:** The display screen is where all system setup, monitoring, and error conditions are displayed.
3. **Scroll Buttons:** Used to scroll through display screen choices.
4. **ENTER Button:** Used to make selections on the display screen.
5. **Key Switch:** Used to turn the loaders electrical system on and off, and to start and stop the engine.

The switch location (Item 6) [Figure 15] can have different functions depending on machine configuration. See the following table for more information.

REF. NO.	DESCRIPTION	FUNCTION / OPERATION
	ADVANCED CONTROL SYSTEM (ACS) (Option)	Press the top to select Hand Controls; bottom to select Foot Controls.
	SELECTABLE JOYSTICK CONTROLS (SJC) (Option)	Press the top to select 'ISO' Control Pattern; bottom to select 'H' Control Pattern.
	FOUR-WAY FLASHER LIGHTS (Option)	Press the top to turn lights ON; bottom to turn OFF.
	ROTATING BEACON (Option) <i>or</i> STROBE LIGHT (Option)	Press the top to turn light ON; bottom to turn OFF.

INSTRUMENT PANEL IDENTIFICATION (CONT'D)

Right Panel (Deluxe Instrumentation Panel) (Cont'd)

Figure 16



The first screen you will see on your new loader is shown in [Figure 16].

When this screen is on the display you can enter the password and start the engine or change the default language.

NOTE: Your new loader (with Deluxe Instrumentation Panel) will have an Owner Password. Your dealer will provide you with this password. Change the password to one that you will easily remember to prevent unauthorised use of your loader. (See Changing The Owner Password on Page 196.) Keep your password in a safe location for future needs.

Change Language:

Press the left or right scroll button to cycle through the languages. The language that is stopped on becomes the default language used for the Deluxe Instrumentation Panel [Figure 16].

The language can be changed at any time. (See CONTROL PANEL SETUP on Page 191.)

Enter The Password:

Use the numbers on the keypad to enter the password, then press the [ENTER] button. A symbol will appear on the display screen for each number entered. The left scroll button can be used to backspace if an incorrect number is entered.

If the correct password is not entered, [INVALID PASSWORD TRY AGAIN] will appear on the display screen and the password will have to be reentered.

See CONTROL PANEL SETUP for further description of screens to set up the system for your use. (See CONTROL PANEL SETUP on Page 191.)



INSTRUMENT PANEL IDENTIFICATION (CONT'D)

Left Switch Panel

Right Switch Panel

Figure 17

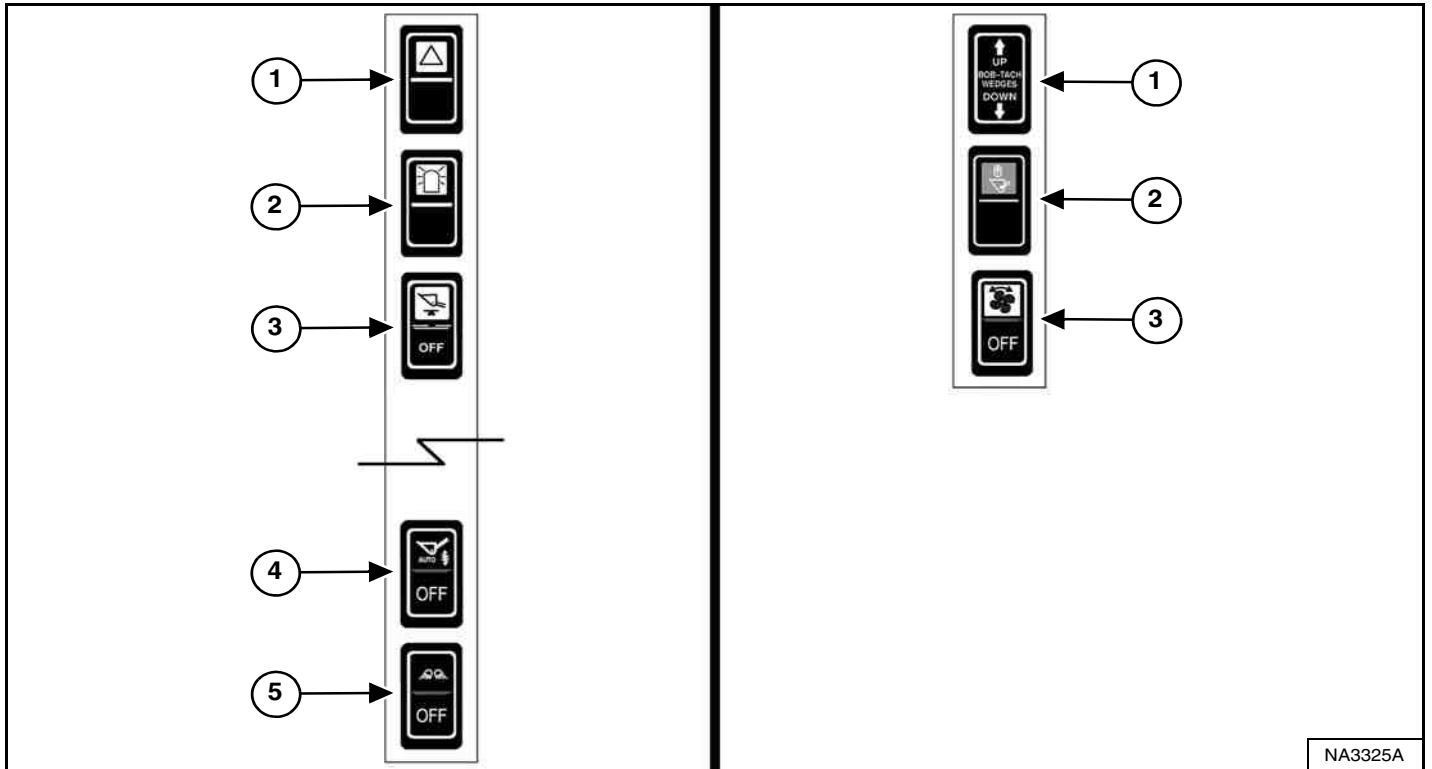

ITEM	DESCRIPTION	FUNCTION / OPERATION
1	FOUR-WAY FLASHER LIGHTS (Option)	Press the top to turn lights ON; bottom to turn OFF.
2	ROTATING BEACON (Option) OR STROBE LIGHT (Option)	Press the top to turn light ON; bottom to turn OFF.
3	HYDRAULIC BUCKET POSITIONING (Option)	Press the top to engage Hydraulic Bucket Positioning; bottom to disengage.
4	AUTOMATIC RIDE CONTROL (Option)	Press the top to engage Automatic Ride Control; bottom to disengage.
5	SIDE LIGHTING (Option)	Press the top to turn lights ON; bottom to turn OFF. NOTE: Turn side lighting OFF when driving on public roads.

ITEM	DESCRIPTION	FUNCTION / OPERATION
1	POWER BOB-TACH (Option)	Press and hold the up arrow to disengage the Bob-Tach wedges. Press and hold the down arrow to engage the Bob-Tach wedges into the attachment mounting frame holes.
2	TRAVEL LOCK	Press the top of the switch to lock the lift and tilt hydraulic functions for travel. Press the bottom of the switch to turn travel lock OFF.
3	REVERSING FAN (Option)	Automatic Operation - middle position; Manual Operation - press top momentarily; press bottom to disengage.

NOTE: Earlier models did not have switch locations four and five on the left switch panel.

INSTRUMENT PANEL IDENTIFICATION (CONT'D)

Left Side Lower Panel

Figure 18

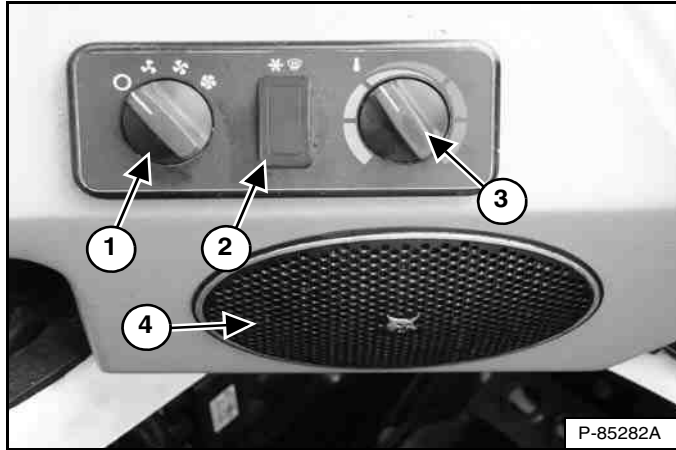

Right Side Lower Panel

Figure 19

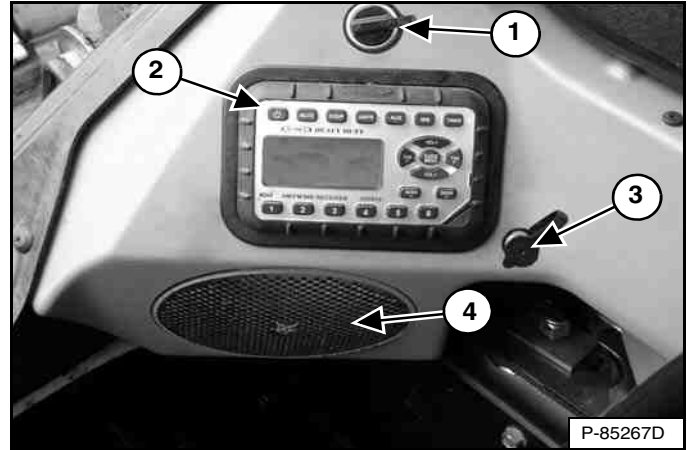

REF. NO.	DESCRIPTION	FUNCTION / OPERATION
1	FAN MOTOR (Option)	Turn clockwise to increase fan speed; anticlockwise to decrease. There are four positions; OFF-1-2-3.
2	NOT USED	---
3	TEMPERATURE CONTROL (Option)	Turn clockwise to increase the temperature; anticlockwise to decrease.
4	SPEAKER (Option)	Left speaker used with optional radio.

REF. NO.	DESCRIPTION	FUNCTION / OPERATION
1	POWER PORT	Provides a 12 volt receptacle for accessories.
2	RADIO (Option)	See Radio in this manual.
3	HEADPHONE JACK (Option)	Used to connect headphones to the optional radio output. Automatically silences speakers when used.
4	SPEAKER (Option)	Right speaker used with optional radio.

INSTRUMENT PANEL IDENTIFICATION (CONT'D)

Radio

This machine may be equipped with a radio.

Figure 20

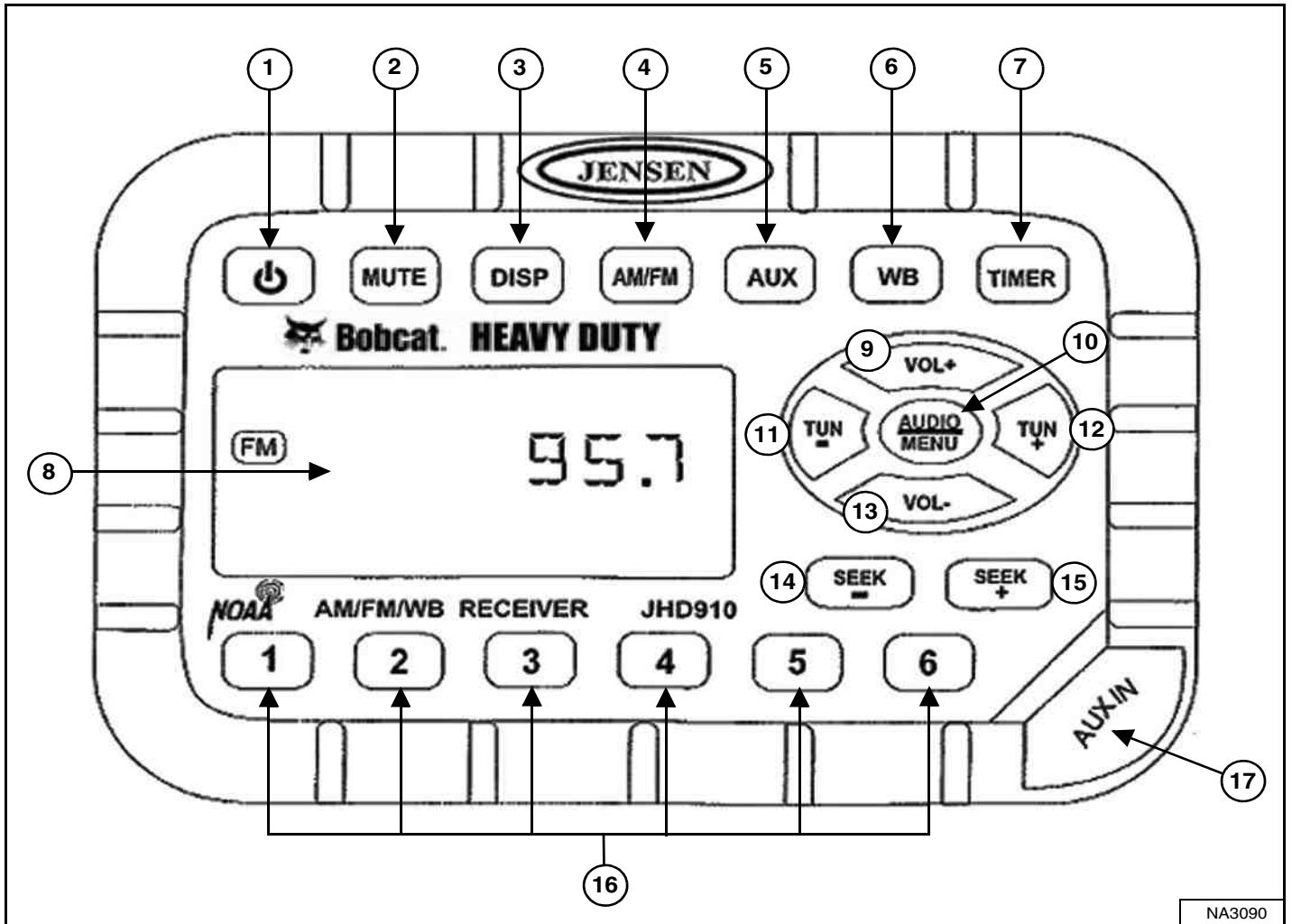

The table on the next page shows the DESCRIPTION and FUNCTION / OPERATION for each of the controls of the radio [Figure 20].

NOTE: See DISPLAY in the table for clock setting instructions.



INSTRUMENT PANEL IDENTIFICATION (CONT'D)

Radio (Cont'd)

REF. NO.	DESCRIPTION	FUNCTION / OPERATION
1	POWER	Press to turn ON; press again to turn OFF.
2	MUTE	Press to mute audio output; [MUTE] will appear in display screen; press again to turn OFF.
3	DISPLAY	Press to toggle between function mode (showing tuner frequency, auxiliary input, weather band information, or timer) and clock mode.
		Press and hold to enter clock setting mode; use FREQUENCY DOWN (TUN -) button to adjust hours and FREQUENCY UP (TUN +) button to adjust minutes; normal operation will resume automatically.
4	BAND	Press to select tuner mode. Press to cycle through 2 AM (MW) bands and 3 FM bands.
5	AUXILIARY	Press to select Auxiliary Input mode. Portable audio device (MP3 player) must be attached to auxiliary input jack.
6	WEATHER BAND	Press to select weather band; use FREQUENCY UP (TUN +) and FREQUENCY DOWN (TUN -) buttons to adjust to the clearest station. The weather alert feature, if activated, will automatically switch from the current function to the weather band if a weather warning is received. See AUDIO / MENU ADJUSTMENT in this table.
7	TIMER	Press to access timer mode. Press to start the timer function; press again to stop timer; press again to resume timer or press and hold to reset timer and exit from timer mode.
8	DISPLAY SCREEN	Displays the time, frequency, and activated functions.
9	VOLUME UP	Adjusts volume up; current volume (0 - 40) will appear briefly in display screen.
10	AUDIO / MENU ADJUSTMENT	AUDIO ADJUSTMENT: Press to cycle through bass, treble, and balance settings; use VOLUME UP (VOL +) and VOLUME DOWN (VOL -) buttons to adjust when desired option is displayed; normal operation will resume automatically. MENU ADJUSTMENT: Press and hold for 3 seconds to enter menu adjustment settings; press to cycle through the following settings; use VOLUME UP (VOL +) and VOLUME DOWN (VOL -) buttons to adjust when desired option is displayed; normal operation will resume automatically. <ul style="list-style-type: none"> • Beep Confirm (On or Off) - Determines if beep will sound with each button press. • Operation Region (USA or Europe) - Selects the appropriate region. • Clock Display (12 or 24) - Selects a 12-hour or 24-hour clock display. • Display Brightness (Low, Medium, or High) - Determines brightness level of display screen. • Backlight Colour (Amber or Green) - Determines backlight colour of display screen. • Power On Volume (0 - 40) - Selects default volume setting when radio is turned on. • WB Alert (On or Off) - Determines if weather band alert feature is activated.
11	FREQUENCY DOWN	Press to manually tune the radio frequency down.
12	FREQUENCY UP	Press to manually tune the radio frequency up.
13	VOLUME DOWN	Adjusts volume down; current volume (0 - 40) will appear briefly in display screen.
14	SEEK FREQUENCY DOWN	Press to automatically tune frequency down to next strong station.
15	SEEK FREQUENCY UP	Press to automatically tune frequency up to next strong station.
16	PRESET STATIONS	Used to store and recall stations for each AM and FM band. Press and hold to store current station; press button to recall station.
17	AUXILIARY INPUT JACK	Connect line output of portable audio device (MP3 player) to 3,5 mm (1/8 in) jack and press AUXILIARY button.

INSTRUMENT PANEL IDENTIFICATION (CONT'D)

Rear View Camera System

This machine may be equipped with a rear view camera system.

A rear view camera system is not a substitute for keeping bystanders away from the work area. Operators must remain fully aware of the surroundings using direct visibility and the rear view camera system. The operator must service and maintain the camera system to ensure proper function.

Figure 21

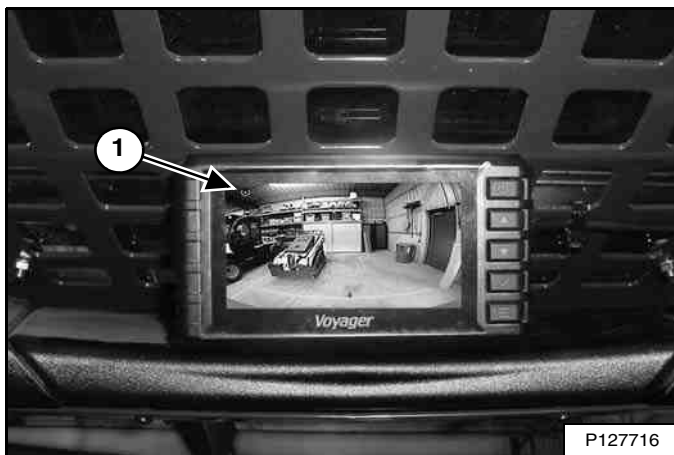

The camera display is located above the front door [Figure 21].

NOTE: Objects viewed on the camera display are closer than they appear.

The rotating icon (Item 1) [Figure 21] in the upper left corner of the display indicates a live broadcast from the camera.

If the icon freezes, it indicates that the camera is not supplying a live broadcast and service may be required.

WARNING

AVOID INJURY OR DEATH

- Always keep bystanders away from the work area and travel path.
- The operator must maintain a clear view of the direction of travel and look before and during machine movement.
- The back-up alarm must sound when operating the machine in the reverse direction.

W-2783-0118

Figure 22

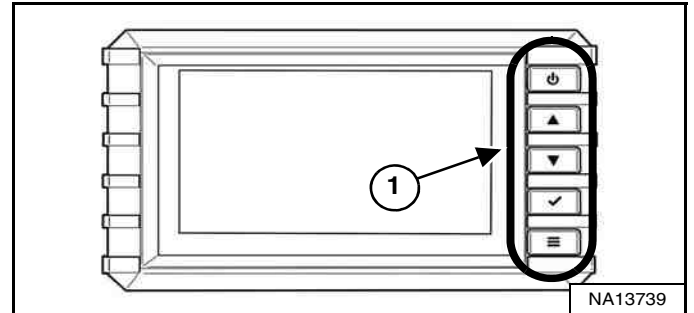

The table below explains the function of each button (Item 1) [Figure 22] on the camera display.

ITEM	DESCRIPTION	FUNCTION / OPERATION
	POWER	Press to turn display ON; press again to turn OFF.
	UP	Press to navigate up through menu screen choices; also used to adjust menu settings.
	DOWN	Press to navigate down through menu screen choices; also used to adjust menu settings.
	SELECT	Press to select the highlighted function or option setting. Pressing the select button while on the main screen will change the camera input to a blank screen labeled CAM2 or CAM3. Press the button until the input is returned to CAM1 for normal system operation.
	MENU	Press to enter the menu settings; also used to return to previous menu.

Commonly used menu settings:

- PICTURE - Brightness, contrast, color, tint
- SETTING - Screen saver, auto power
- MISCELLANEOUS - Language, reset.

INSTRUMENT PANEL IDENTIFICATION (CONT'D)

Rear View Camera System (Cont'd)

Figure 23

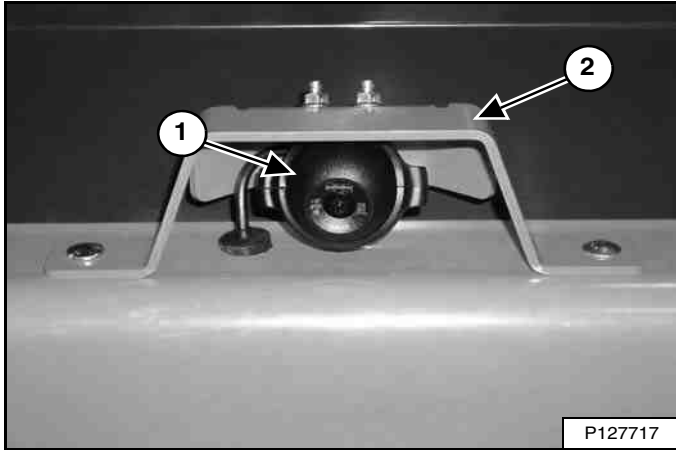

The rear camera (Item 1) is located inside a bracket (Item 2) [Figure 23] mounted on top of the rear door.

Perform the following daily or as needed:

- Clean the lens of the camera using a soft cloth and clean water.
- Remove mud, snow, ice or other debris that could affect the clear view provided by the camera system.
- Verify proper camera adjustment. Adjust camera if needed.
- Replace damaged rear view camera system components. See your Bobcat dealer for service and parts.

Rear Camera Adjustment

Figure 24

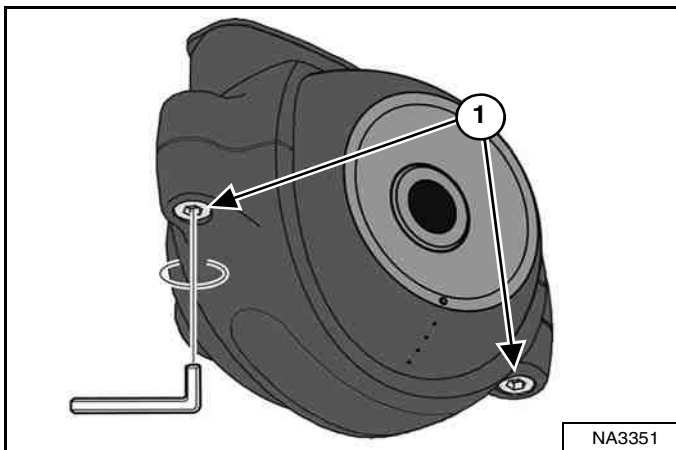

Perform the following steps to adjust the rear camera:

1. Make a mark on the ground 1,25 m (4 ft) behind the machine.
2. Loosen the screws (Item 1) [Figure 24] of the clamp holding the camera.
3. Turn the key switch to **RUN** **without starting the engine**. Turn the display ON.

Figure 25

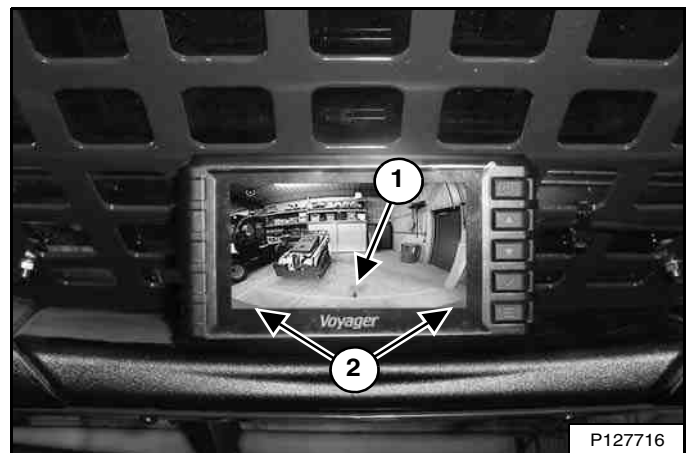

4. Look at the camera display through the rear window of the machine. The image should be as a mirror, an object to the left of the machine appears on the left of the display. See display menu to adjust if needed.
5. Adjust the camera down until the rear door (Item 2) is just visible on the display. Ensure the camera is centered left and right. The mark on the ground (Item 1) [Figure 25] from step 1 should be visible on the display.
6. Tighten the screws to 0,8 – 1,0 N•m (7 – 8.8 in-lb) torque.
7. Turn the key switch to OFF.

CONTROL IDENTIFICATION

Description

This loader has four control configurations available to operate lift / tilt functions and driving / steering the loader:

- Standard Controls - Uses foot pedals for lift and tilt functions.
Uses steering levers for driving and steering the loader.
- Advanced Control System (ACS) (Option) - Uses a choice of foot pedals or handles for lift and tilt functions.
Uses steering levers for driving and steering the loader.
- Advanced Hand Controls (AHC) (Option) - Uses handles for lift and tilt functions.
Uses steering levers for driving and steering the loader.
- Selectable Joystick Controls (SJC) (Option) - Uses joysticks for lift / tilt functions and driving / steering the loader.

Standard Controls

Figure 26

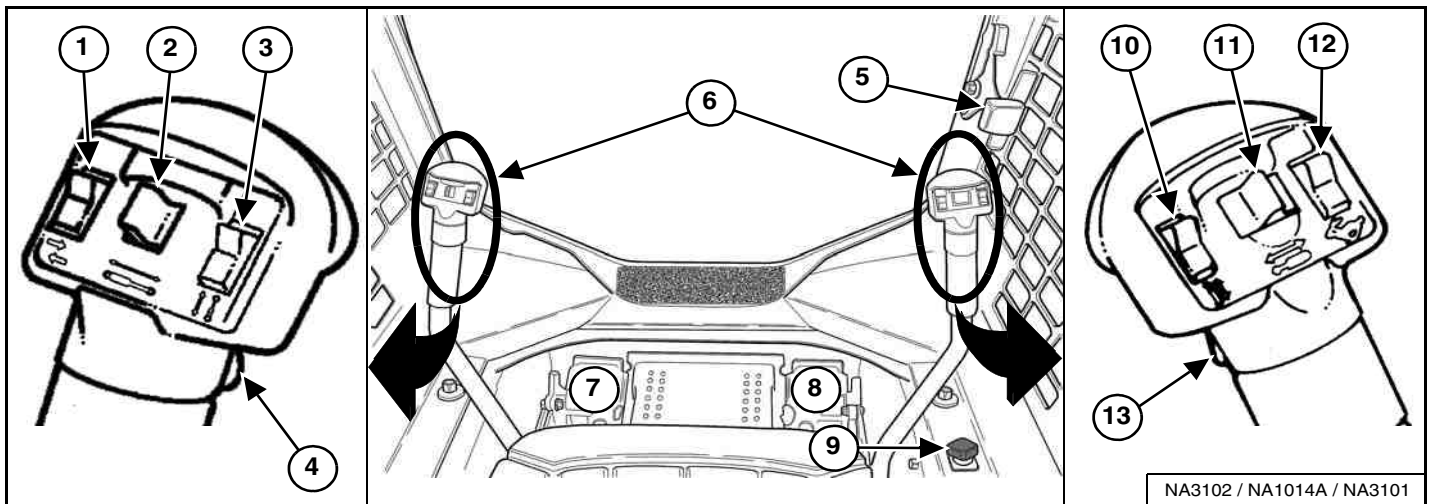

REF. NO.	DESCRIPTION	FUNCTION / OPERATION
1	TURN SIGNALS (Option)	Press the top to activate right signal; bottom to activate left signal; centre position to turn off.
2	REAR AUXILIARY HYDRAULICS (Option) Also: ATTACHMENT FUNCTION CONTROL	See REAR Auxiliary Hydraulics Operation in this manual. See ATTACHMENT CONTROL DEVICE in this manual.
3	ATTACHMENT FUNCTION CONTROL	See ATTACHMENT CONTROL DEVICE in this manual.
4	FRONT HORN	Press the front switch to sound the front horn.
5	ENGINE SPEED CONTROL	See ENGINE SPEED CONTROL in this manual.
6	STEERING LEVERS	See DRIVING AND STEERING THE LOADER in this manual.
7	LIFT ARM PEDAL	See HYDRAULIC CONTROLS in this manual.
8	TILT PEDAL	See HYDRAULIC CONTROLS in this manual.
9	LIFT ARM BYPASS CONTROL	See LIFT ARM BYPASS CONTROL in this manual.
10	ATTACHMENT FUNCTION CONTROL	See ATTACHMENT CONTROL DEVICE in this manual.
11	FRONT AUXILIARY HYDRAULICS	See FRONT Auxiliary Hydraulics Operation in this manual.
12	TWO-SPEED CONTROL (Option)	See TWO-SPEED CONTROL in this manual.
13	CONTINUOUS FLOW CONTROL FOR AUXILIARY HYDRAULICS	See FRONT Auxiliary Hydraulics Operation (CONTINUOUS FLOW) in this manual.

CONTROL IDENTIFICATION (CONT'D)

Advanced Control System (ACS)

Figure 27

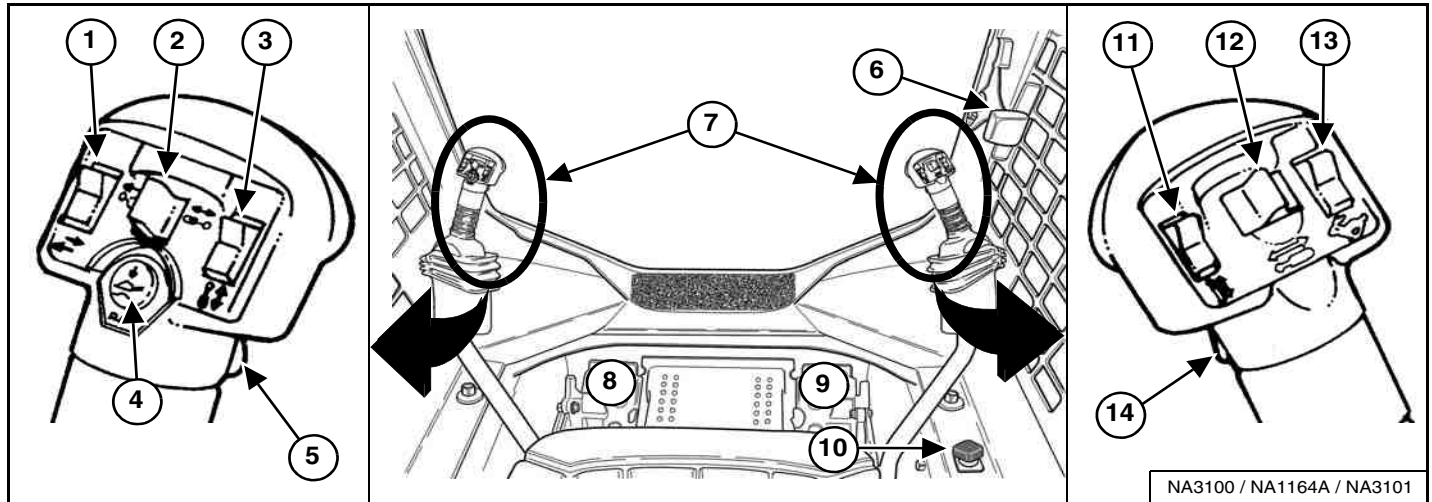

REF. NO.	DESCRIPTION	FUNCTION / OPERATION
1	TURN SIGNALS (Option)	Press the top to activate right signal; bottom to activate left signal; centre position to turn off.
2	REAR AUXILIARY HYDRAULICS (Option) Also: ATTACHMENT FUNCTION CONTROL	See REAR Auxiliary Hydraulics Operation in this manual. See ATTACHMENT CONTROL DEVICE in this manual.
3	ATTACHMENT FUNCTION CONTROL	See ATTACHMENT CONTROL DEVICE in this manual.
4	FLOAT CONTROL	See HYDRAULIC CONTROLS in this manual.
5	FRONT HORN	Press the front switch to sound the front horn.
6	ENGINE SPEED CONTROL	See ENGINE SPEED CONTROL in this manual.
7	STEERING LEVERS and LIFT / TILT HANDLES	See DRIVING AND STEERING THE LOADER and HYDRAULIC CONTROLS in this manual.
8	LIFT ARM PEDAL	See HYDRAULIC CONTROLS in this manual.
9	TILT PEDAL	See HYDRAULIC CONTROLS in this manual.
10	LIFT ARM BYPASS CONTROL	See LIFT ARM BYPASS CONTROL in this manual.
11	ATTACHMENT FUNCTION CONTROL	See ATTACHMENT CONTROL DEVICE in this manual.
12	FRONT AUXILIARY HYDRAULICS	See FRONT Auxiliary Hydraulics Operation in this manual.
13	TWO-SPEED CONTROL (Option)	See TWO-SPEED CONTROL in this manual.
14	CONTINUOUS FLOW CONTROL FOR AUXILIARY HYDRAULICS	See FRONT Auxiliary Hydraulics Operation (CONTINUOUS FLOW) in this manual.

CONTROL IDENTIFICATION (CONT'D)

Advanced Hand Controls (AHC)

Figure 28

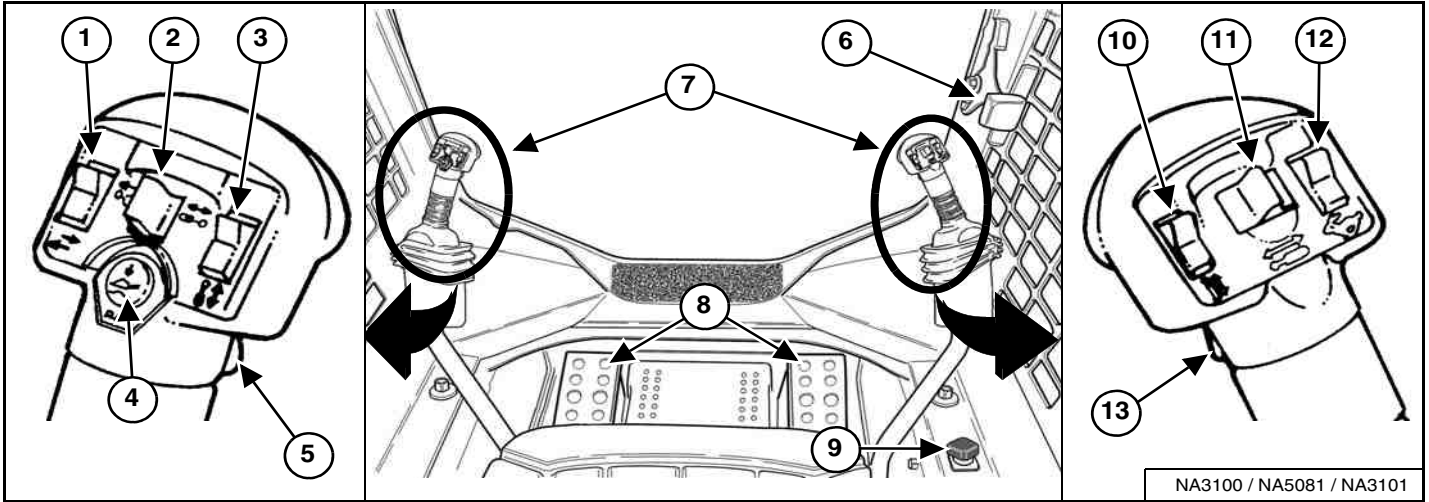

REF. NO.	DESCRIPTION	FUNCTION / OPERATION
1	TURN SIGNALS (Option)	Press the top to activate right signal; bottom to activate left signal; centre position to turn off.
2	REAR AUXILIARY HYDRAULICS (Option) Also: ATTACHMENT FUNCTION CONTROL	See REAR Auxiliary Hydraulics Operation in this manual. See ATTACHMENT CONTROL DEVICE in this manual.
3	ATTACHMENT FUNCTION CONTROL	See ATTACHMENT CONTROL DEVICE in this manual.
4	FLOAT CONTROL	See HYDRAULIC CONTROLS in this manual.
5	FRONT HORN	Press the front switch to sound the front horn.
6	ENGINE SPEED CONTROL	See ENGINE SPEED CONTROL in this manual.
7	STEERING LEVERS AND LIFT / TILT HANDLES	See DRIVING AND STEERING THE LOADER and HYDRAULIC CONTROLS in this manual.
8	FOOTRESTS	Keep your feet on the footrests at all times.
9	LIFT ARM BYPASS CONTROL	See LIFT ARM BYPASS CONTROL in this manual.
10	ATTACHMENT FUNCTION CONTROL	See ATTACHMENT CONTROL DEVICE in this manual.
11	FRONT AUXILIARY HYDRAULICS	See FRONT Auxiliary Hydraulics Operation in this manual.
12	TWO-SPEED CONTROL (Option)	See TWO-SPEED CONTROL in this manual.
13	CONTINUOUS FLOW CONTROL FOR AUXILIARY HYDRAULICS	See FRONT Auxiliary Hydraulics Operation (CONTINUOUS FLOW) in this manual.



CONTROL IDENTIFICATION (CONT'D)

Selectable Joystick Controls (SJC)

Figure 29

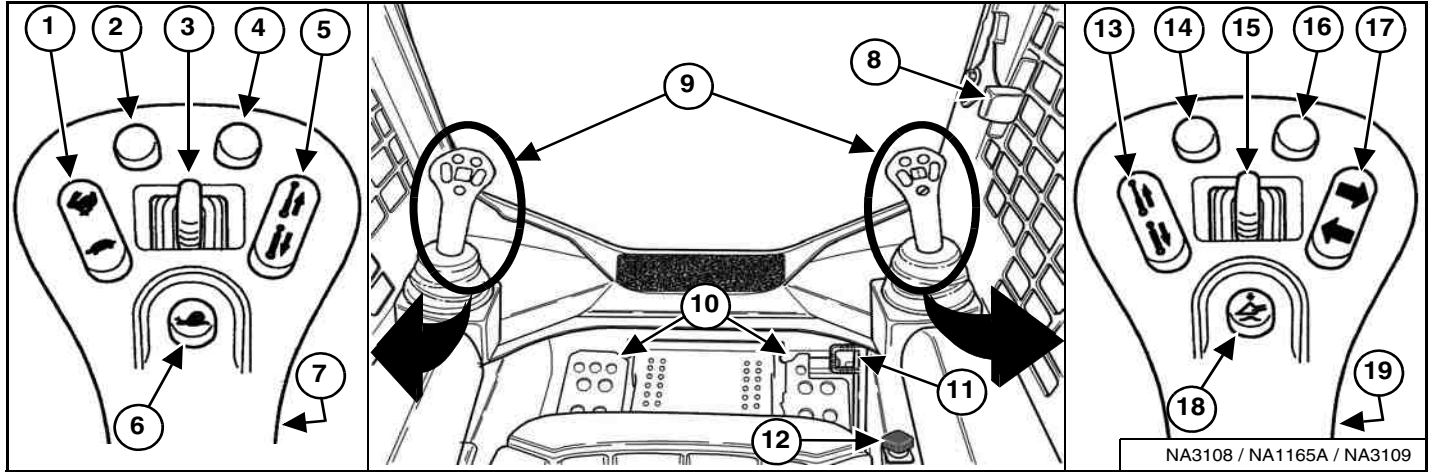

REF. NO.	DESCRIPTION	FUNCTION / OPERATION
1	TWO-SPEED CONTROL (Option) Also: SPEED MANAGEMENT	See TWO-SPEED CONTROL in this manual. See SPEED MANAGEMENT in this manual.
2 *	STEERING DRIFT COMPENSATION Also: DRIVE RESPONSE	See STEERING DRIFT COMPENSATION in this manual. See DRIVE RESPONSE in this manual.
3	REAR AUXILIARY HYDRAULICS (Option) Also: ATTACHMENT FUNCTION CONTROL	See REAR Auxiliary Hydraulics Operation in this manual. See ATTACHMENT CONTROL DEVICE in this manual.
4 *	STEERING DRIFT COMPENSATION Also: DRIVE RESPONSE	See STEERING DRIFT COMPENSATION in this manual. See DRIVE RESPONSE in this manual.
5	ATTACHMENT FUNCTION CONTROL	See ATTACHMENT CONTROL DEVICE in this manual.
6	SPEED MANAGEMENT	See SPEED MANAGEMENT in this manual.
7	FRONT HORN	Press the front switch to sound the front horn.
8	ENGINE SPEED CONTROL (HAND)	See ENGINE SPEED CONTROL in this manual.
9	JOYSTICKS	See DRIVING AND STEERING THE LOADER and HYDRAULIC CONTROLS in this manual.
10	FOOTRESTS	Keep your feet on the footrests at all times.
11	ENGINE SPEED CONTROL (FOOT)	See ENGINE SPEED CONTROL in this manual.
12	LIFT ARM BYPASS CONTROL	See LIFT ARM BYPASS CONTROL in this manual.
13	ATTACHMENT FUNCTION CONTROL	See ATTACHMENT CONTROL DEVICE in this manual.
14 *	NOT USED	- - -
15	FRONT AUXILIARY HYDRAULICS	See FRONT Auxiliary Hydraulics Operation in this manual.
16 *	NOT USED	- - -
17	TURN SIGNALS (Option)	Press the top to activate right signal; press again to turn off. Press the bottom to activate left signal; press again to turn off.
18	FLOAT CONTROL	See HYDRAULIC CONTROLS in this manual.
19	CONTINUOUS FLOW CONTROL FOR AUXILIARY HYDRAULICS	See FRONT Auxiliary Hydraulics Operation (CONTINUOUS FLOW) in this manual.

* Also used as Attachment Function Control: See your attachment Operation & Maintenance Manual.

OPERATOR CAB

Description

The Bobcat loader has an operator cab (ROPS and FOPS) as standard equipment to protect the operator from rollover and falling objects. The seat belt must be worn for rollover protection.

WARNING

Never modify operator cab by welding, grinding, drilling holes or adding attachments unless instructed to do so by Bobcat Company. Changes to the cab can cause loss of operator protection from rollover and falling objects, and result in injury or death.

W-2069-0200

Side Windows

Figure 30

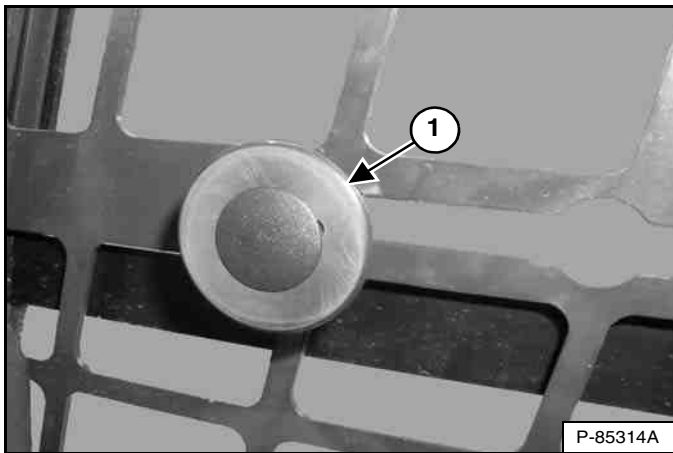

Pull the knob (Item 1) [Figure 30] and slide backward to open window. Release knob at cutout to lock in desired position. Pull the knob and slide forward to close window.

Door Operation

This machine may be equipped with a front door.

Figure 31

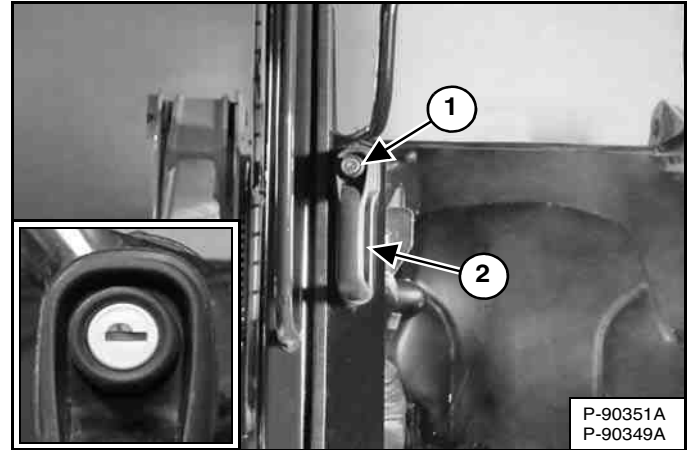

Push the knob (Item 1) and pull the handle (Item 2) to open the front door. A lock is provided in the knob (Inset [Figure 31]) to lock the front door when the loader is not in use.

Figure 32

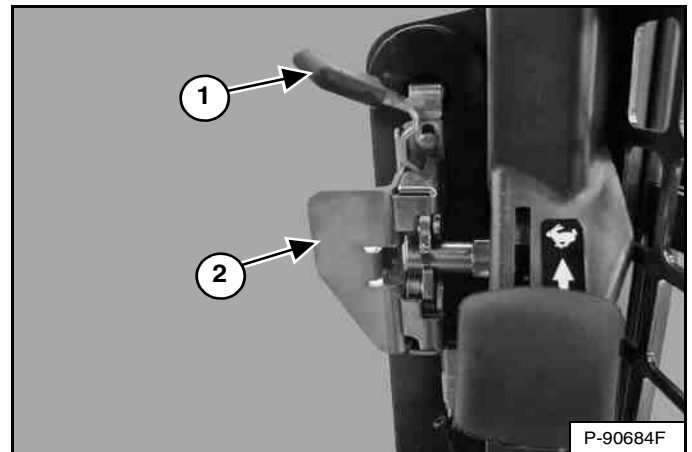

Pull the front door closed using the handle (Item 2) [Figure 32].

Pull the lever (Item 1) toward you to unlatch the front door. Push on the handle (Item 2) [Figure 32] to open the front door.

OPERATOR CAB (CONT'D)

Front Wiper

This machine may be equipped with a front wiper.

Figure 33

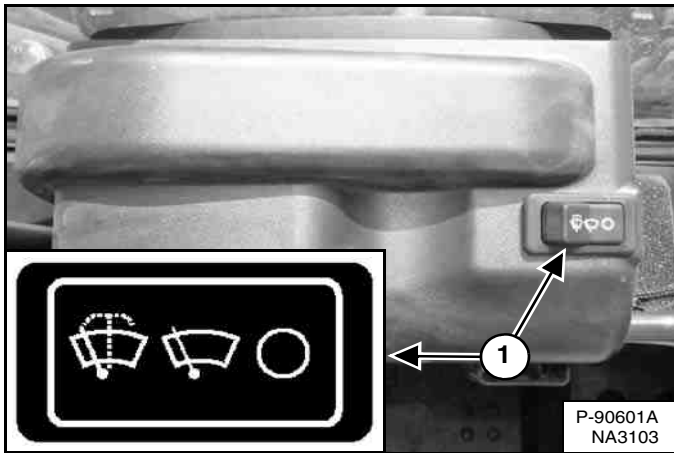

Press the left side of the switch (Item 1) [Figure 33] to start the front wiper (press and hold for washer fluid). Press the right side of the switch to stop the wiper.

Figure 34

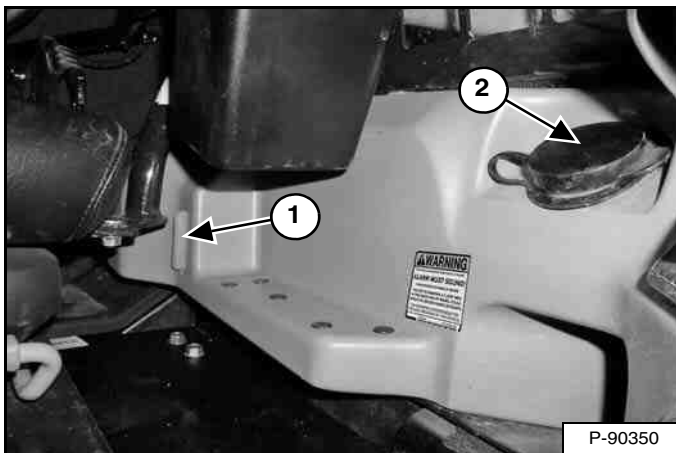

The washer fluid tank is located to the left of the operator seat. Check the fluid level in the sight gauge (Item 1). Remove the cap (Item 2) [Figure 34] to add washer fluid.

Cab Light

The cab light is located above the operator's left shoulder. More than one type can be found on this machine. The operation of each is explained below.

Figure 35

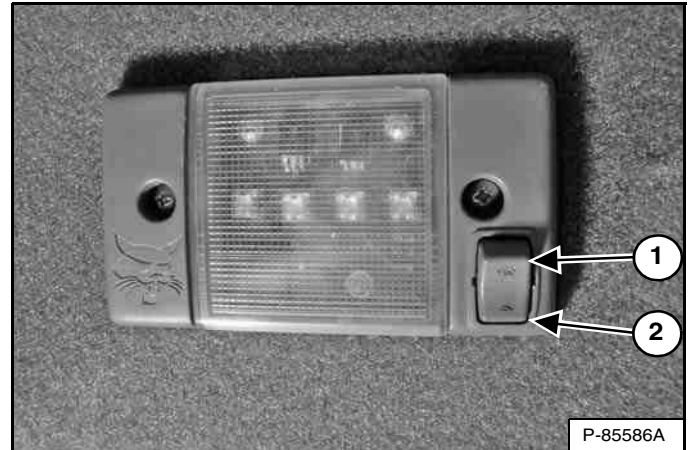

Push this side of the switch (Item 1) to turn the light ON. Push this side of the switch (Item 2) [Figure 35] to turn the light OFF.

Figure 36

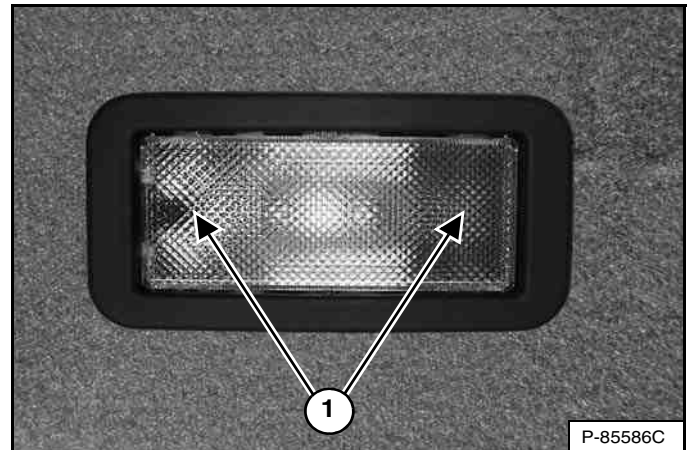

Push either side of the lens (Item 1) [Figure 36] to turn the light ON. Return the lens to the middle position to turn the light OFF.

BOBCAT INTERLOCK CONTROL SYSTEM (BICS™)

Description



AVOID INJURY OR DEATH

The Bobcat Interlock Control System (BICS™) must deactivate the lift, tilt and traction drive functions. If it does not, contact your dealer for service. **DO NOT** modify the system.

W-2151-1111

Figure 37

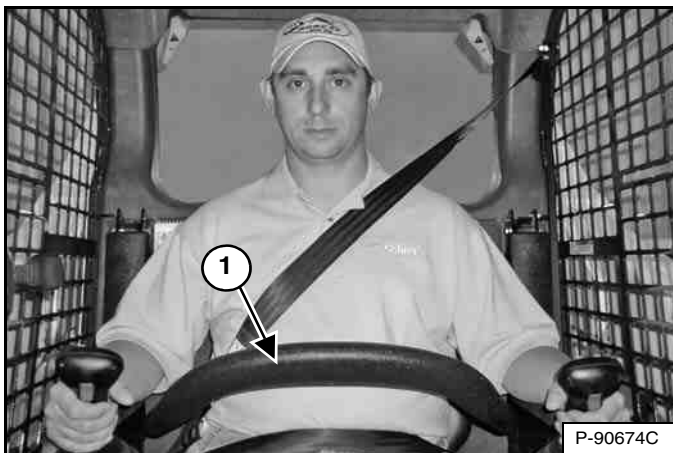

The Bobcat Interlock Control System (BICS™) has a pivoting seat bar with armrests (Item 1) [Figure 37]. The operator controls the use of the seat bar.



AVOID INJURY OR DEATH

When operating the machine:

- Keep the seat belt fastened snugly.
- The seat bar must be lowered.
- Keep your feet on the pedal controls or footrests and hands on the controls.

W-2261-0909

The BICS™ requires the operator to be seated in the operating position with the seat bar fully lowered before the lift, tilt, auxiliary hydraulics, and traction drive functions can be operated. The seat belt must be fastened anytime you operate the machine.

Operation

Figure 38



There are three display lights (Items 1, 2, and 3) [Figure 38] located on the left instrument panel that must be OFF to fully operate the machine.

When the seat bar is lowered, the engine is running, the PRESS TO OPERATE LOADER button is activated, and the parking brake is released; the lift, tilt, auxiliary hydraulics, and traction drive functions can be operated.

When the seat bar is raised; the lift, tilt, auxiliary hydraulics, and traction drive functions are deactivated.



AVOID INJURY OR DEATH

Before you leave the operator's seat:

- Lower the lift arms and put the attachment flat on the ground.
- Stop the engine.
- Engage the parking brake.
- Raise the seat bar.
- Move all controls to the NEUTRAL / LOCKED position to make sure the lift, tilt and traction drive functions are deactivated.

The seat bar system must deactivate these functions when the seat bar is up. See your Bobcat dealer for service if controls do not deactivate.

W-2463-1110

SEAT BAR RESTRAINT SYSTEM

Description

Figure 39

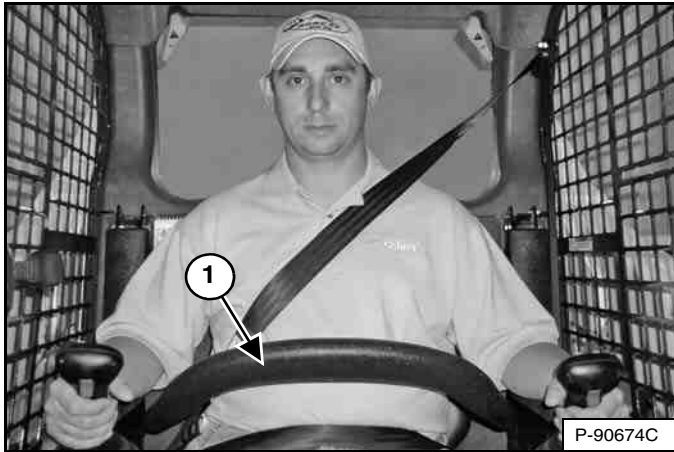

The seat bar restraint system has a pivoting seat bar with armrests (Item 1) [Figure 39].

The operator controls the use of the seat bar. The seat bar in the down position helps to keep the operator in the seat.

WARNING

AVOID INJURY OR DEATH

When operating the machine:

- Keep the seat belt fastened snugly.
- The seat bar must be lowered.
- Keep your feet on the pedal controls or footrests and hands on the controls.

W-2261-0909

Operation

When the seat bar is down, the engine is running, the PRESS TO OPERATE LOADER button is activated, and the brake is released; the lift, tilt, and traction drive functions can be operated.

When the seat bar is raised; the lift, tilt, and traction drive functions are deactivated and both foot pedals (if equipped) are locked when returned to NEUTRAL position.

WARNING

AVOID INJURY OR DEATH

Before you leave the operator's seat:

- Lower the lift arms and put the attachment flat on the ground.
- Stop the engine.
- Engage the parking brake.
- Raise the seat bar.
- Move all controls to the NEUTRAL / LOCKED position to make sure the lift, tilt and traction drive functions are deactivated.

The seat bar system must deactivate these functions when the seat bar is up. See your Bobcat dealer for service if controls do not deactivate.

W-2463-1110

PARKING BRAKE

Operation

Figure 40



Press the top of the switch (Item 1) [Figure 40] to engage the parking brake. The red light in the switch will turn on. The traction drive system is locked.

Move steering levers or joystick(s) slowly forward and backward. The TRACTION lock must be engaged. See your Bobcat dealer for service if loader fails to stop.

Press the bottom of the switch (Item 2) [Figure 40] to disengage the parking brake. The red light in the switch will turn off. The traction drive system is unlocked.

NOTE: The PARKING BRAKE light on the left instrument panel will remain ON until the engine is started, the PRESS TO OPERATE LOADER button is pressed, and the parking brake is disengaged.

TRACTION LOCK OVERRIDE

Description

Figure 41



(Functions Only When The Seat Bar Is Raised And The Engine Is Running) There is a TRACTION LOCK OVERRIDE button (Item 1) [Figure 41] on the left instrument panel that will allow you to use the steering controls to move the loader forward and backward when using the backhoe attachment.

Operation

Press the TRACTION LOCK OVERRIDE button once to unlock traction drive. The PARKING BRAKE light (Item 2) [Figure 41] is OFF.

Press the button a second time to lock the traction drive. The PARKING BRAKE light (Item 2) [Figure 41] is ON.

NOTE: The TRACTION LOCK OVERRIDE button will unlock the traction drive when the seat bar is raised and the engine is running.

NOTE: The TRACTION LOCK OVERRIDE button will function if the parking brake is in the engaged or disengaged position and the engine is running. If the Parking Brake switch is turned ON, the red light in the Parking Brake switch will turn OFF when TRACTION LOCK OVERRIDE is engaged.

ENGINE SPEED CONTROL

Operation

Figure 42

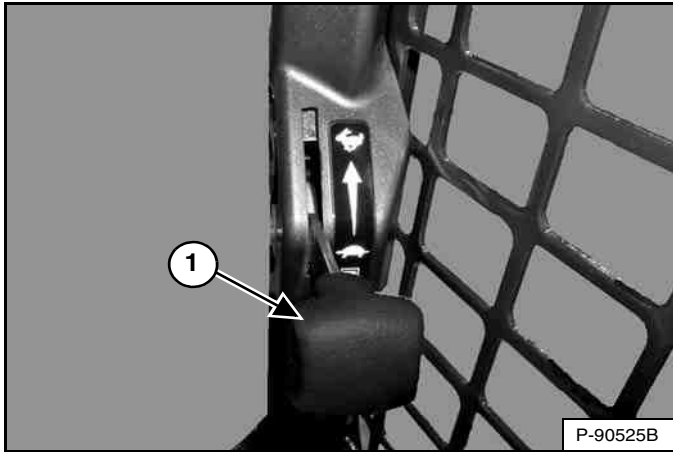

The engine speed control (Item 1) [Figure 42] is located alongside the door frame below the right panel.

Move the lever up to increase engine speed. Move down to decrease engine speed.

Figure 43

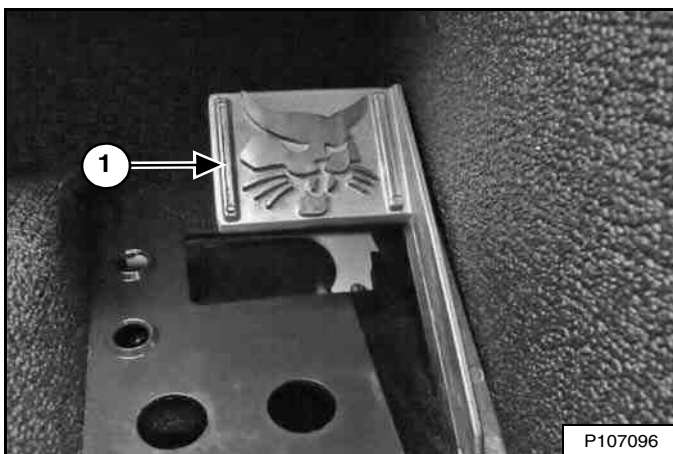

SJC equipped machines have a foot operated engine speed control pedal (Item 1) [Figure 43] in addition to the engine speed control lever. The pedal is located on the right side floor above the footrest.

LIFT ARM BYPASS CONTROL

Description

Figure 44

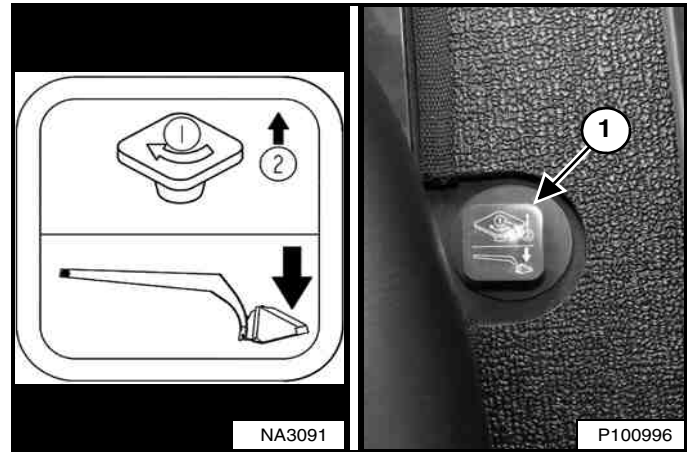

The lift arm bypass control (Item 1) [Figure 44], located to the right of the operator's seat, is used to lower the lift arms if the lift arms cannot be lowered during normal operations.

Operation

Perform the procedure below to operate the lift arm bypass control:

1. Sit in the operator's seat.
2. Fasten the seat belt and lower the seat bar.
3. Turn the knob (Item 1) [Figure 44] 90° clockwise.
4. Pull up and hold the knob until the lift arms lower.

EMERGENCY EXIT

The front opening on the operator cab and rear window provide exits.

Rear Window Identification

Figure 45

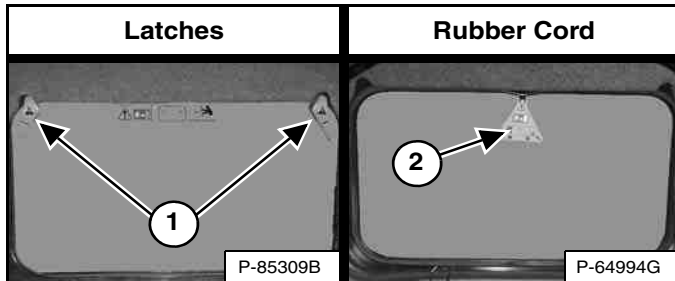

There are two different procedures for removing the rear window from your machine:

1. This window is equipped with latches [Figure 45].
2. This window is equipped with a rubber cord and tag [Figure 45].

NOTE: Use these procedures to remove the rear window only under emergency conditions. Damage to machine may occur.

Rear Window Removal (Latches)

Figure 46

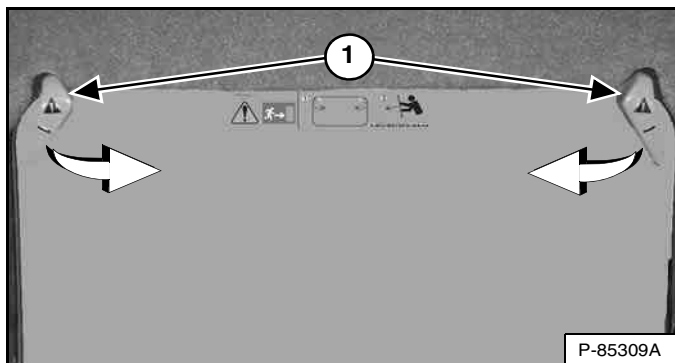

Turn both latches (Item 1) [Figure 46] in until they disengage from the window frame.

Push the rear window out of the rear of the operator cab.

Figure 47



Exit through the rear of the operator cab [Figure 47].

Rear Window Removal (Rubber Cord)

Figure 48



Pull on the tag on the top of the rear window to remove the rubber cord [Figure 48].

Push the rear window out of the rear of the operator cab.

Figure 49



Exit through the rear of the operator cab [Figure 49].

EMERGENCY EXIT (CONT'D)

External Access (Rear Window With Latches)

Figure 50

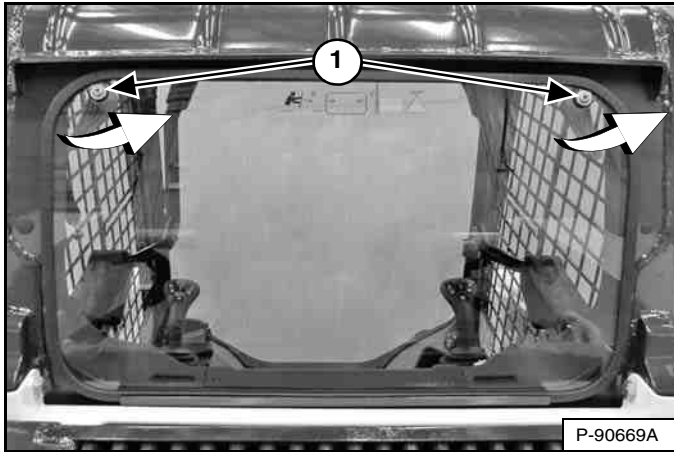

The rear window can be removed from outside the loader using a T40 TORX® Drive tool. Turn both screws (Item 1) [Figure 50] anticlockwise until the latches disengage from the window frame. Pull the top of the window away from the cab and lift up to remove.

OR

Figure 51

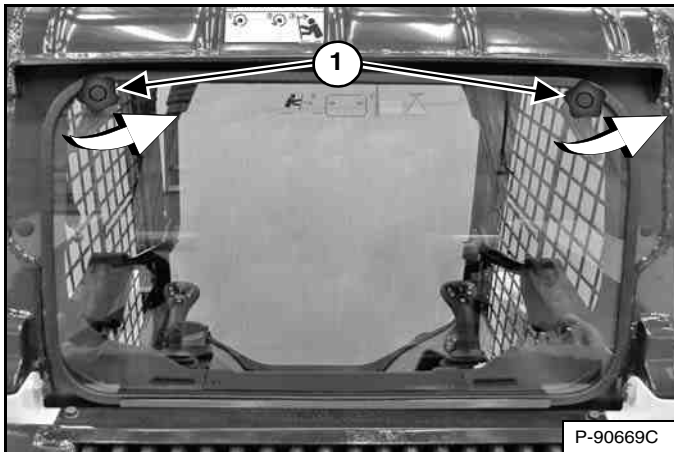

A kit is available to allow removal of the latch equipped rear window from outside the machine without tools. See your Bobcat dealer for availability.

Turn both knobs (Item 1) [Figure 51] anticlockwise until the latches disengage from the window frame. Pull the top of the window away from the cab and lift up to remove.

External Access (Rear Window With Rubber Cord)

A kit is available to allow removal of the rubber cord equipped rear window from outside the machine. See your Bobcat dealer for availability.

Figure 52

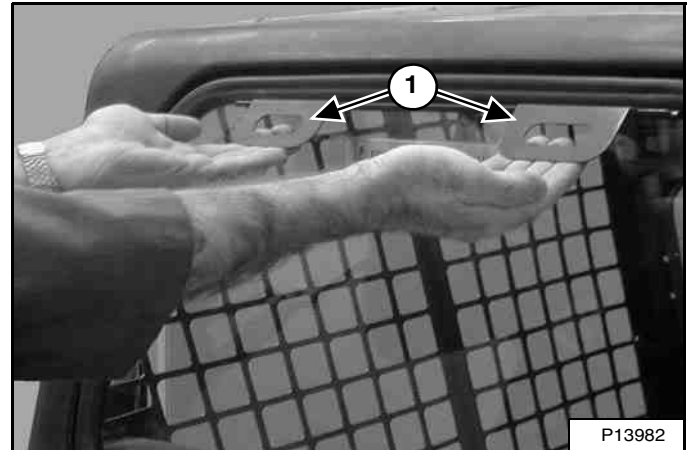

Pull both handles (Item 1) [Figure 52] up and out to remove the rear window.

Front Door

NOTE: Use this procedure to remove the front door only under emergency conditions. Damage to machine may occur.

Figure 53

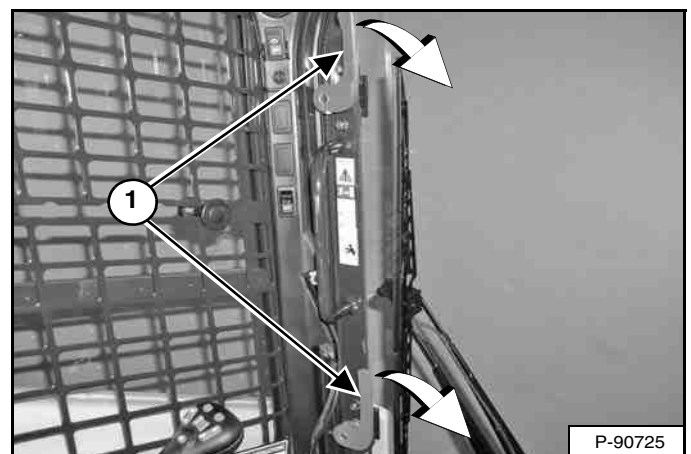

Turn both latches (Item 1) [Figure 53] down until they disengage from the door frame.

Push the door out of the operator cab door frame and exit through the opening.

EMERGENCY EXIT (CONT'D)

Front Door (Cont'd)

Front Door Reassembly

Reassemble the front door using the following instructions if the door was opened using the emergency exit procedure.

Figure 54

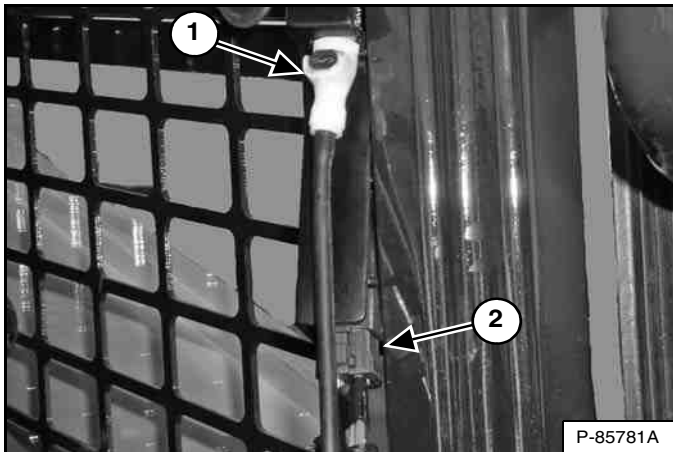

NOTE: Later models route the washer fluid hose differently and will not require this step.

Disconnect electrical connector (Item 2) and washer fluid hose (Item 1) (if equipped) [Figure 54].

Figure 55

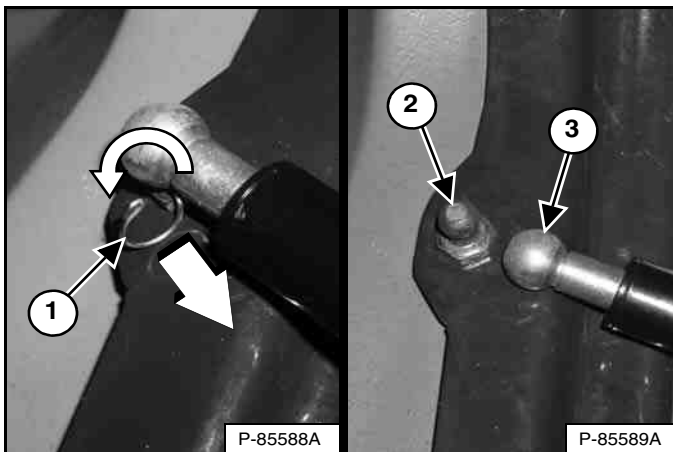

Rotate and pull the clip (Item 1) out of the gas spring socket. Pull the gas spring socket (Item 3) straight off the ball stud fitting (Item 2) [Figure 55].

Remove the door hinges from the loader.

Figure 56

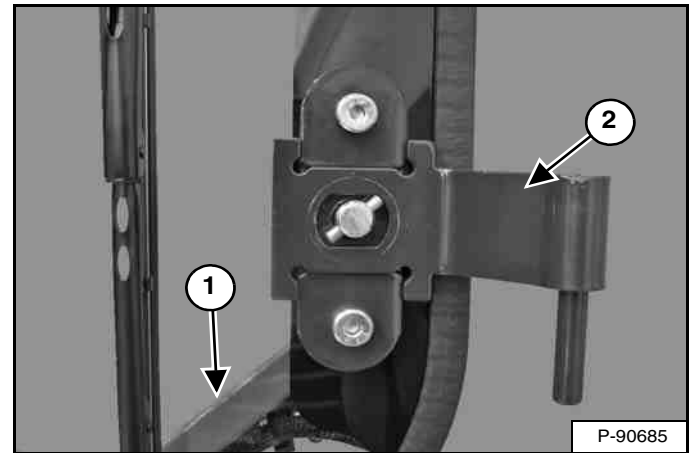

Orient the latches as shown (Item 1) and install the door hinges (Item 2) [Figure 56] on the door. (Bottom hinge shown.)

Figure 57

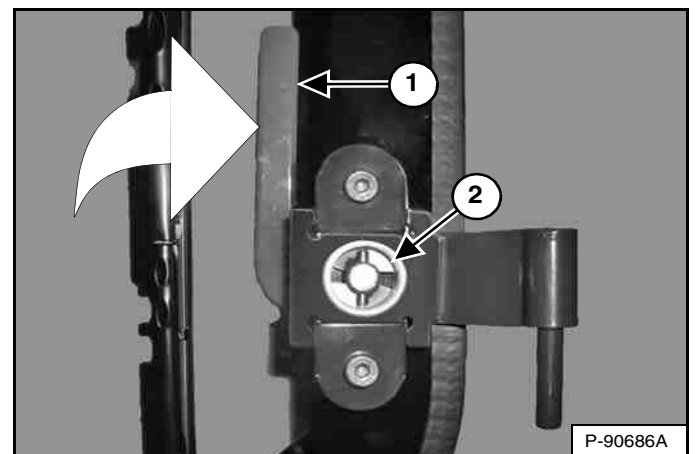

Install cast washers (Item 2) on door hinges taking care to match rectangular surfaces. Hold cast washer firmly against door and rotate latch (Item 1) [Figure 57] up to lock cast washer into position. (Bottom hinge shown.) (Plastic cap shown removed for visual clarity.)

Install door on loader.

Install the gas spring socket on the ball stud fitting. Install the clip into the hole in the gas spring socket. Rotate the clip to lock into position [Figure 55].

Connect electrical connector and washer fluid hose (if equipped) [Figure 54].

BACK-UP ALARM SYSTEM

This machine may be equipped with a Back-up Alarm.

Description

Figure 58

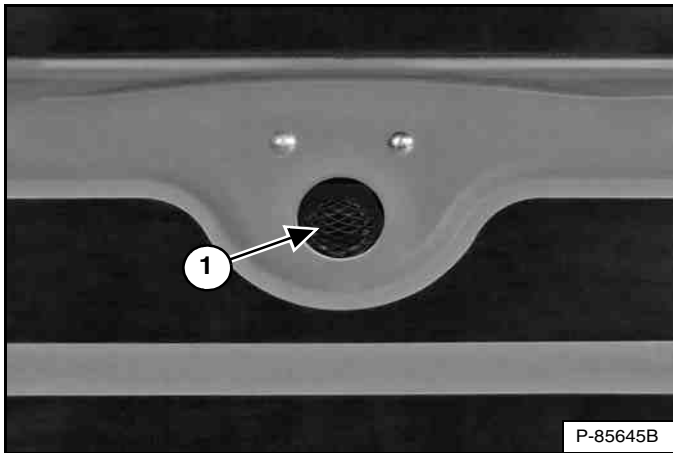

The back-up alarm (Item 1) [Figure 58] is located on the inside of the rear door.

A back-up alarm is not a substitute for looking to the rear when operating the loader in reverse, or for keeping bystanders away from the work area. Operators **must always** look in the direction of travel, including **reverse**, and must also keep bystanders away from the work area, even though the loader is equipped with a back-up alarm.

Operators must be trained to **always** look in the direction of travel, **including when operating the loader in reverse** and to keep bystanders away from the work area. Other workers should be trained to **always** keep away from the operator's work area and travel path.

Operation

WARNING

AVOID INJURY OR DEATH

- Always keep bystanders away from the work area and travel path.
- The operator must maintain a clear view of the direction of travel and look before and during machine movement.
- The back-up alarm must sound when operating the machine in the reverse direction.

W-2783-0118

The back-up alarm will sound when the operator moves both steering levers or joystick(s) into the reverse position. Slight movement of the steering levers into the reverse position is required with hydrostatic transmissions, before the back-up alarm will sound.

If alarm does not sound or for adjustment instructions, see inspection and maintenance instructions for the back-up alarm system in the preventive maintenance section of this manual. (See BACK-UP ALARM SYSTEM on Page 132.)

DRIVING AND STEERING THE LOADER

Available Control Configurations

This loader has four control configurations available:

- *Standard Controls* - Two steering levers control drive and steering functions.
- *Advanced Control System (ACS) (Option)* - Two steering levers control drive and steering functions.
- *Advanced Hand Controls (AHC) (Option)* - Two steering levers control drive and steering functions.
- *Selectable Joystick Controls (SJC) (Option)* -
 ('ISO' Pattern) - Left joystick controls the drive and steering functions.
 ('H' Pattern) - Left and right joysticks control left and right side drive and steering functions.

Operation (Standard, ACS, And AHC)

! WARNING

AVOID INJURY OR DEATH

When operating the machine:

- **Keep the seat belt fastened snugly.**
- **The seat bar must be lowered.**
- **Keep your feet on the pedal controls or footrests and hands on the controls.**

W-2261-0909

Figure 59



The steering levers (Item 1) [Figure 59] are on the left and right side in front of the seat.

Move the levers smoothly. Avoid sudden starting and stopping.

Figure 60

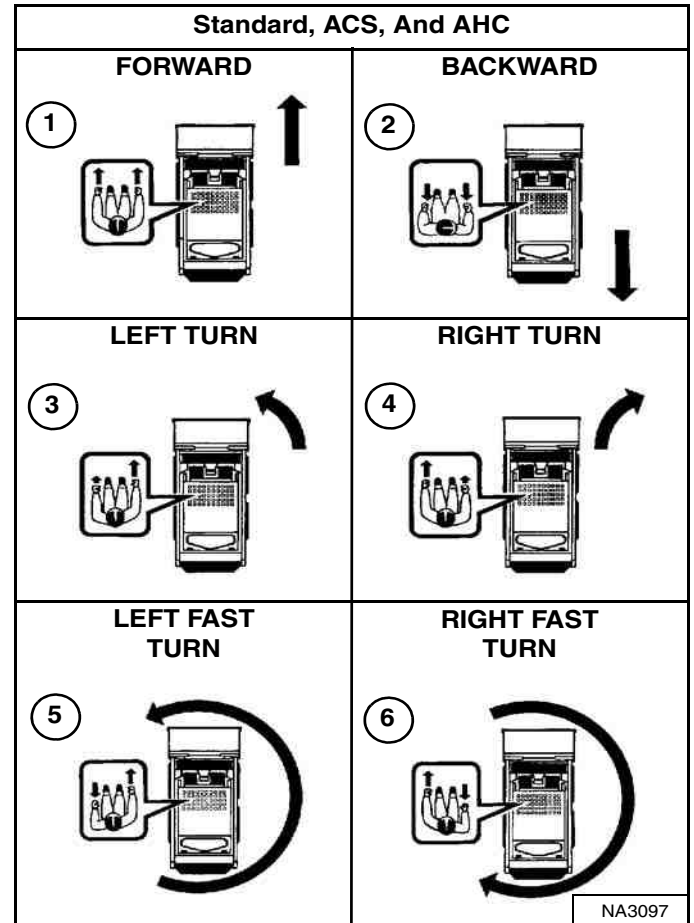

Steering Lever Functions (Drive And Steering) [Figure 60]:

1. **Forward Travel** - Push both levers forward.
2. **Backward Travel** - Pull both levers backward.
3. **Left Turn** - Move the right lever farther forward than the left lever.
4. **Right Turn** - Move the left lever farther forward than the right lever.
5. **Left Fast Turn** - Move the left lever backward and the right lever forward.
6. **Right Fast Turn** - Move the right lever backward and the left lever forward.

DRIVING AND STEERING THE LOADER (CONT'D)

Operation (SJC) In 'ISO' Control Pattern

Figure 61

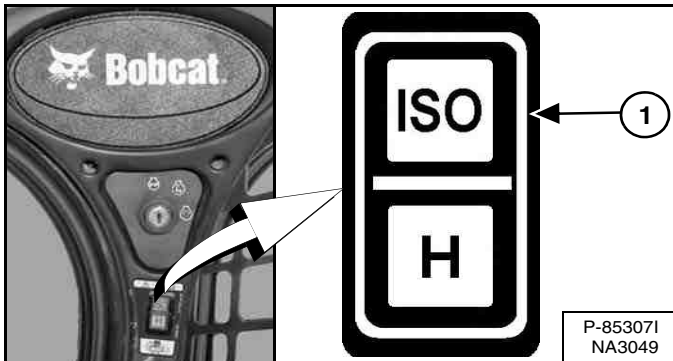

Select the 'ISO' control pattern by pressing the top of the switch (Item 1) [Figure 61].



AVOID INJURY OR DEATH

When operating the machine:

- Keep the seat belt fastened snugly.
- The seat bar must be lowered.
- Keep your feet on the foot rests and hands on control levers.

W-2399-0501

Figure 62



The joystick that controls drive and steering is on the left side in front of the seat (Item 1) [Figure 62].

Move the joystick smoothly. Avoid sudden starting and stopping.

Figure 63

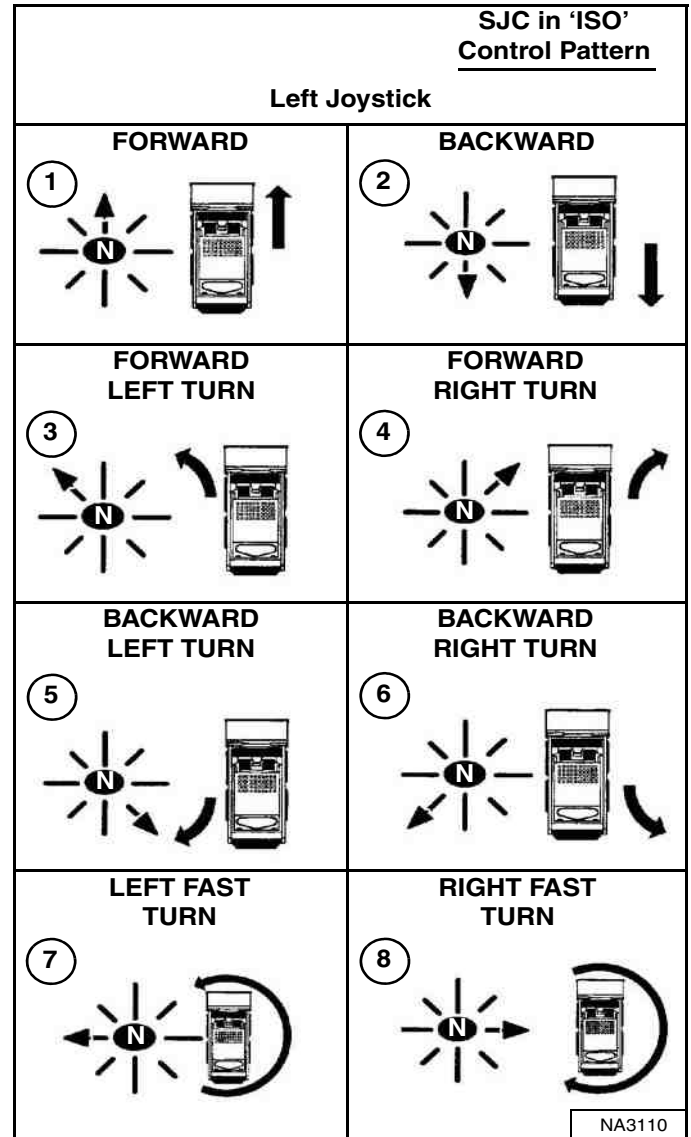

Left Joystick Functions (Drive And Steering) [Figure 63]:

1. **Forward Travel** - Move joystick forward.
2. **Backward Travel** - Move joystick backward.
3. **Forward Left Turn** - Move joystick forward and to the left.
4. **Forward Right Turn** - Move joystick forward and to the right.
5. **Backward Left Turn** - Move joystick backward and to the right.
6. **Backward Right Turn** - Move joystick backward and to the left.
7. **Left Fast Turn** - Move joystick to the left.
8. **Right Fast Turn** - Move joystick to the right.

DRIVING AND STEERING THE LOADER (CONT'D)

Operation (SJC) In 'H' Control Pattern

Figure 64

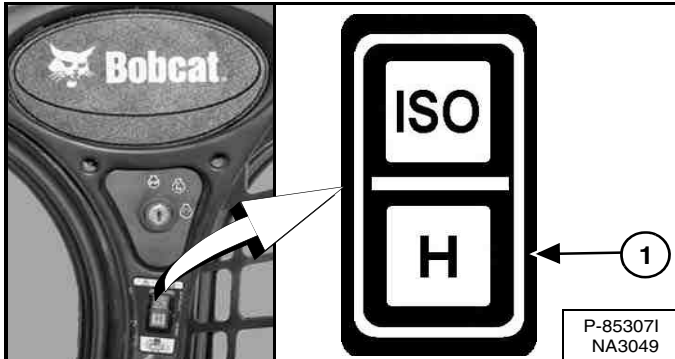

Select the 'H' control pattern by pressing the bottom of the switch (Item 1) [Figure 64].



AVOID INJURY OR DEATH

When operating the machine:

- Keep the seat belt fastened snugly.
- The seat bar must be lowered.
- Keep your feet on the foot rests and hands on control levers.

W-2399-0501

Figure 65

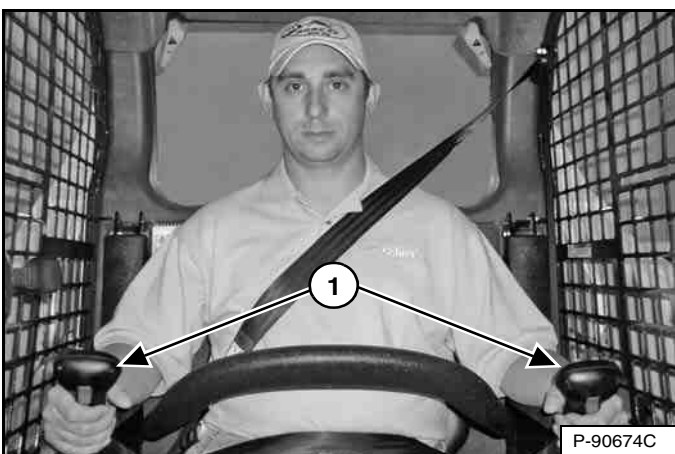

Both joysticks control drive and steering and are located on the left and right side in front of the seat (Item 1) [Figure 65].

Move the joysticks smoothly. Avoid sudden starting and stopping.

Figure 66

Left Joystick	Right Joystick	SJC in 'H' Control Pattern	
1			FORWARD
2			BACKWARD
3			LEFT TURN
4			RIGHT TURN
5			LEFT FAST TURN
6			RIGHT FAST TURN

NA3111

Joystick Functions (Drive And Steering) [Figure 66]:

1. **Forward Travel** - Move both joysticks forward.
2. **Backward Travel** - Move both joysticks backward.
3. **Forward Left Turn** - Move the right joystick farther forward than the left joystick.
4. **Forward Right Turn** - Move the left joystick farther forward than the right joystick.
5. **Left Fast Turn** - Move the left joystick backward and the right joystick forward.
6. **Right Fast Turn** - Move the left joystick forward and the right joystick backward.

STOPPING THE LOADER

Using The Control Levers Or Joysticks

When the steering levers or joysticks are moved to the NEUTRAL position, the hydrostatic transmission will act as a *service brake* to stop the loader.

TWO-SPEED CONTROL

Description

This machine may be equipped with two speed ranges, high and low. High range allows you to reduce cycle times when there is a long travel distance between the dig site and the dump site. You can also use the high range when travelling from one jobsite to another at faster speeds.

WARNING

HITTING OBSTRUCTIONS AT HIGH RANGE SPEEDS CAN CAUSE SERIOUS INJURY OR DEATH
Fasten shoulder belt for additional restraint when operating at high range speeds.

W-2754-0908

Figure 67

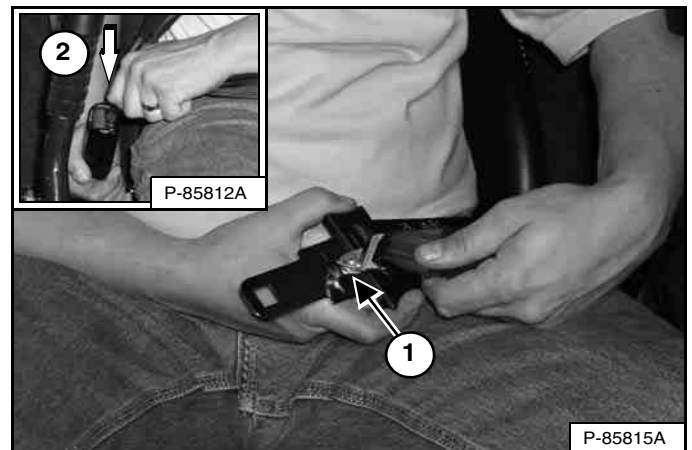

NOTE: The 3-point restraint must be used when selecting high range operation [Figure 67].

Connect the shoulder belt to the lap belt (Item 1). Pull the lap belt across to the right side of the seat and fasten (Item 2) [Figure 67].

The shoulder belt must be positioned over your left shoulder and lap belt over your lower hips.

Continue with the correct procedure for your machine. (See Operation (Standard, ACS, And AHC) on Page 69.) or (See Operation (SJC) on Page 69.)

TWO-SPEED CONTROL (CONT'D)

Operation (Standard, ACS, And AHC)

WARNING

HITTING OBSTRUCTIONS AT HIGH RANGE SPEEDS
CAN CAUSE SERIOUS INJURY OR DEATH

Fasten shoulder belt for additional restraint when operating at high range speeds.

W-2754-0908

Figure 68

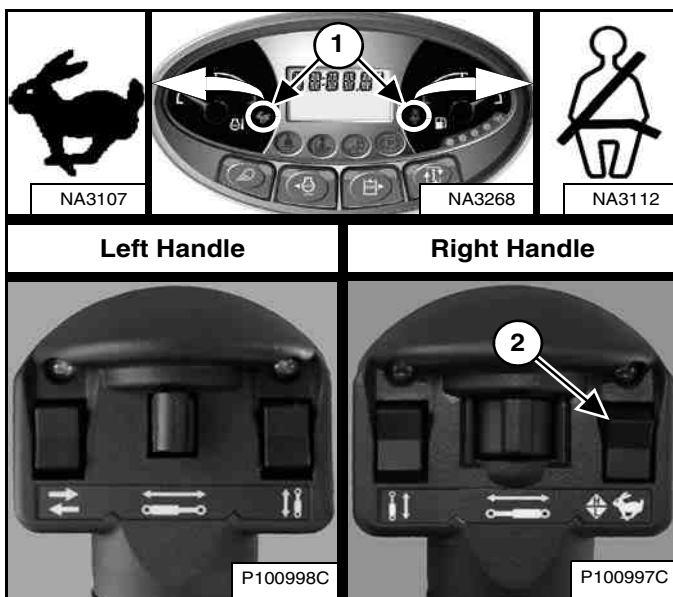

Press the top of the switch (Item 2) on the right handle for high range. The two-speed and shoulder belt icons located on the left instrument panel (Item 1) [Figure 68] will come on.

NOTE: This toggle switch retains the selected range. The loader is in high range speed at startup if the switch is in the high range position.

Press the bottom of the switch for low range.

Operation (SJC)

WARNING

HITTING OBSTRUCTIONS AT HIGH RANGE SPEEDS
CAN CAUSE SERIOUS INJURY OR DEATH

Fasten shoulder belt for additional restraint when operating at high range speeds.

W-2754-0908

Figure 69

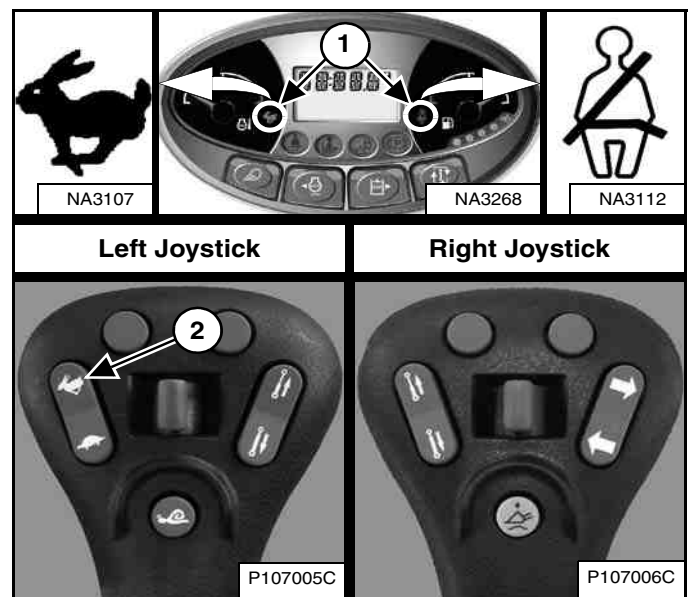

NOTE: You must disengage Speed Management before you can select high range.

Press the top of the switch (Item 2) on the left joystick for high range. The two-speed and shoulder belt icons located on the left instrument panel (Item 1) [Figure 69] will come on.

Press the bottom of the switch for low range.

SPEED MANAGEMENT

Speed Management is available on SJC equipped machines.

Description

Speed Management allows the loader to be manoeuvred at a slower travel speed, even during maximum movement of the joystick(s).

This feature can be useful when installing attachments, loading or unloading, and certain applications. (EXAMPLES: Landscaping, tilling, trenching)

Operation

NOTE: Two-Speed Loaders Only - You must be in low range speed to engage Speed Management.

NOTE: The factory default setting can be changed by the operator. (See Changing The Factory Default Setting on Page 71.)

Figure 70

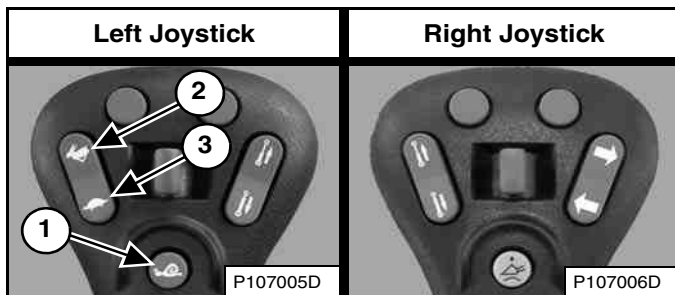

While Speed Management is engaged, press the top of the Speed Control switch (Item 2) [Figure 70] to increase the speed up to 99% [SPD 99] or the bottom of the switch (Item 3) [Figure 70] to decrease the speed down to 1% [SPD 01]. The percentages will appear in the display (Items 2, 3, and 4) [Figure 71].

Press button (Item 1) [Figure 70] again to disengage Speed Management and return to Standard Travel Speed. [STD] (Item 5) [Figure 71] will appear in the display.

Press the button (Item 1) [Figure 70] on the left joystick once to engage Speed Management.

The system will retain the speed percentage as long as the loader remains ON.

Figure 71

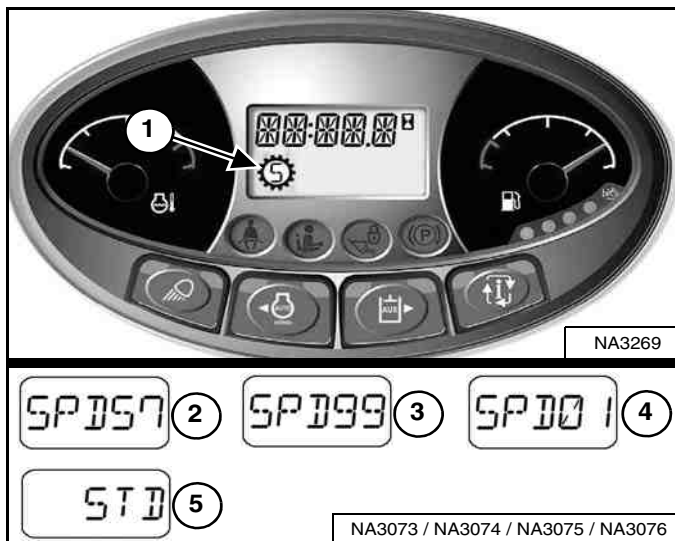

EXAMPLE: You can be using the machine at 40%, then disengage Speed Management to reposition the loader, and then reengage Speed Management. The speed percentage will still be at 40%.

EXAMPLE: Turning the key switch to STOP will return the Speed Management setting to default. The next time you start the engine and engage Speed Management, the speed is set at 57% (factory default setting) or the last default setting saved by the operator. (See Changing The Factory Default Setting on Page 71.)

NOTE: Two-Speed Loaders Only - You must disengage Speed Management before you can select high range.

The Speed Management icon (Item 1) [Figure 71] will appear in the display and remain on until the Speed Management button is pressed again or the machine is turned off.

When Speed Management is engaged, the machine will travel at the factory default setting of 57% of Standard Travel Speed and the percentage [SPD 57] will appear in the display (Item 2) [Figure 71].

SPEED MANAGEMENT (CONT'D)

Changing The Factory Default Setting

The Speed Management factory default setting can be changed by the operator to save adjustment time.

EXAMPLE: Your machine is often used for trenching and you prefer a Speed Management setting of 28% of Standard Travel Speed for that application. The Speed Management default setting can be changed to 28% of Standard Travel Speed instead of the factory default setting of 57%. Each time you start the machine and first select Speed Management, the machine will default to 28% of Standard Travel Speed.

Engage Speed Management. (See Description on Page 70.)

Figure 72

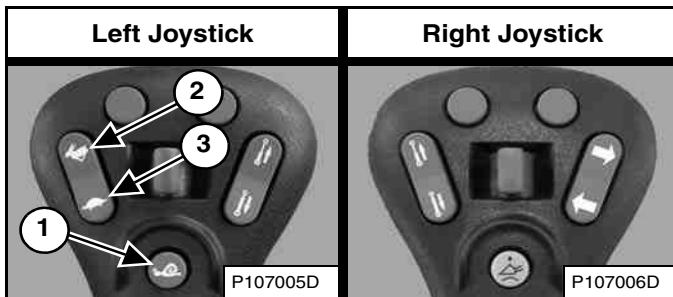

Adjust the speed percentage higher (Item 2) or lower (Item 3) [Figure 72] by pressing the Speed Control switch until the desired default setting is displayed.

Press and hold the button (Item 1) [Figure 72] on the left joystick to save the default setting.

Figure 73



The alarm will beep once, display [SET ##] [Figure 73] (## will indicate the percentage you selected) and remain in Speed Management mode.

Pressing the button (Item 1) [Figure 72] on the left joystick or turning the machine off will disengage Speed Management and return the loader to Standard Travel Speed.

When Speed Management is first selected each time the machine is started, the percentage you selected is the default setting. Speed Management can still be adjusted from 1% to 99% of Standard Travel Speed.

The default setting can be changed any time the operator chooses.



DRIVE RESPONSE

Drive Response is available on SJC equipped machines.

Description

Drive Response changes how responsive (more or less) the loaders drive and steering systems are when the operator moves the joystick(s).

Drive Response can be changed by the operator for different drive response preferences, various job conditions, and attachment use.

NOTE: Changes to drive response do not affect braking or stopping the loader.

There are three drive response settings:

- **[DR-1]** provides a smooth responsive reaction to joystick movement. (Drive only)
- **[DR-2]** is the default setting and provides a normal responsive reaction to joystick movement. (Drive only)
- **[DR-3]** provides a quick responsive reaction to joystick movement. (Drive only)

Operation

Perform PRE-STARTING PROCEDURE and STARTING THE ENGINE procedures:

1. Fasten seat belt.
2. Lower seat bar.
3. Put joysticks in NEUTRAL position.
4. Start the engine.
5. Press the PRESS TO OPERATE LOADER button.
6. Current drive response setting is displayed briefly in the data display.

DRIVE RESPONSE (CONT'D)

Operation (Cont'd)

Figure 74

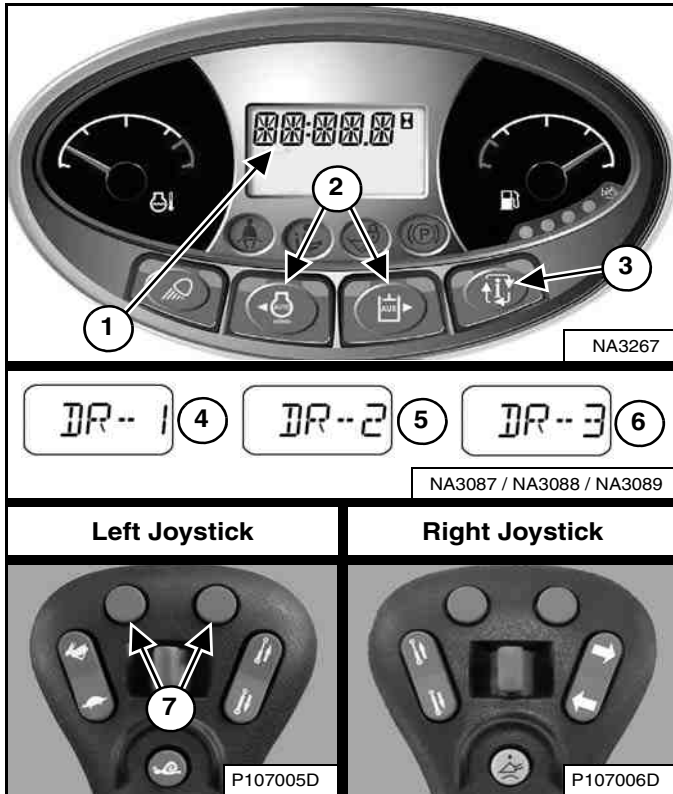

Press the Information button (Item 3) to cycle the data display until the drive response menu is displayed. The current drive response setting will appear in the data display (Item 1) [Figure 74].

Press the left or right scroll button (Item 2) [Figure 74] on the left panel to adjust the setting. Adjustments to the drive response are effective immediately.

OR

Press the left or right button (Item 7) [Figure 74] on the left joystick to adjust the setting. Adjustments to the drive response are effective immediately.

Press the left scroll button on the left panel or the left button on the left joystick to scroll down through the three drive response settings (Items 4, 5, and 6). Press the right scroll button on the left panel or the right button of the left joystick to scroll up through the three drive response settings (Items 4, 5, and 6) [Figure 74].

Saving The Drive Response Setting:

The current drive response setting can be saved by pressing the Information button (Item 3) [Figure 74] to exit from the drive response adjustment menu.

OR

If no buttons are pressed for 10 seconds, the drive response setting will be saved and the display screen will change to the hourmeter.

NOTE: Machines equipped with a Deluxe Instrumentation Panel will save the drive response setting for each user. Example: If user 1 saves the setting [DR-2], the machine will be in [DR-2] the next time user 1 password is entered.

STEERING DRIFT COMPENSATION

Steering Drift Compensation is available on SJC equipped machines.

Description

Steering Drift Compensation can be used to reduce steering drift to maintain a desired travel path in forward and reverse directions.

Examples of applications where this feature can be used:

- To compensate for normal variations such as tyre inflation pressure, track tension, tyre wear, and track wear.
- Using side shift attachments such as trenchers, planers, and silt fence installers.
- Driving on uneven terrain such as crowned road surfaces.

Operation

Perform PRE-STARTING PROCEDURE and STARTING THE ENGINE procedures:

1. Fasten seat belt.
2. Lower seat bar.
3. Put joysticks in NEUTRAL position.
4. Start the engine.
5. Press the PRESS TO OPERATE LOADER button.
6. Current drive response setting is displayed briefly in the data display.

Figure 75

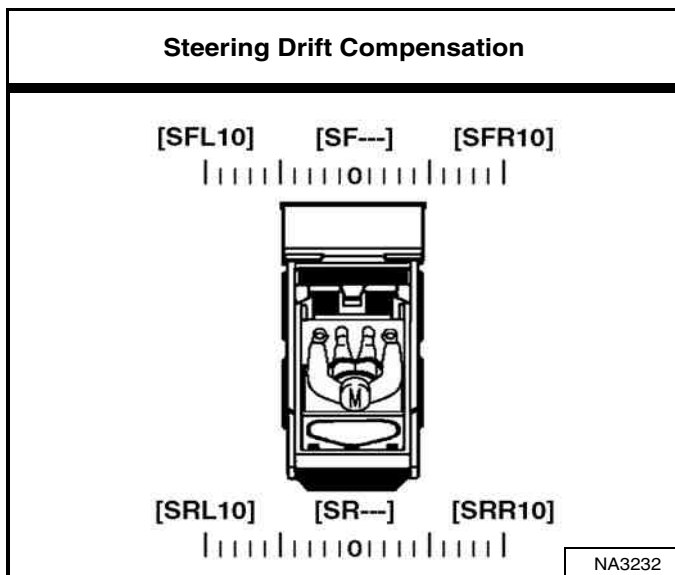

Steering drift compensation contains a total of 21 settings. Steering drift compensation can be set to any point from NEUTRAL to [SFL10] or [SRL10] left, and from NEUTRAL to [SFR10] or [SRR10] right. [SF---] or [SR---] is displayed when set for NEUTRAL [Figure 75].

STEERING DRIFT COMPENSATION (CONT'D)

Operation (Cont'd)

Figure 76

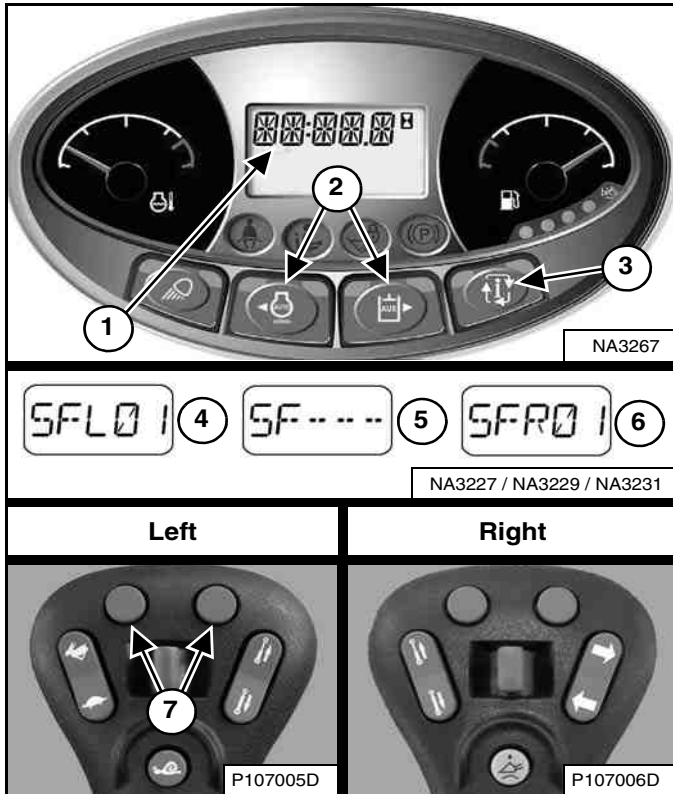

Press the right scroll button on the left panel or the right button on the left control to adjust the machine back toward centre. The display will decrease down to NEUTRAL displayed as [SF---] (Item 5). Another press of the upper right button will cause [SFR01] (Item 6) to appear in the data display (Item 1) [Figure 76]. The number will increase by one each time you press the button up to a maximum of [SFR10]. The higher the number, the greater the amount of steering drift compensation to the right.

Forward steering drift compensation setting can be adjusted with the steering controls in NEUTRAL or during forward travel. Reverse steering drift compensation setting can be adjusted during reverse travel. The letter [R] will appear in place of the letter [F] in the data display when setting reverse steering drift compensation. (EXAMPLES: [SRL01], [SRR01], and [SR---]).

Exiting The Steering Drift Compensation Menu:

Press the Information button (Item 3) [Figure 76] to exit from the steering drift compensation adjustment menu.

OR

If no buttons are pressed for 10 seconds, the display screen will change to the hourmeter.

Press the Information button (Item 3) to cycle the data display until the steering drift compensation menu is displayed. The current steering drift compensation setting will appear in the data display (Item 1) [Figure 76].

Press the left or right scroll button (Item 2) [Figure 76] on the left panel to adjust the setting. Adjustments to steering drift compensation are effective immediately and saved automatically.

OR

Press the left or right button (Item 7) [Figure 76] on the left control to adjust the setting. Adjustments to the steering drift compensation are effective immediately and saved automatically.

Press the left scroll button on the left panel or the left button on the left control to adjust the machine left. [SFL01] (Item 4) through a maximum of [SFL10] will appear in the data display (Item 1) [Figure 76]. The number will increase by one each time you press the button. The higher the number, the greater the amount of steering drift compensation to the left.



LIFT AND TILT COMPENSATION

Lift and Tilt Compensation is available on ACS, AHC, and SJC equipped machines.

Description

Lift and Tilt Compensation can be used to adjust the lift and tilt control sensitivity. This enables the operator to increase or decrease the amount of control movement before lift up, lift down, tilt back, and tilt out begins. The operator can change each setting to their preference.

EXAMPLE: Your machine is being used with a mower attachment. The mower slowly lowers because you move the controls slightly when passing over extremely rough ground. Adjusting the lift down control to a low setting will provide an increased NEUTRAL band and allow for more control movement before the lift arms move.

The procedure that follows provides a starting point for the lift and tilt control compensation. Operators can adjust the settings to account for attachment weight, engine rpm and application.

Operation

NOTE: Lift and Tilt Compensation should be performed when the machine has been warmed to operating temperature and any attachment has been removed.

Perform PRE-STARTING PROCEDURE and STARTING THE ENGINE procedures:

1. Fasten seat belt.
2. Lower seat bar and engage the parking brake.
3. Put handles or joysticks in NEUTRAL position.
4. Start the engine.
5. **(ACS)** - Select hand control operation.

OR

(SJC) - Select 'H' control pattern.

6. Press the PRESS TO OPERATE LOADER button.
7. Raise the lift arms approximately 1 m (3 ft) off the ground and tilt the Bob-Tach frame forward approximately 300 mm (1 ft).
8. Raise and lower the seat bar to engage the interlocks and enable the procedure to be performed.
9. Increase engine speed to high idle.
10. Continue with the correct procedure for your machine. (See Operation (ACS And AHC) on Page 77.) or (See Operation (SJC) on Page 78.)

NOTE: When the procedure has begun, raising the seat bar will cause the machine to disengage from lift and tilt compensation. Changes made to the lift and tilt compensation settings will NOT be saved.

LIFT AND TILT COMPENSATION (CONT'D)

Operation (ACS And AHC)

This procedure is described using hand controls. The procedure can be performed using foot pedals on ACS equipped loaders.

Figure 77

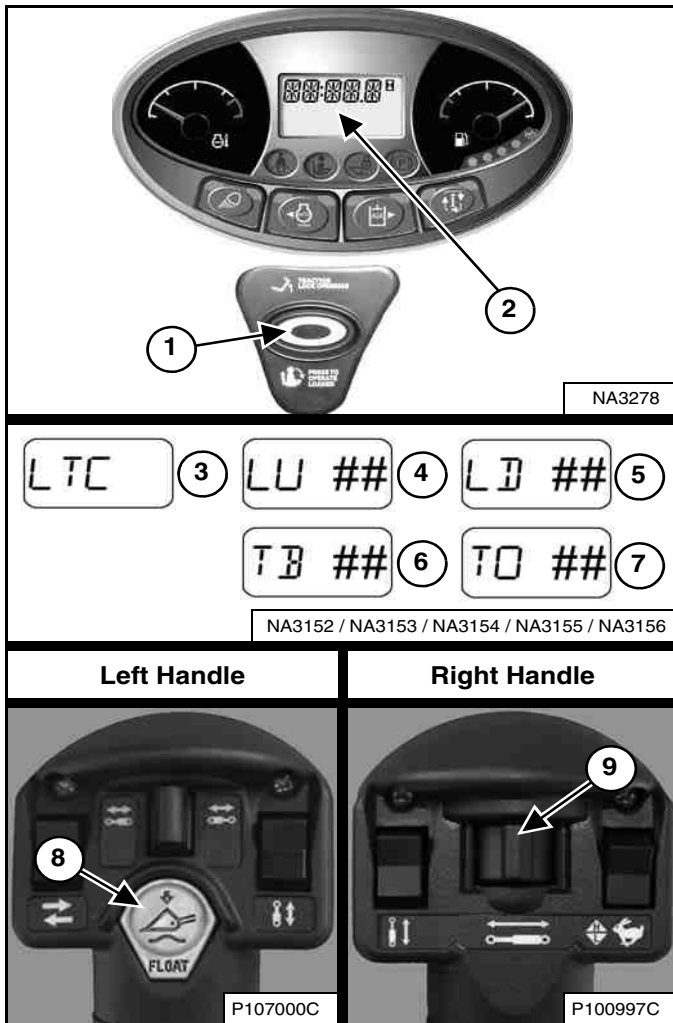

LTC - Lift and Tilt Compensation
 LU - Lift Up
 LD - Lift Down
 TB - Tilt Back
 TO - Tilt Out

1. Press and hold the float button (Item 8). Press the PRESS TO OPERATE LOADER button (Item 1). Release both buttons. This will open the lift and tilt compensation menu. [LTC] (Item 3) will appear in the data display (Item 2) [Figure 77].

2. Move the left handle outward and hold. [LU ##] (Item 4) will appear in the data display. (## will indicate the current setting.) Move the switch (Item 9) [Figure 77] to the right repeatedly until a slight upward movement of the lift arms is noticed. The setting will increase by one each time the switch is moved. The available range of adjustment is -25 to 35.

NOTE: If the lift arms begin to move immediately, move the switch (Item 9) [Figure 77] to the left repeatedly until lift arm movement stops, then move the switch to the right repeatedly until a slight upward movement of the lift arms is noticed. (This procedure also applies to the next three steps.)

3. Move the left handle inward and hold. [LD ##] (Item 5) will appear in the data display. Move the switch (Item 9) [Figure 77] to the right repeatedly until a slight downward movement of the lift arms is noticed.
4. Move the right handle inward and hold. [TB ##] (Item 6) will appear in the data display. Move the switch (Item 9) [Figure 77] to the right repeatedly until a slight backward tilt movement of the Bob-Tach frame is noticed.
5. Move the right handle outward and hold. [TO ##] (Item 7) will appear in the data display. Move the switch (Item 9) [Figure 77] to the right repeatedly until a slight forward tilt movement of the Bob-Tach frame is noticed.

Exiting The Lift And Tilt Compensation Menu:

The current lift and tilt compensation setting can be saved by pressing the PRESS TO OPERATE LOADER button (Item 1) [Figure 77]. The machine will exit from the lift and tilt compensation menu.

OR

Raise and lower the seat bar to exit from the lift and tilt compensation menu without saving. This will cancel all changes made. Press the PRESS TO OPERATE LOADER button (Item 1) [Figure 77] to continue machine operation.

Perform several lift and tilt functions to determine if the settings match your preferences. Repeat procedure if desired.

LIFT AND TILT COMPENSATION (CONT'D)

Operation (SJC)

This procedure is described using the 'H' control pattern. The procedure can be performed using the 'ISO' control pattern on SJC equipped loaders.

Figure 78

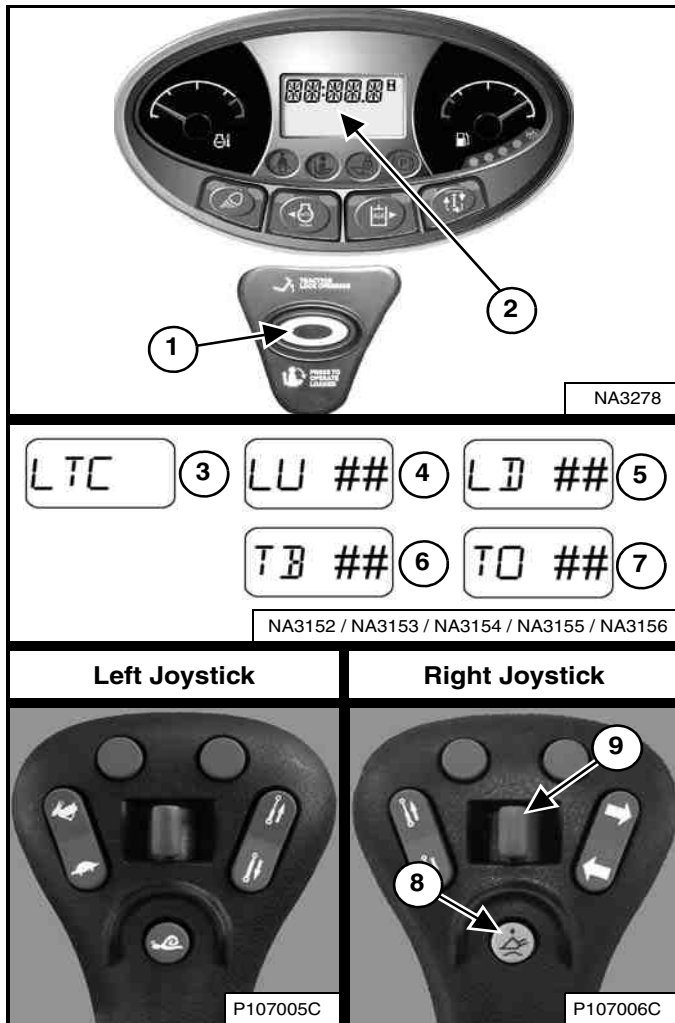

LTC - Lift and Tilt Compensation
 LU - Lift Up
 LD - Lift Down
 TB - Tilt Back
 TO - Tilt Out

1. Press and hold the float button (Item 8). Press the PRESS TO OPERATE LOADER button (Item 1). Release both buttons. This will open the lift and tilt compensation menu. [LTC] (Item 3) will appear in the data display (Item 2) [Figure 78].

2. Move the left joystick outward and hold. [LU ##] (Item 4) will appear in the data display. (## will indicate the current setting.) Move the switch (Item 9) [Figure 78] to the right repeatedly until a slight upward movement of the lift arms is noticed. The setting will increase by one each time the switch is moved. The available range of adjustment is -25 to 35.

NOTE: If the lift arms begin to move immediately, move the switch (Item 9) [Figure 78] to the left repeatedly until lift arm movement stops, then move the switch to the right repeatedly until a slight upward movement of the lift arms is noticed. (This procedure also applies to the next three steps.)

3. Move the left joystick inward and hold. [LD ##] (Item 5) will appear in the data display. Move the switch (Item 9) [Figure 78] to the right repeatedly until a slight downward movement of the lift arms is noticed.
4. Move the right joystick inward and hold. [TB ##] (Item 6) will appear in the data display. Move the switch (Item 9) [Figure 78] to the right repeatedly until a slight backward tilt movement of the Bob-Tach frame is noticed.
5. Move the right joystick outward and hold. [TO ##] (Item 7) will appear in the data display. Move the switch (Item 9) [Figure 78] to the right repeatedly until a slight forward tilt movement of the Bob-Tach frame is noticed.

Exiting The Lift And Tilt Compensation Menu:

The current lift and tilt compensation setting can be saved by pressing the PRESS TO OPERATE LOADER button (Item 1) [Figure 78]. The machine will exit from the lift and tilt compensation menu.

OR

Raise and lower the seat bar to exit from the lift and tilt compensation menu without saving. This will cancel all changes made. Press the PRESS TO OPERATE LOADER button (Item 1) [Figure 78] to continue machine operation.

Perform several lift and tilt functions to determine if the settings match your preferences. Repeat procedure if desired.

HYDRAULIC CONTROLS

Description

Two foot pedals (or optional hand controls or optional joysticks) control the hydraulic cylinders for the lift and tilt functions. Put your feet on the pedals (or footrests) and **KEEP THEM THERE** any time you operate the loader.

Standard Controls And Advanced Control System (ACS) In FOOT Pedal Mode

Figure 79

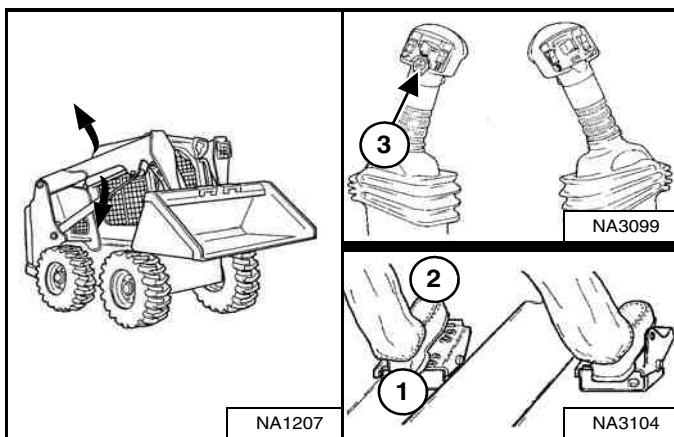

Lift Arm Float Position (With ACS) - (Left Pedal And Left Handle)

Press and hold the Float button (Item 3) while the left pedal is in NEUTRAL. Push the toe of the pedal forward to lift arm down position (Item 2) [Figure 79], then release the button.

Press Float button (Item 3) again or raise the lift arms (Item 1) [Figure 79] to disengage.

Use the float position of the lift arms to level loose material while driving backward.

Lift Arm Operation - (Left Pedal)

Push the heel (Item 1) [Figure 79] of the pedal to raise the lift arms.

Push the toe (Item 2) [Figure 79] of the pedal to lower the lift arms.

Lift Arm Float Position - (Left Pedal)

Push the toe of the pedal (Item 2) [Figure 79] all the way forward until the pedal locks into the float position.

Raise the lift arms (Item 1) [Figure 79] to disengage.

Use the float position of the lift arms to level loose material while driving backward.

Figure 80

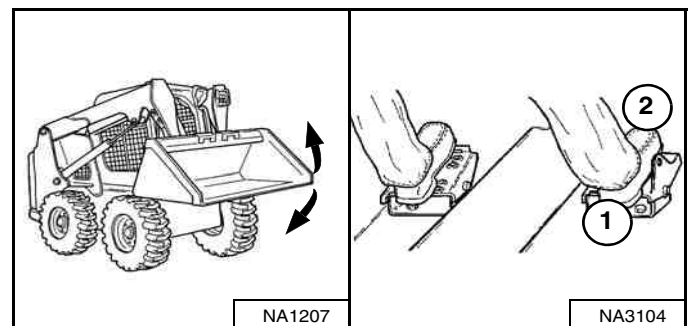

Tilt Operation - (Right Pedal)

Push the heel of the pedal (Item 1) [Figure 80] to tilt the bucket backward.

Push the toe of the pedal (Item 2) [Figure 80] to tilt the bucket forward.

HYDRAULIC CONTROLS (CONT'D)

Advanced Control System (ACS) In HAND Control Mode And Advanced Hand Controls (AHC)

Figure 81

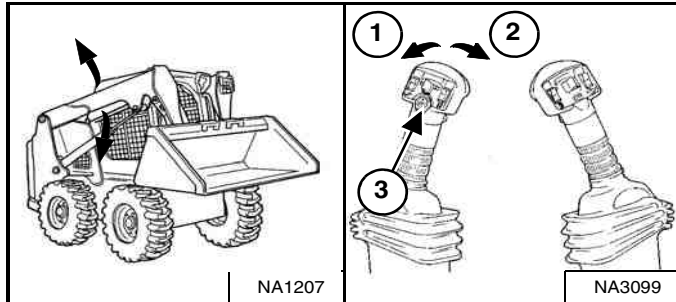

Lift Arm Operation - (Left Handle)

Move the handle outward (Item 1) [Figure 81] to raise the lift arms.

Move the handle inward (Item 2) [Figure 81] to lower the lift arms.

Lift Arm Float Position - (Left Handle)

Press and hold the Float button (Item 3) while the handle is in NEUTRAL. Move the handle to lift arm down position (Item 2) [Figure 81], then release the button.

Press Float button (Item 3) again or move the handle to lift arm up position (Item 1) [Figure 81] to disengage.

Use the float position of the lift arms to level loose material while driving backward.

Figure 82

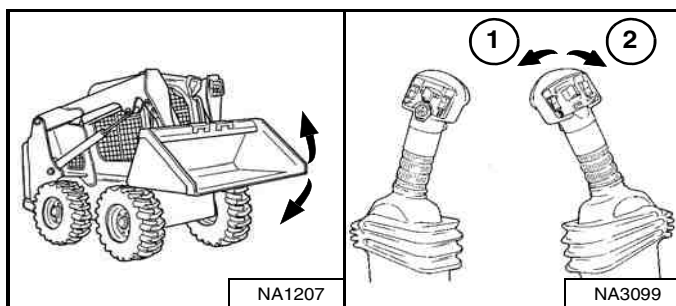

Tilt Operation - (Right Handle)

Move the handle inward (Item 1) [Figure 82] to tilt the bucket backward.

Move the handle outward (Item 2) [Figure 82] to tilt the bucket forward.

Selectable Joystick Controls (SJC) In 'ISO' Control Pattern

Figure 83

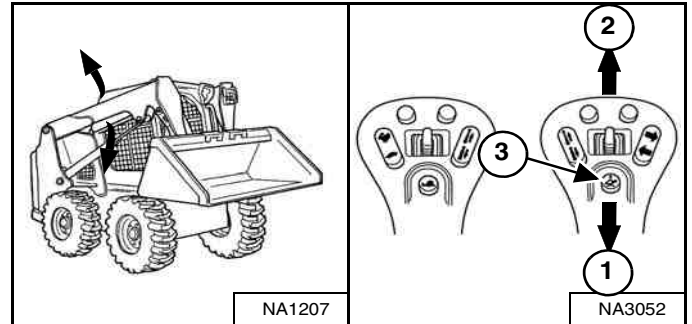

Lift Arm Operation - (Right Hand Joystick)

Move the joystick backward (Item 1) [Figure 83] to raise the lift arms.

Move the joystick forward (Item 2) [Figure 83] to lower the lift arms.

Lift Arm Float Position - (Right Hand Joystick)

Press and hold the Float button (Item 3) while the joystick is in NEUTRAL. Move the joystick to lift arm down position (Item 2) [Figure 83], then release the button.

Press Float button (Item 3) again or move the joystick to lift arm up position (Item 1) [Figure 83] to disengage.

Use the float position of the lift arms to level loose material while driving backward.

Figure 84

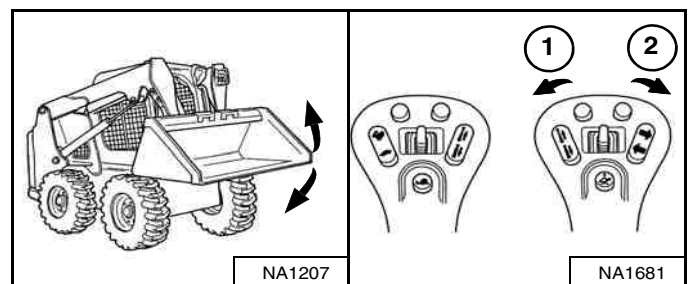

Tilt Operation - (Right Hand Joystick)

Move the joystick inward (Item 1) [Figure 84] to tilt the bucket backward.

Move the joystick outward (Item 2) [Figure 84] to tilt the bucket forward.

HYDRAULIC CONTROLS (CONT'D)

Selectable Joystick Controls (SJC) In 'H' Control Pattern

Figure 85

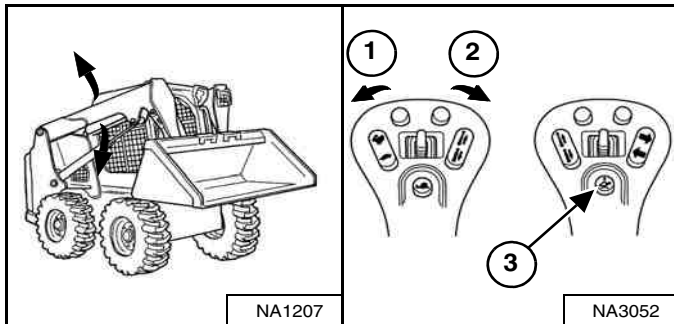

Lift Arm Operation - (Left Hand Joystick)

Move the joystick outward (Item 1) [Figure 85] to raise the lift arms.

Move the joystick inward (Item 2) [Figure 85] to lower the lift arms.

Lift Arm Float Position - (Left And Right Hand Joysticks)

Press and hold the Float button (Item 3) while the joysticks are in NEUTRAL. Move the left joystick to lift arm down position (Item 2) [Figure 85], then release the button.

Press Float button (Item 3) again or move the left joystick to lift arm up position (Item 1) [Figure 85] to disengage.

Use the float position of the lift arms to level loose material while driving backward.

Figure 86

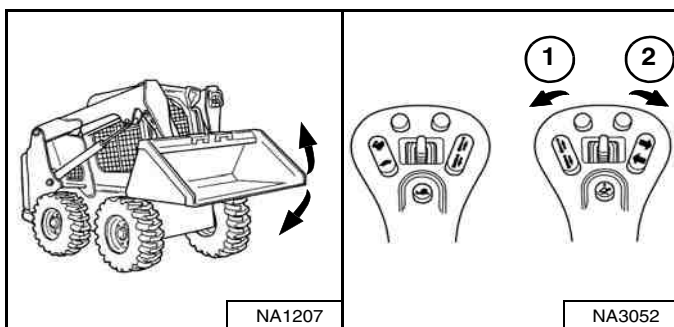

Tilt Operation - (Right Hand Joystick)

Move the joystick inward (Item 1) [Figure 86] to tilt the bucket backward.

Move the joystick outward (Item 2) [Figure 86] to tilt the bucket forward.

Hydraulic Bucket Positioning

The function of hydraulic bucket positioning is to keep the bucket at the same approximate angle as the lift arms are raised.

Figure 87

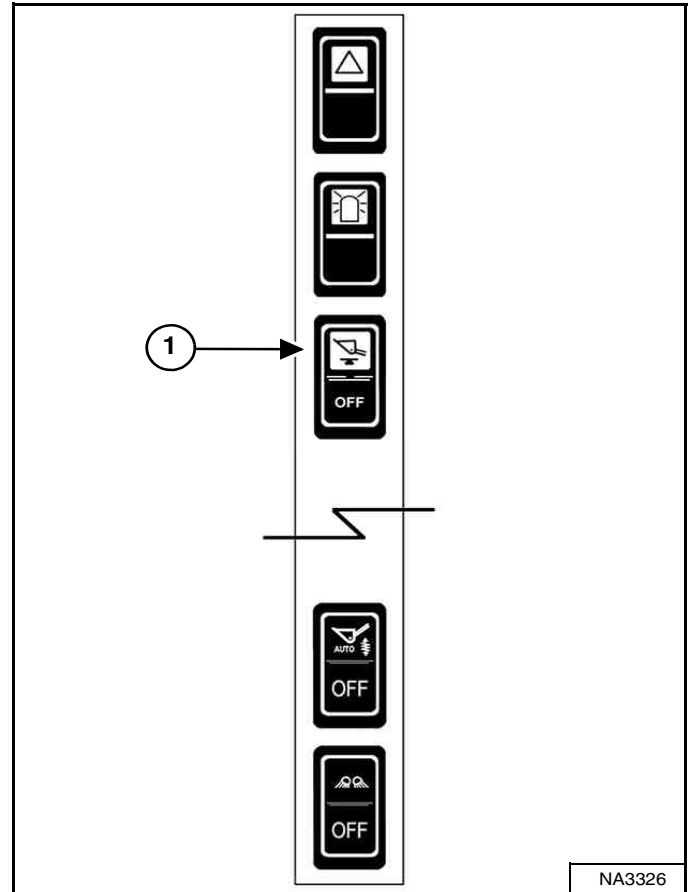

Press the top of the Bucket Positioning switch (Item 1) [Figure 87] on the left switch panel to engage the bucket positioning function. The amber light in the switch will turn on. Press the bottom of the switch to disengage. The amber light will turn off.

Bucket positioning functions only during upward lift cycle.

HYDRAULIC CONTROLS (CONT'D)

Automatic Ride Control

This machine may be equipped with Automatic Ride Control.

Automatic ride control provides a smoother ride, reduced load spillage, and improved machine control when traveling over uneven ground with heavy loads or in heavy digging applications.

Figure 88

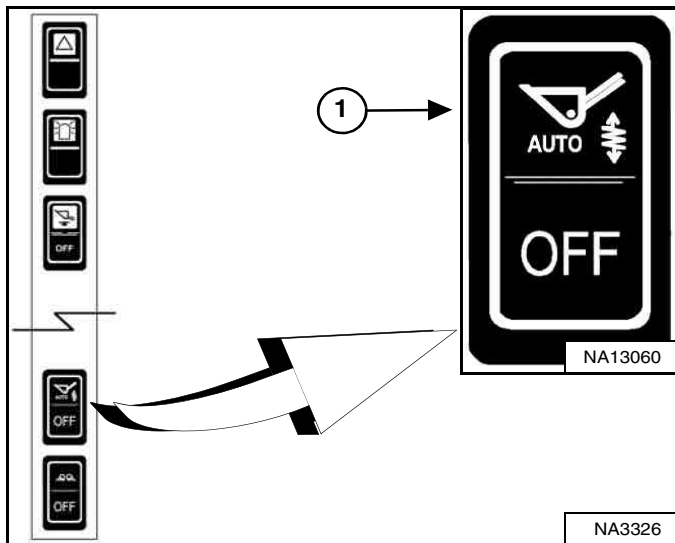

Press the top of the Automatic Ride Control switch (Item 1) [Figure 88] on the left switch panel to engage the automatic ride control function.

The loader software will engage and disengage ride control automatically based on lift arm load and operation.

The automatic ride control system uses an accumulator that requires occasional service. (See AUTOMATIC RIDE CONTROL ACCUMULATOR on Page 176.)

Press the bottom of the switch to disengage.

NOTE: Certain applications will not benefit from using automatic ride control. Turn OFF when using certain attachments for better performance.

WARNING

AVOID UNEXPECTED LIFT ARM MOVEMENT

Operating with the Automatic Ride Control switch in the AUTO position may result in the lift arms slowly raising during certain conditions when the operator moves the hydraulic controls in a specific manner:

1. A small or no load on the lift arms. **EXAMPLE:** Empty bucket or no attachment installed.

WITH

2. High hydraulic pressure in the tilt or auxiliary hydraulic system. **EXAMPLE:** Holding the tilt control forward or backward after it stops moving OR when an attachment hydraulic motor is stalled.

AND

3. While moving the lift control to raise or lower the lift arms.

NOTE: The slow upward movement of the lift arms will continue briefly even after the operator moves the hydraulic controls back to NEUTRAL under the conditions and operation described above.

Disengage the automatic ride control functions for applications where precise lift arm control is required or whenever unexpected lift arm movement is not desired.

W-3017-0816

HYDRAULIC CONTROLS (CONT'D)

Reversing Fan

This machine may be equipped with a Reversing Fan.

The function of the reversing fan is to clear dust and debris from the rear grille. This is accomplished by reversing the direction of the cooling fan for several seconds.

The operator can select automatic or manual operation of the reversing fan.

Figure 89

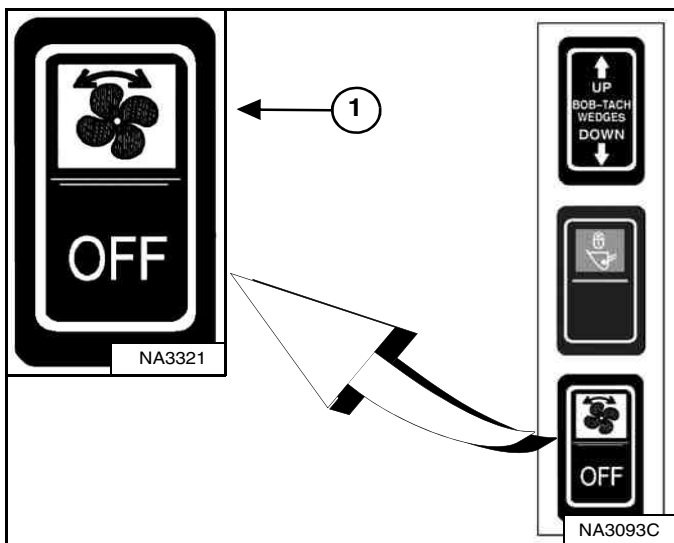

Automatic:

- Press the top of the Reversing Fan switch (Item 1) [Figure 89] on the right switch panel to put the switch into the middle position.
- The machine will reverse the fan automatically based on fluid temperature as long as automatic operation is selected.

Manual:

- Fully press the top of the Reversing Fan switch (Item 1) [Figure 89] on the right switch panel to perform one reversing cycle.
- The switch will return to automatic operation when released.

The top of the switch will light in the Automatic and Manual positions.

Press the bottom of the switch to disengage.

NOTE: To protect vital systems, the fan will not reverse when fluid temperatures approach overheating conditions. Cleaning or servicing the cooling system may be required to continue operation. (See Cleaning (Later Models) on Page 151.)

Figure 90



Reversing fan is disabled when the engine coolant or hydraulic fluid temperature is too high or too low.

Selecting manual operation of the reversing fan when disabled will cause the following indications:

1. The alarm will beep once.
2. Service code [RFOFF] will appear in the data display [Figure 90] for several seconds.

HYDRAULIC CONTROLS (CONT'D)

FRONT Auxiliary Hydraulics Operation

Figure 91



Press the Auxiliary Hydraulics button (Item 2) [Figure 91] once to activate the auxiliary hydraulics.

The light (Item 1) [Figure 91] is ON.

Standard, ACS, And AHC (If Equipped)

Figure 92

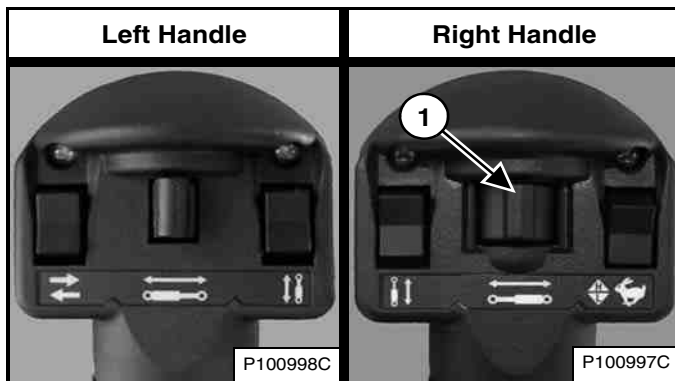

SJC (If Equipped)

Figure 93

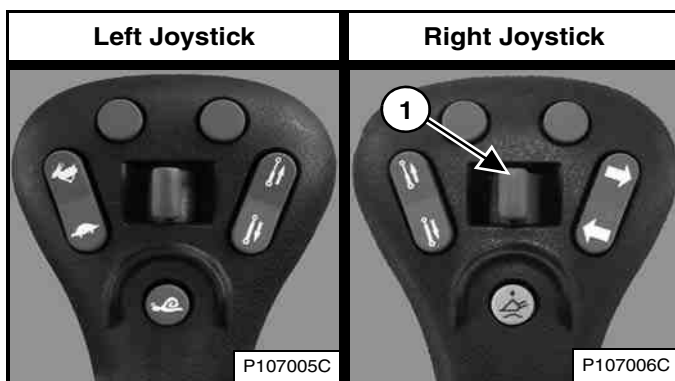

Move the Front Auxiliary Hydraulic switch (Item 1) [Figure 92] or [Figure 93] to the right or left to change direction of the auxiliary hydraulic fluid flow to the front quick couplers. If you move the switch halfway, the auxiliary functions move at approximately one-half speed. (EXAMPLE: Open and close grapple teeth.)

Release the Front Auxiliary Hydraulic switch to stop hydraulic fluid flow to the front quick couplers.

To deactivate the auxiliary hydraulics, press the Auxiliary Hydraulics button (Item 2) [Figure 91] again.

The light (Item 1) [Figure 91] is OFF.

NOTE: When the operator is seated and raises the seat bar, the Auxiliary Hydraulic System (Front and Rear) will deactivate.

HYDRAULIC CONTROLS (CONT'D)

FRONT Auxiliary Hydraulics Operation (CONTINUOUS FLOW)

Standard, ACS, And AHC (If Equipped)

Figure 94

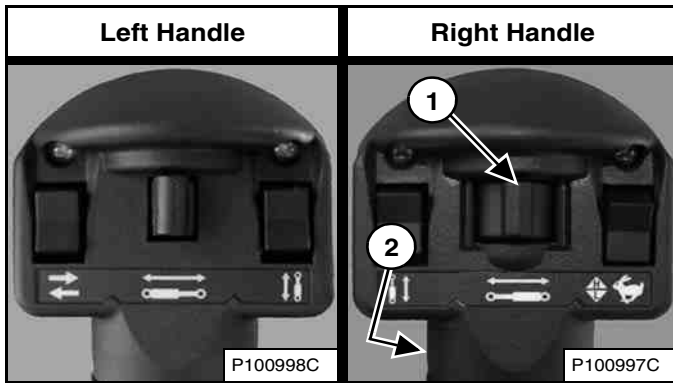

SJC (If Equipped)

Figure 95

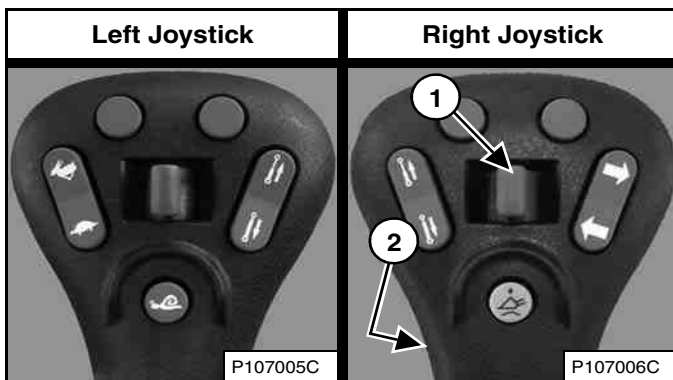

After activating the auxiliary hydraulics, press the Continuous Flow Control switch (Item 2) [Figure 94] or [Figure 95] to allow constant auxiliary hydraulic fluid flow to the front female coupler (female coupler is pressurised). (EXAMPLE: Operate a backhoe.)

To stop continuous auxiliary hydraulic fluid flow, press the Continuous Flow Control switch (Item 2) [Figure 94] or [Figure 95] a second time.

NOTE: When the operator is seated and raises the seat bar, the Auxiliary Hydraulic System (Front and Rear) will deactivate.

FRONT Auxiliary Hydraulics Operation (REVERSE CONTINUOUS FLOW)

To allow constant auxiliary hydraulic fluid flow to the front male coupler (male coupler is pressurised):

1. Activate the auxiliary hydraulics.
2. Move the Front Auxiliary Hydraulic switch (Item 1) [Figure 94] or [Figure 95] to the left and hold.
3. Press the Continuous Flow Control switch (Item 2) [Figure 94] or [Figure 95].
4. Release the Front Auxiliary Hydraulic switch.

NOTE: Reverse flow can cause damage to some attachments. Use reverse flow with your attachment only if approved. See your attachment Operation & Maintenance Manual for detailed information.

To stop reverse continuous auxiliary hydraulic fluid flow, press the Continuous Flow Control switch (Item 2) [Figure 94] or [Figure 95] a second time.

NOTE: When the operator is seated and raises the seat bar, the Auxiliary Hydraulic System (Front and Rear) will deactivate.

HYDRAULIC CONTROLS (CONT'D)

REAR Auxiliary Hydraulics Operation

This machine may be equipped with rear auxiliary hydraulics.

Figure 96



Press the Auxiliary Hydraulics button (Item 2) [Figure 96] once to activate the auxiliary hydraulics.

The light (Item 1) [Figure 96] is ON.

Standard, ACS, And AHC (If Equipped)

Figure 97

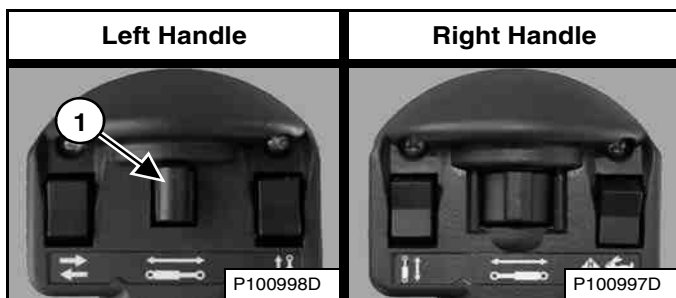

SJC (If Equipped)

Figure 98

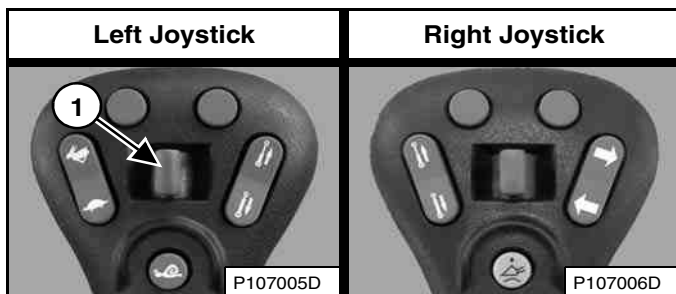
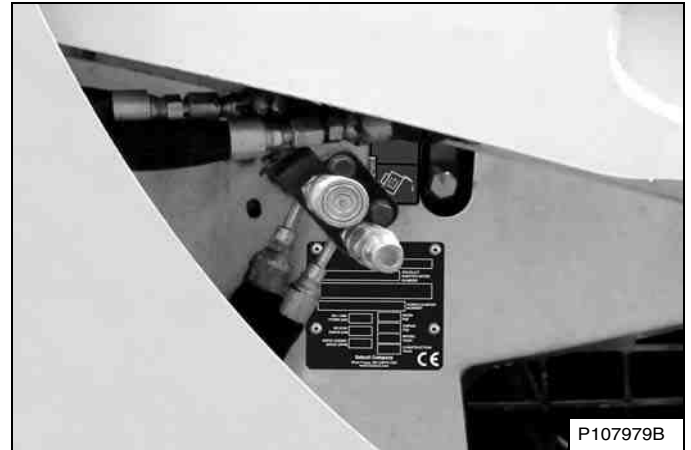

Figure 99



Move the Rear Auxiliary Hydraulic switch (Item 1) [Figure 97] or [Figure 98] to the right or left to change direction of the auxiliary hydraulic fluid flow to the rear quick couplers [Figure 99]. (EXAMPLE: Raise and lower rear stabilisers.) Release the switch to stop fluid flow.

To deactivate the auxiliary hydraulics, press the Auxiliary Hydraulics button (Item 2) [Figure 96] again.

The light (Item 1) [Figure 96] is OFF.

NOTE: When the operator is seated and raises the seat bar, the Auxiliary Hydraulic System (Front and Rear) will deactivate.

HYDRAULIC CONTROLS (CONT'D)

Quick Couplers



AVOID INJURY OR DEATH

Diesel fuel or hydraulic fluid under pressure can penetrate skin or eyes, causing serious injury or death. Fluid leaks under pressure may not be visible. Use a piece of cardboard or wood to find leaks. Do not use your bare hand. Wear safety goggles. If fluid enters skin or eyes, get immediate medical attention from a doctor familiar with this injury.

W-2072-EN-0909



AVOID BURNS

Hydraulic fluid, tubes, fittings and quick couplers can get hot when running machine and attachments. Be careful when connecting and disconnecting quick couplers.

W-2220-0396

NOTE: Follow attachment hose routing instructions in the attachment Operation & Maintenance Manual.

Figure 100

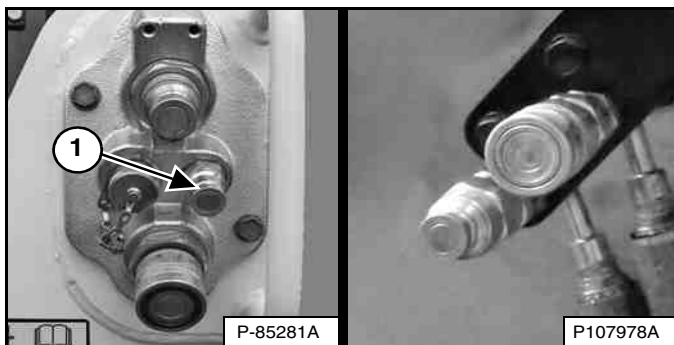

To Connect:

Remove dirt or debris from the surface of the male and female couplers, and from the outside diameter of the male couplers. Visually check the couplers for corroding, cracking, damage, or excessive wear. If any of these conditions exist, the coupler(s) [Figure 100] must be replaced.

Install the male couplers into the female couplers. Full connection is made when the ball release sleeves slide forward on the female couplers.

Some attachments have a case drain that needs to be connected to the small quick coupler (Item 1) [Figure 100].

To Disconnect:

Hold the male couplers. Retract the sleeves on the female couplers until couplers disconnect.

Quick Coupler Troubleshooting

Dirty couplers are often thought to be faulty and are unnecessarily replaced instead of simply being cleaned. Keep quick couplers clean to provide reliable service. Always clean coupler faces before connecting. Allowing dirt and other contaminants to remain can cause premature wear to internal seals and sealing surfaces.

Leaking Couplers

- Leaks are often caused by contaminants that prevent proper sealing of the couplers or that dislocate internal seals.
- Repeatedly connect and disconnect leaking couplers to dislodge contaminants.

Couplers Stuck In Open Position

- A gritty feel when moving the outer sleeve of female couplers or a coupler that remains open when disconnected is evidence of contamination.
- Retract the sleeves on the female couplers and clean thoroughly while rotating the sleeve until all contamination has been removed.
- Immediately clean a coupler stuck in the open position to prevent further contamination and leaks.

Difficult To Connect And Disconnect Couplers

- Attachment hoses that are out of alignment with the loader couplers can cause abnormal wear and make it difficult to connect and disconnect couplers.
- Ensure attachment hoses are routed exactly as shown in the attachment Operation & Maintenance Manual to prevent permanent coupler damage.

HYDRAULIC CONTROLS (CONT'D)

Relieve Auxiliary Hydraulic Pressure (Loader And Attachment)



AVOID BURNS

Hydraulic fluid, tubes, fittings and quick couplers can get hot when running machine and attachments. Be careful when connecting and disconnecting quick couplers.

W-2220-0396



AVOID INJURY OR DEATH

Diesel fuel or hydraulic fluid under pressure can penetrate skin or eyes, causing serious injury or death. Fluid leaks under pressure may not be visible. Use a piece of cardboard or wood to find leaks. Do not use your bare hand. Wear safety goggles. If fluid enters skin or eyes, get immediate medical attention from a doctor familiar with this injury.

W-2072-EN-0909

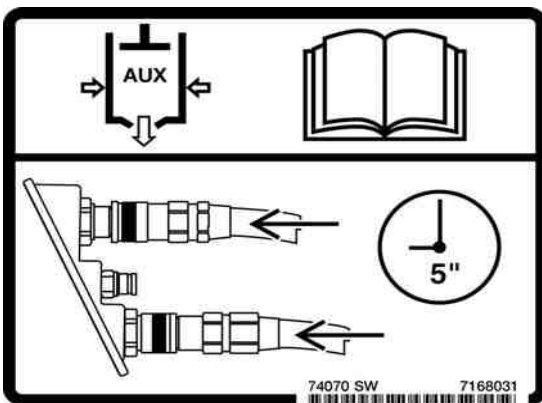

Front Auxiliary Quick Couplers

When Connecting: Push the quick couplers tightly together and hold for 5 seconds; the pressure is automatically relieved as the couplers are installed.

When Disconnecting: Push the quick couplers tightly together and hold for 5 seconds; then retract the sleeves until the couplers disconnect.

Rear Auxiliary Quick Couplers

Put the attachment flat on the ground. Stop the engine and turn the key switch to RUN.

Figure 101



Press the Auxiliary Hydraulics button (Item 1) [Figure 101].

Standard, ACS, And AHC (If Equipped)

Figure 102

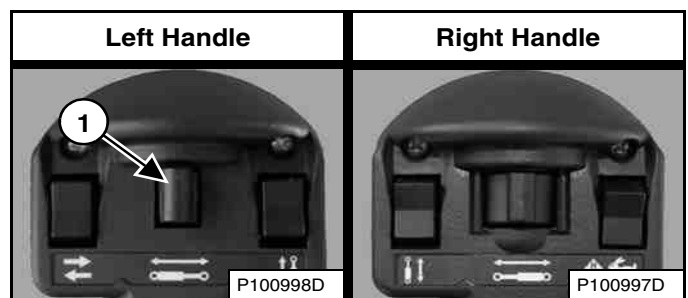

SJC (If Equipped)

Figure 103

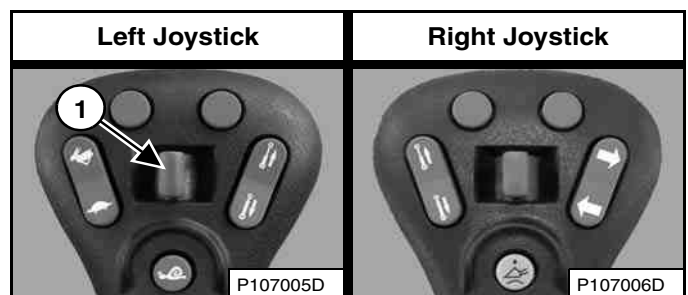

Move the Rear Auxiliary Hydraulic switch (Item 1) [Figure 102] or [Figure 103] to the left and right several times. Turn the key switch to STOP.

ATTACHMENT CONTROL DEVICE (ACD)

This machine may be equipped with an Attachment Control Device.

Description

Figure 104

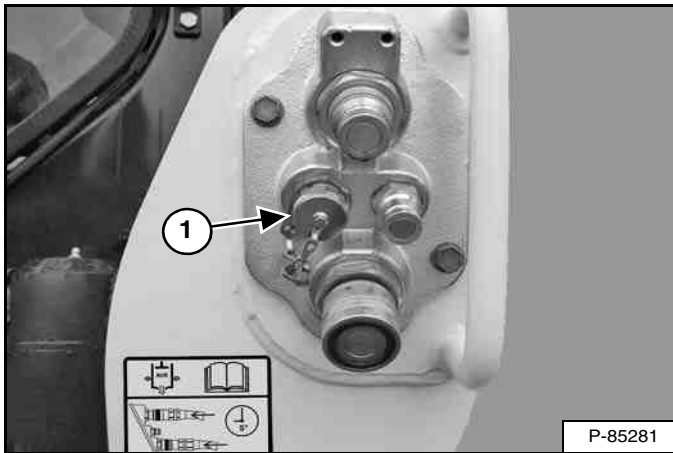

Connect the attachment electrical harness to the attachment control device (Item 1) [Figure 104].

Figure 105

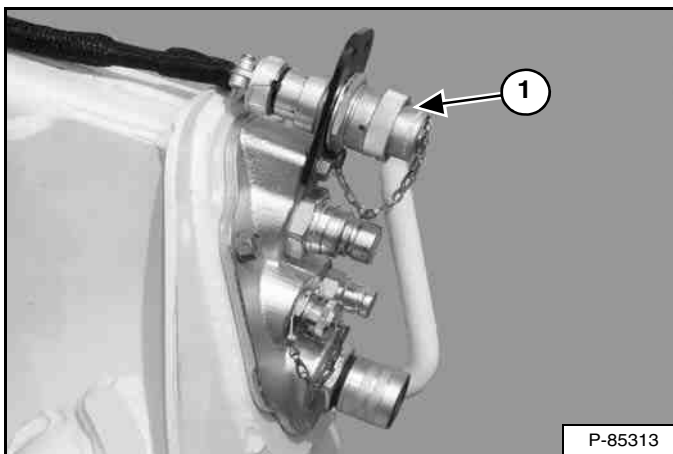

You will need the 14-Pin Attachment Control Device kit (Item 1) [Figure 105] to operate early model attachments. See your Bobcat loader dealer.

Standard, ACS, And AHC (If Equipped)

Figure 106

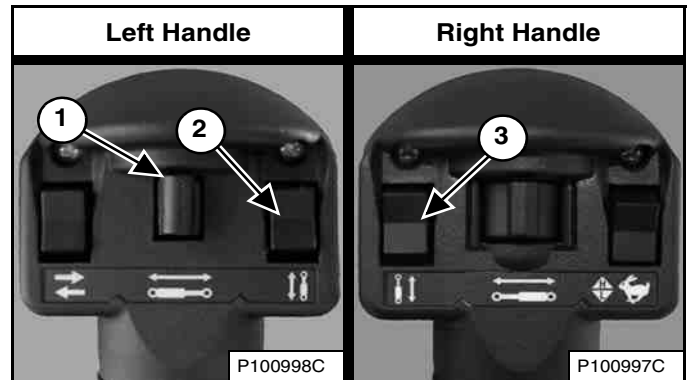

SJC (If Equipped)

Figure 107

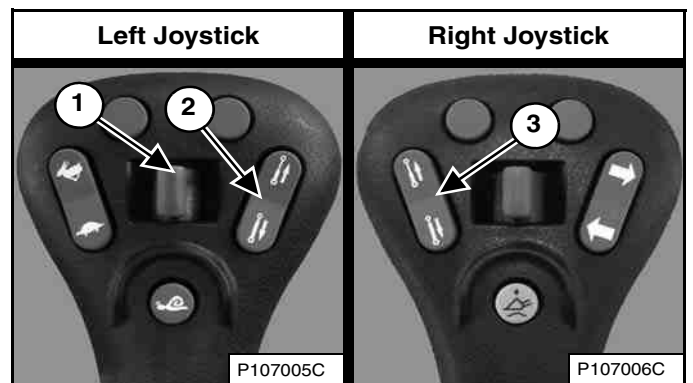

Additional switches (Items 1, 2, and 3) [Figure 106] or [Figure 107] are used to control some attachment functions through the attachment control device.

NOTE: ACD takes over the function of the Rear Auxiliary Hydraulic switch (Item 1) [Figure 106] or [Figure 107] from rear auxiliary hydraulics when an attachment electrical harness is attached to the ACD.

See the appropriate attachment Operation & Maintenance Manual for control details.

DAILY INSPECTION

Daily Inspection And Maintenance

Maintenance work must be done at regular intervals. Failure to do so will result in excessive wear and early failures. The Service Checklist And Schedule is a guide for correct maintenance of the Bobcat loader.

Figure 108



The Service Checklist And Schedule (Item 1) [Figure 108] is located inside the rear door of the loader.

A complete list of scheduled maintenance tasks is also located in the Preventive Maintenance section of this manual. (See SERVICE SCHEDULE on Page 122.)

WARNING

AVOID INJURY OR DEATH

- Keep door / cover closed except for service.
- Keep engine clean of flammable material.
- Keep body, loose objects and clothing away from electrical contacts, moving parts, hot parts and exhaust.
- Do not use the machine in space with explosive dusts or gases or with flammable material near exhaust.
- Never use ether or starting fluid on diesel engine with glow plugs or air intake heater. Use only starting aids as approved by engine manufacturer.
- Leaking fluids under pressure can enter skin and cause serious injury.
- Battery acid causes severe burns; wear goggles. If acid contacts eyes, skin, or clothing, flush with water. For contact with eyes, flush and get medical attention.
- Battery makes flammable and explosive gas. Keep arcs, sparks, flames and lighted tobacco away.
- For jump start, connect negative cable to the machine engine last (never at the battery). After jump start, remove negative connection at the engine first.
- Exhaust gases can kill. Always ventilate.

W-2782-0409

NOTE: Fluids such as engine oil, hydraulic fluid, and coolant must be disposed of in an environmentally safe manner. Some regulations require that certain spills and leaks on the ground must be cleaned in a specific manner. See local regulations for correct disposal.

WARNING

Operator must have instructions before operating the machine. Untrained operators can cause injury or death.

W-2001-0502



DAILY INSPECTION (CONT'D)

Daily Inspection And Maintenance (Cont'd)

The following list of items must be checked daily:

- Engine Oil Level
- Hydraulic Fluid Level
- Engine Air Cleaner - Check System for Damage or Leaks
- Engine Cooling System - Check System for Damage or Leaks, Check Coolant Level, Clean Hydraulic Fluid Cooler, Fuel Cooler, Radiator, and Rear Grille
- Operator Cab and Cab Mounting Hardware
- Seat Belt
- Seat Bar and Control Interlocks
- Bobcat Interlock Control System (BICS™)
- Front Horn - Check for Proper Function
- Grease Pivot Pins (Lift Arms, Lift Links, Bob-Tach, Cylinders, Bob-Tach Wedges)
- Tyres - Check for Wear, Damage, Correct Air Pressure
- Fuel Filter - Remove Trapped Water
- Loose or Broken Parts - Repair or Replace as Necessary
- Safety Treads and Safety Signs (Decals) - Replace as Necessary
- Lift Arm Support Device - Replace if Damaged

IMPORTANT

This machine is factory equipped with a spark arrester exhaust system that must be maintained for proper function.

- **WITH MUFFLER**
The muffler chamber must be emptied every 100 hours of operation to keep it in working condition.
- **WITH SELECTIVE CATALYST REDUCTION (SCR) AND / OR DIESEL OXIDATION CATALYST (DOC)**
Do not remove or modify the DOC or SCR.

The SCR must be maintained according to the instructions in the Operation & Maintenance Manual for proper function.

- **WITH DIESEL PARTICULATE FILTER (DPF)**
The DPF must be maintained according to the instructions in the Operation & Maintenance Manual for proper function.

(If this machine is operated on flammable forest, brush or grass cover land, a spark arrester attached to the exhaust system may be required and must be maintained in working order. Refer to local laws and regulations for spark arrester requirements.)

I-2350-EN-1114

IMPORTANT

PRESSURE WASHING DECALS

- Never direct the stream at a low angle toward the decal that could damage the decal causing it to peel from the surface.
- Direct the stream at a 90 degree angle and at least 300 mm (12 in) from the decal. Wash from the centre of the decal toward the edges.

I-2226-EN-0910

PRE-STARTING PROCEDURE

Entering The Loader

Figure 109



Use the bucket or attachment steps, grab handles, and safety treads (on the loader lift arms and frame) to get on and off the loader, maintaining a three-point contact at all times [Figure 109]. Do not jump.

Safety treads are installed on the Bobcat loader to provide a slip resistant surface for getting on and off the loader.

Keep safety treads clean and replace when damaged. Replacement treads are available from your Bobcat dealer.

Operation & Maintenance Manual And Operator's Handbook Locations

Figure 110

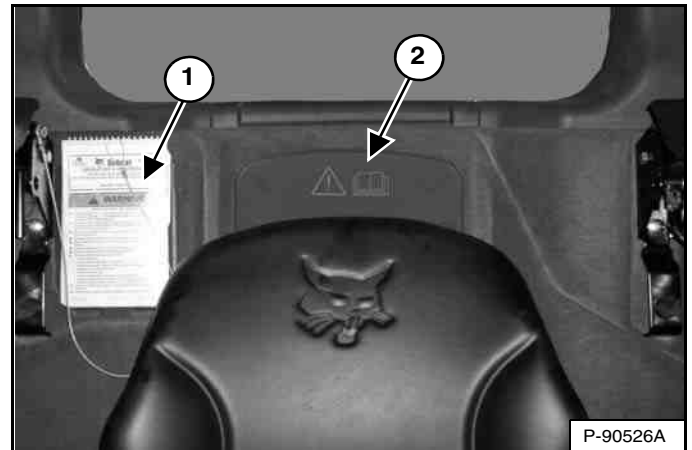

Read and understand the Operation & Maintenance Manual and the Operator's Handbook (Item 1) [Figure 110] before operating the loader.

The Operation & Maintenance Manual and other manuals can be kept in a container (Item 2) [Figure 110] provided behind the operator seat.

WARNING

AVOID INJURY OR DEATH

Instructions are necessary before operating or servicing machine. Read and understand the Operation & Maintenance Manual, Operator's Handbook and signs (decals) on machine. Follow warnings and instructions in the manuals when making repairs, adjustments or servicing. Check for correct function after adjustments, repairs or service. Untrained operators and failure to follow instructions can cause injury or death.

W-2003-0807

PRE-STARTING PROCEDURE (CONT'D)

Seat Adjustment

Suspension Seat (Standard)

Figure 111

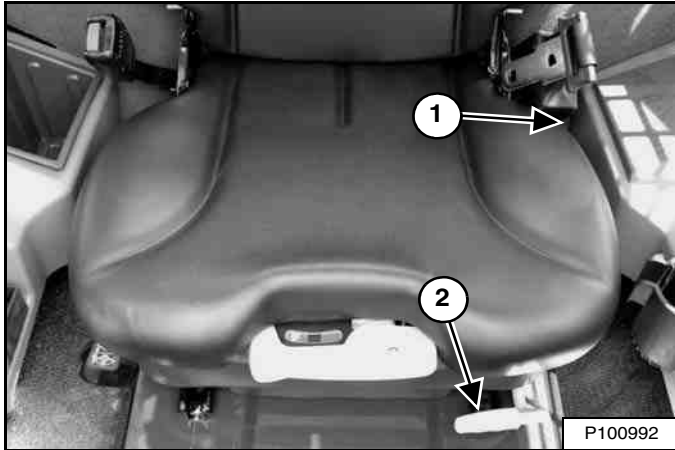

Pull the lever (Item 1) [Figure 111] up to adjust the angle of the seat back.

Pull the lever (Item 2) [Figure 111] up to adjust the seat position for comfortable operation of the loader controls.

Figure 112

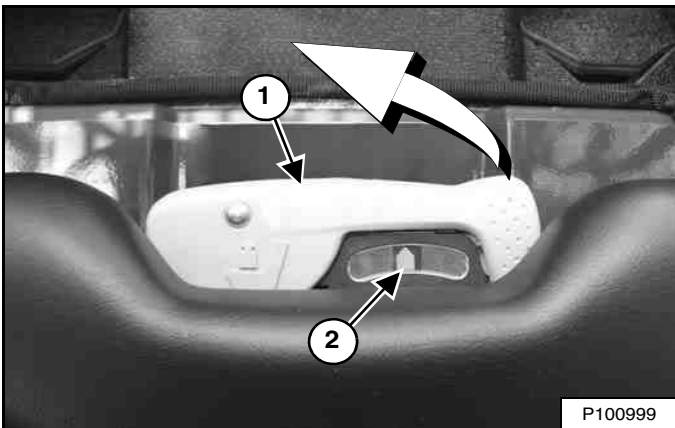

The lever (Item 1) is used to adjust the suspension response of the seat depending on the operator's weight. The optimum setting is achieved with the needle (Item 2) [Figure 112] centred in the gauge with the operator normally seated.

Pivot the lever out fully to adjust the setting. Pump lever between middle and upper positions to move the needle to the right. Pump lever between middle and lower positions to move the needle to the left. Return lever to the middle position and pivot lever back fully to lock in setting.

Air Ride Suspension Seat (Option)

Figure 113

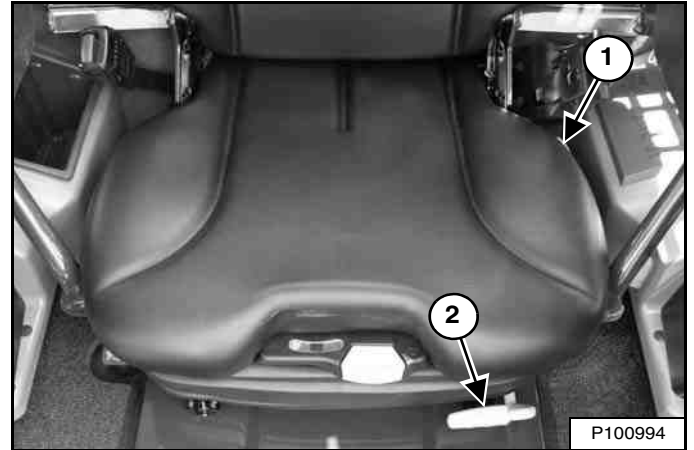

Pull the lever (Item 1) [Figure 113] up to adjust the angle of the seat back.

Pull the lever (Item 2) [Figure 113] up to adjust the seat position for comfortable operation of the loader controls.

Figure 114

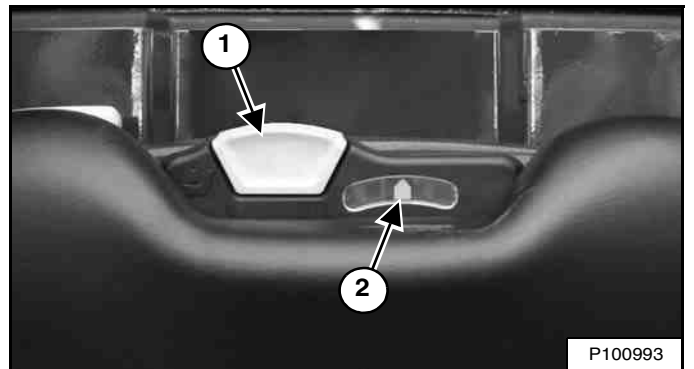

The lever (Item 1) is used to adjust the suspension response of the seat depending on the operator's weight. The optimum setting is achieved with the needle (Item 2) [Figure 114] centred in the gauge with the operator normally seated.

Pull the lever (Item 1) [Figure 114] up and hold to increase the amount of air in the seat suspension. Push the lever down and hold to decrease the amount of air in the seat suspension.

NOTE: The loader electrical system must be turned ON to increase the amount of air in the seat suspension.

PRE-STARTING PROCEDURE (CONT'D)

Seat Belt Adjustment

Standard Seat Belt

Figure 115



Pull the lap belt across to the right side of the seat and fasten **[Figure 115]**.

The lap belt must be positioned over your lower hips.

IMPORTANT

Check the seat belt retractor for correct operation. Keep retractor clean and replace as necessary.

I-2252-0707

3-Point Restraint (Option And Loaders Equipped With Two-Speed)

Figure 116

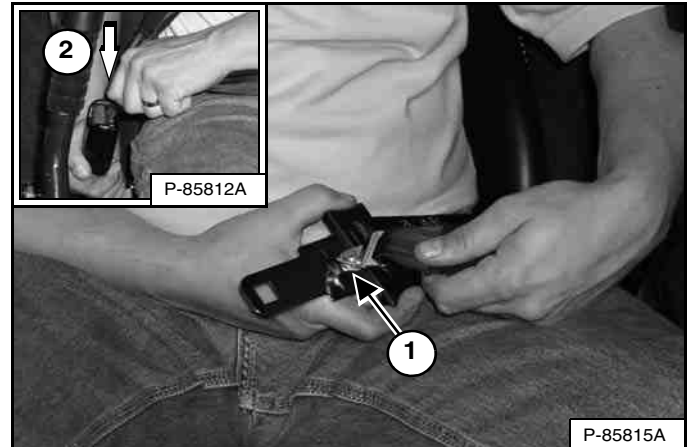

Connect the shoulder belt to the lap belt (Item 1). Pull the lap belt across to the right side of the seat and fasten (Item 2) **[Figure 116]**.

The shoulder belt must be positioned over your left shoulder and lap belt over your lower hips.

IMPORTANT

Check the seat belt and shoulder belt retractors for correct operation.

Keep retractors clean and replace as necessary.

I-2199-0200

PRE-STARTING PROCEDURE (CONT'D)

Seat Bar

Figure 117



Lower the seat bar and engage the parking brake [Figure 117].

Put the foot pedals or hand controls in NEUTRAL position.

NOTE: Keep your hands on the steering levers and your feet on the foot pedals (or footrests) while operating the loader.

Joystick Position Adjustment

Joystick Position Adjustment is available on SJC equipped machines.

Figure 118

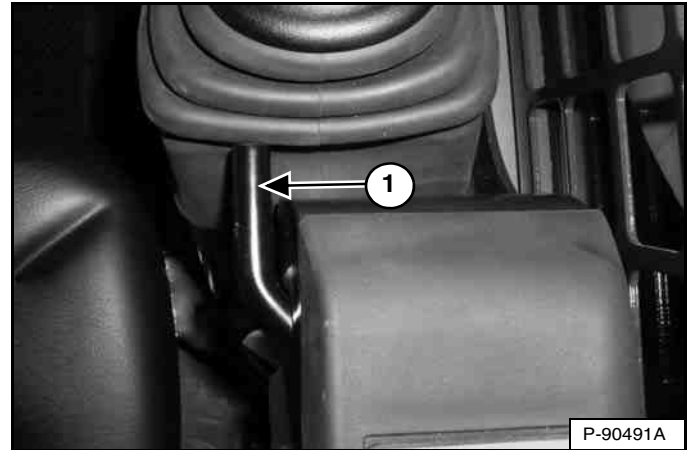

Pull the joystick adjustment levers (Item 1) [Figure 118] up to slide the loader joysticks forward or backward to adjust for comfortable operation. (Right side shown.)

WARNING

AVOID INJURY OR DEATH

When operating the machine:

- Keep the seat belt fastened snugly.
- The seat bar must be lowered.
- Keep your feet on the pedal controls or footrests and hands on the controls.

W-2261-0909

STARTING THE ENGINE

Standard Key Panel

! WARNING

AVOID SERIOUS INJURY OR DEATH

- Engines can have hot parts and hot exhaust gas. Keep flammable material away.
- Do not use machines in atmosphere containing explosive dust or gases.

W-2051-0212

Perform the PRE-STARTING PROCEDURE. (See PRE-STARTING PROCEDURE on Page 92.)

Figure 119



Set the engine speed control to the low idle position [Figure 119].

Figure 120

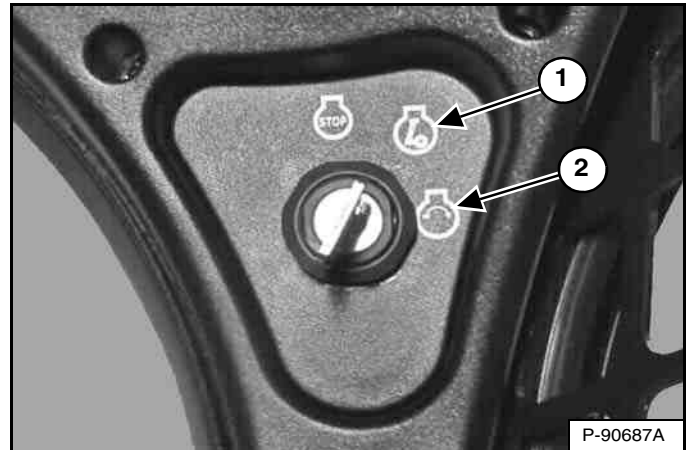

Turn the key switch to RUN (Item 1) [Figure 120]. The indicator lights on the left instrument panel will come ON briefly and the instrument panel / monitoring system will perform a self test.

Figure 121

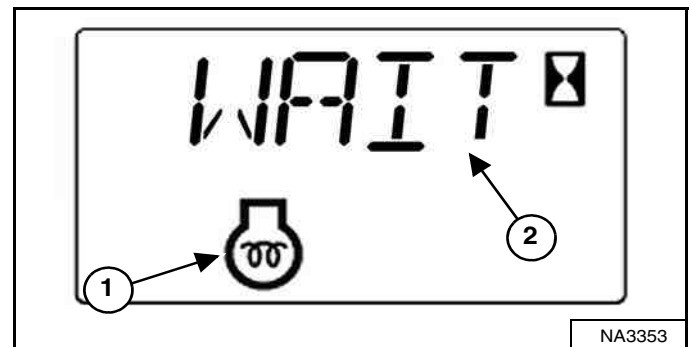

The machine will cycle the glow plugs automatically based on temperature. The engine preheat icon (Item 1) and the cycle time remaining or [WAIT] (Item 2) [Figure 121] are displayed in the data display.

When the engine preheat icon goes OFF, turn the key switch to START (Item 2). Release the switch when the engine starts and allow the switch to return to the RUN position (Item 1) [Figure 120].

STARTING THE ENGINE (CONT'D)

Standard Key Panel (Cont'd)

NOTE: Make sure both hand controls (ACS / AHC) or joysticks (SJC) are in the NEUTRAL position before starting the engine. Do not move the levers or joysticks from the NEUTRAL position when turning the key switch to RUN or START with the BICS™ activated.



AVOID INJURY OR DEATH

- Fasten seat belt, start and operate only from the operator's seat.
- Never wear loose clothing when working near machine.

W-2135-1108

Figure 122

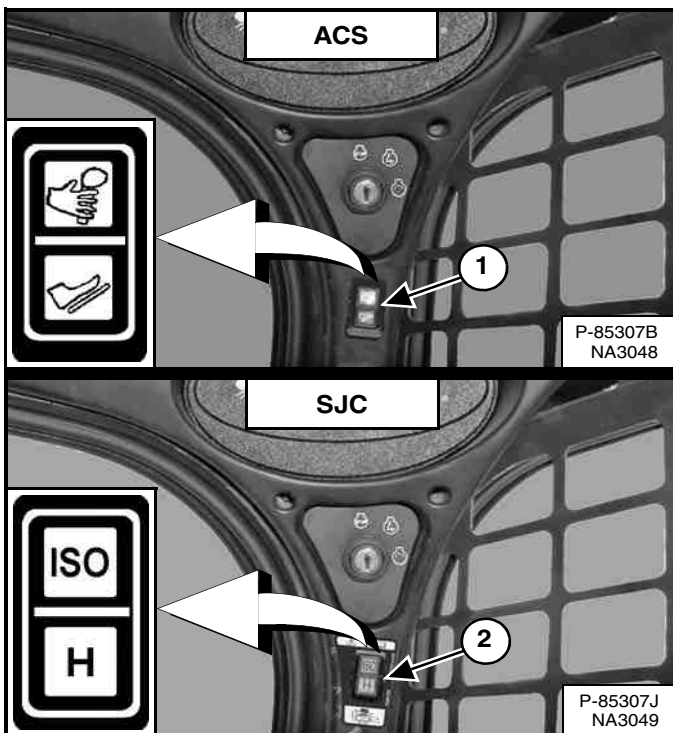

(ACS) Select hand control or foot pedal operation (Item 1) [Figure 122] if equipped with ACS.

OR

(SJC) Select 'ISO' or 'H' Control Pattern (Item 2) [Figure 122] if equipped with SJC.

Figure 123

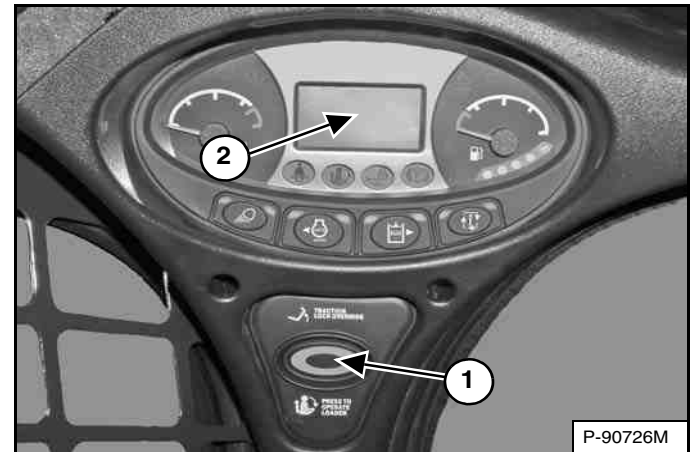

Press the PRESS TO OPERATE LOADER button (Item 1) [Figure 123] to activate the BICS™ and to perform hydraulic and loader functions.

(SJC) The current drive response setting is displayed briefly in the data display (Item 2) each time the PRESS TO OPERATE LOADER button (Item 1) [Figure 123] is pressed.

NOTE: (SJC) The light of the current switch position (ISO or H) will flash, which indicates PRESS TO OPERATE LOADER is required. The light will flash when the key switch is in the RUN position and continue to flash until the PRESS TO OPERATE LOADER button is pressed, then the light will become solid. If the mode (ISO / H) is changed while driving, the active mode light will remain solid and the pending mode light will flash. When operation of the machine is returned to NEUTRAL, the active mode light will turn off and the pending mode light will continue to flash until the PRESS TO OPERATE LOADER button is pressed.



AVOID INJURY OR DEATH

When an engine is running in an enclosed area, fresh air must be added to avoid concentration of exhaust fumes. If the engine is stationary, vent the exhaust outside. Exhaust fumes contain odorless, invisible gases which can kill without warning.

W-2050-0807

STARTING THE ENGINE (CONT'D)

Keyless Start Panel

WARNING

AVOID SERIOUS INJURY OR DEATH

- Engines can have hot parts and hot exhaust gas. Keep flammable material away.
- Do not use machines in atmosphere containing explosive dust or gases.

W-2051-0212

Perform the PRE-STARTING PROCEDURE. (See PRE-STARTING PROCEDURE on Page 92.)

Figure 124



Set the engine speed control to the low idle position [Figure 124].

NOTE: Loaders with a Keyless Start Panel have a permanent, randomly generated Master Password set at the factory. Your loader will also have an Owner Password. The owner password can be changed to prevent unauthorised use of your loader. (See Changing The Owner Password on Page 195.) Keep your password in a safe location for future needs.

NOTE: The Password Lockout feature can be used to allow starting of the loader without a password. (See Password Lockout Feature on Page 195.)

Figure 125

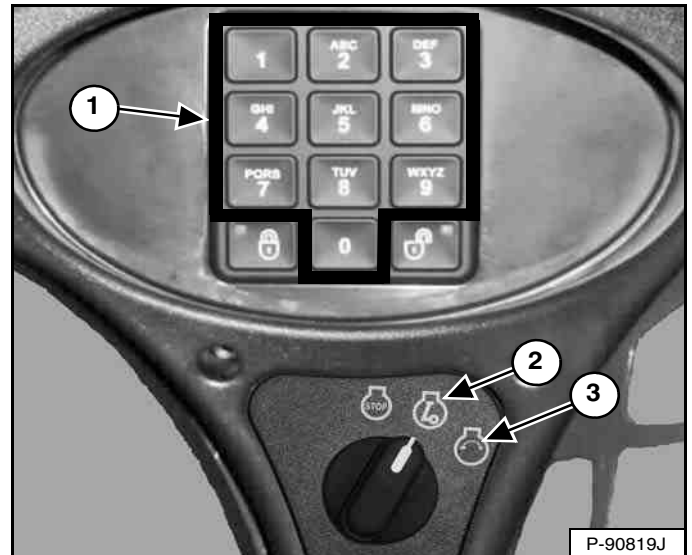

Turn the key switch to RUN (Item 2) [Figure 125]. The indicator lights on the left instrument panel will come ON briefly and the instrument panel / monitoring system will perform a self test.

Use the numeric keypad (Item 1) [Figure 125] to enter the password.

Figure 126

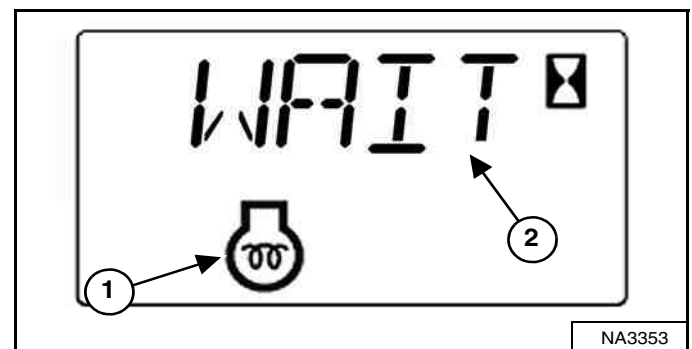

The machine will cycle the glow plugs automatically based on temperature. The engine preheat icon (Item 1) and the cycle time remaining or [WAIT] (Item 2) [Figure 126] are displayed in the data display.

When the engine preheat icon goes OFF, turn the key switch to START (Item 3). Release the switch when the engine starts and allow the switch to return to the RUN position (Item 2) [Figure 125].

STARTING THE ENGINE (CONT'D)

Keyless Start Panel (Cont'd)

NOTE: Make sure both hand controls (ACS / AHC) or joysticks (SJC) are in the NEUTRAL position before starting the engine. Do not move the levers or joysticks from the NEUTRAL position when turning the key switch to RUN or START with the BICS™ activated.



AVOID INJURY OR DEATH

- Fasten seat belt, start and operate only from the operator's seat.
- Never wear loose clothing when working near machine.

W-2135-1108

Figure 127

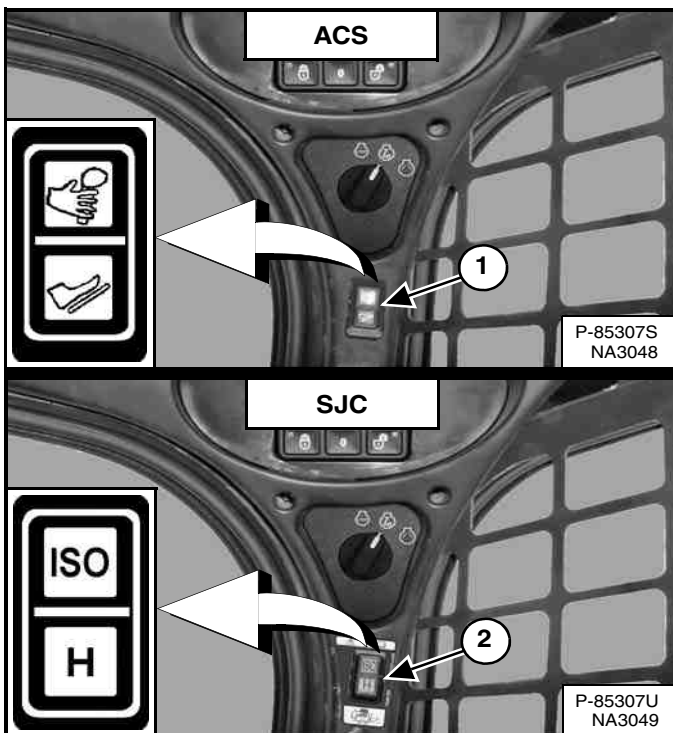

(ACS) Select hand control or foot pedal operation (Item 1) [Figure 127] if equipped with ACS.

OR

(SJC) Select 'ISO' or 'H' Control Pattern (Item 2) [Figure 127] if equipped with SJC.

Figure 128

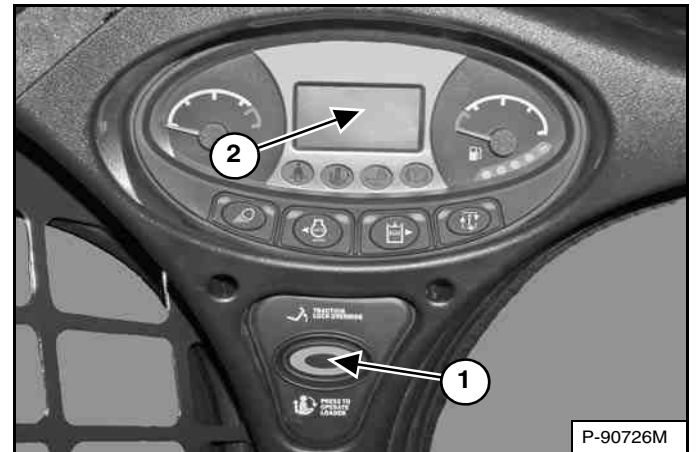

Press the PRESS TO OPERATE LOADER button (Item 1) [Figure 128] to activate the BICS™ and to perform hydraulic and loader functions.

(SJC) The current drive response setting is displayed briefly in the data display (Item 2) each time the PRESS TO OPERATE LOADER button (Item 1) [Figure 128] is pressed.

NOTE: (SJC) The light of the current switch position (ISO or H) will flash, which indicates PRESS TO OPERATE LOADER is required. The light will flash when the key switch is in the RUN position and continue to flash until the PRESS TO OPERATE LOADER button is pressed, then the light will become solid. If the mode (ISO / H) is changed while driving, the active mode light will remain solid and the pending mode light will flash. When operation of the machine is returned to NEUTRAL, the active mode light will turn off and the pending mode light will continue to flash until the PRESS TO OPERATE LOADER button is pressed.



AVOID INJURY OR DEATH

When an engine is running in an enclosed area, fresh air must be added to avoid concentration of exhaust fumes. If the engine is stationary, vent the exhaust outside. Exhaust fumes contain odorless, invisible gases which can kill without warning.

W-2050-0807

STARTING THE ENGINE (CONT'D)

Deluxe Instrumentation Panel

! WARNING

AVOID SERIOUS INJURY OR DEATH

- Engines can have hot parts and hot exhaust gas. Keep flammable material away.
- Do not use machines in atmosphere containing explosive dust or gases.

W-2051-0212

Perform the PRE-STARTING PROCEDURE. (See PRE-STARTING PROCEDURE on Page 92.)

Figure 129

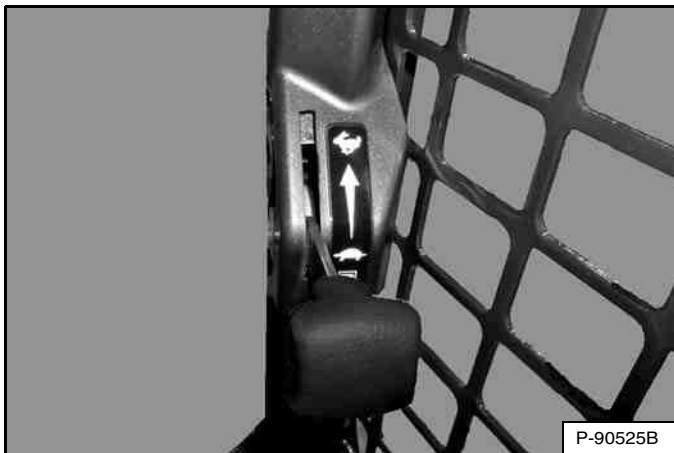

Set the engine speed control to the low idle position [Figure 129].

NOTE: Loaders with a Deluxe Instrumentation Panel have a permanent, randomly generated Master Password set at the factory. Your loader will also be assigned an Owner Password. Your dealer will provide you with this password. Change the owner password to one that you will easily remember to prevent unauthorised use of your loader. (See Changing The Owner Password on Page 196.) Keep your password in a safe location for future needs.

NOTE: The Password Lockout feature can be used to allow starting of the loader without a password. (See Password Lockout Feature on Page 197.)

Figure 130



Turn the key switch to RUN (Item 2) [Figure 130]. The indicator lights on the left instrument panel will come ON briefly and the instrument panel / monitoring system will perform a self test.

Use the numeric keypad (Item 1) [Figure 130] to enter the password.

Figure 131

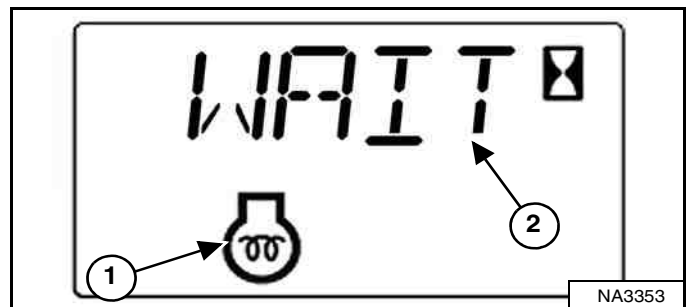

The machine will cycle the glow plugs automatically based on temperature. The engine preheat icon (Item 1) and the cycle time remaining or [WAIT] (Item 2) [Figure 131] are displayed in the data display.

NOTE: The Deluxe Instrumentation Panel display screen will also display an engine preheat icon and [WAIT TO START].

When the engine preheat icon goes OFF, turn the key switch to START (Item 3). Release the switch when the engine starts and allow the switch to return to the RUN position (Item 2) [Figure 130].

STARTING THE ENGINE (CONT'D)

Deluxe Instrumentation Panel (Cont'd)

NOTE: Make sure both hand controls (ACS / AHC) or joysticks (SJC) are in the NEUTRAL position before starting the engine. Do not move the levers or joysticks from the NEUTRAL position when turning the key switch to RUN or START with the BICS™ activated.



AVOID INJURY OR DEATH

- Fasten seat belt, start and operate only from the operator's seat.
- Never wear loose clothing when working near machine.

W-2135-1108

Figure 132

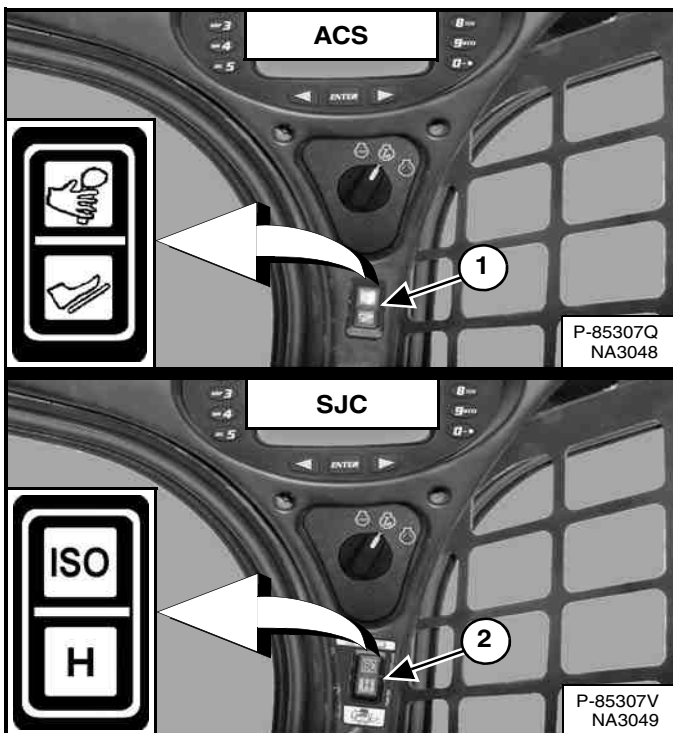

(ACS) Select hand control or foot pedal operation (Item 1) [Figure 132] if equipped with ACS.

OR

(SJC) Select 'ISO' or 'H' Control Pattern (Item 2) [Figure 132] if equipped with SJC.

Figure 133

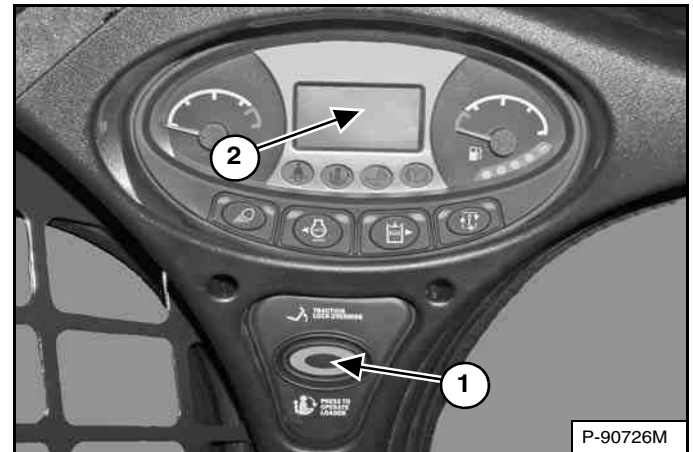

Press the PRESS TO OPERATE LOADER button (Item 1) [Figure 133] to activate the BICS™ and to perform hydraulic and loader functions.

(SJC) The current drive response setting is displayed briefly in the data display (Item 2) each time the PRESS TO OPERATE LOADER button (Item 1) [Figure 133] is pressed.

NOTE: (SJC) The light of the current switch position (ISO or H) will flash, which indicates PRESS TO OPERATE LOADER is required. The light will flash when the key switch is in the RUN position and continue to flash until the PRESS TO OPERATE LOADER button is pressed, then the light will become solid. If the mode (ISO / H) is changed while driving, the active mode light will remain solid and the pending mode light will flash. When operation of the machine is returned to NEUTRAL, the active mode light will turn off and the pending mode light will continue to flash until the PRESS TO OPERATE LOADER button is pressed.



AVOID INJURY OR DEATH

When an engine is running in an enclosed area, fresh air must be added to avoid concentration of exhaust fumes. If the engine is stationary, vent the exhaust outside. Exhaust fumes contain odorless, invisible gases which can kill without warning.

W-2050-0807



STARTING THE ENGINE (CONT'D)

Warming The Hydraulic / Hydrostatic System

Let the engine operate for a minimum of 5 minutes to warm the engine and hydrostatic transmission fluid before operating the loader.

IMPORTANT

When the temperature is below -30°C (-20°F), hydrostatic oil must be warmed before starting. The hydrostatic system will not get enough oil at low temperatures and will be damaged. Park the machine in an area where the temperature will be above -18°C (0°F) if possible.

I-2007-0910

Cold Temperature Starting

WARNING

EXPLOSION CAN CAUSE SERIOUS INJURY, DEATH OR SEVERE ENGINE DAMAGE
DO NOT use ether or starting fluid with glow plug or air intake heater systems.

W-2071-0415

If the temperature is below freezing, perform the following to make starting the engine easier:

- Replace the engine oil with the correct type and viscosity for the anticipated starting temperature. (See Engine Oil Chart on Page 147.)
- Make sure the battery is fully charged.
- Install an engine heater, available from your Bobcat loader dealer.
- Move engine speed control halfway before starting. Return to idle position after the engine starts.

NOTE: The display screen of the Deluxe Instrumentation Panel may not be at full intensity when the temperature is below -26°C (-15°F). The display screen may take 30 seconds to several minutes to warm up. All systems remain monitored even when the display screen is off.

MONITORING THE DISPLAY PANELS

Left Panel

Figure 134



Frequently monitor the temperature and fuel gauges and BICS™ lights (all BICS™ lights must be OFF to operate loader) [Figure 134].

After the engine is running, frequently monitor the left instrument panel [Figure 134] for machine condition.

The associated icon is displayed if there is an error condition.

EXAMPLE: Engine Coolant Temperature is High.

The Engine Coolant Temperature icon (Item 1) [Figure 134] is ON.

Press the Information button (Item 2) [Figure 134] to cycle the data display until the service code screen is displayed. One of the following SERVICE CODES is displayed.

- [M0810] Engine Coolant Temperature Too High
- [M0811] Engine Coolant Temperature Extremely High

Find the cause of the service code and correct before operating the loader again. (See Service Codes List on Page 185.)

NOTE: The optional Deluxe Instrumentation Panel offers an additional view of service codes that includes a brief description. (See Viewing Service Codes on Page 184.)

Warning And Shutdown

When a WARNING condition exists; the associated icon light is ON and the alarm sounds 3 beeps. If this condition is allowed to continue, there may be damage to the engine or loader hydraulic systems.

When a SHUTDOWN condition exists; the associated icon light is ON and the alarm sounds continuously. The monitoring system will automatically stop the engine in 15 seconds. The engine can be restarted to move or relocate the loader.

The SHUTDOWN feature is associated with the following icons:

- General Warning**
- Engine Malfunction**
- Engine Coolant Temperature**
- Hydraulic System Malfunction**

STOPPING THE ENGINE AND LEAVING THE LOADER

Procedure

Stop the loader on level ground.

Fully lower the lift arms and put the attachment flat on the ground.

Figure 135



Set the engine speed control to the low idle position [Figure 135].

Engage the parking brake.

Figure 136

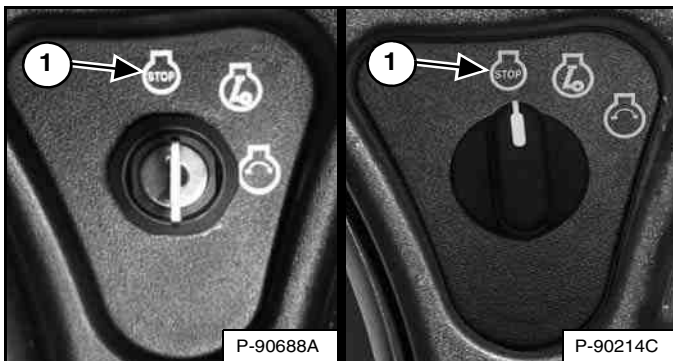

Turn the key switch to the STOP position (Item 1) [Figure 136].

NOTE: If the loader lights are ON, they will remain ON for approximately 90 seconds after turning the loader OFF.

Raise the seat bar and make sure the lift and tilt functions are deactivated.

Unbuckle the seat belt.

(Standard Key Panel) Remove the key from the switch to prevent operation of the loader by unauthorised personnel.

NOTE: Activating the Password Lockout Feature on machines with the Keyless Start Panel or the Deluxe Instrumentation Panel allows operation of the loader without using a password. (See Password Lockout Feature on Page 195.) or (See Password Lockout Feature on Page 197.)

Figure 137



Exit the loader using grab handles, safety treads, and steps (maintaining a three-point contact) [Figure 137].

WARNING

AVOID INJURY OR DEATH

Before you leave the operator's seat:

- Lower the lift arms and put the attachment flat on the ground.
- Stop the engine.
- Engage the parking brake.
- Raise the seat bar.
- Move all controls to the NEUTRAL / LOCKED position to make sure the lift, tilt and traction drive functions are deactivated.

The seat bar system must deactivate these functions when the seat bar is up. See your Bobcat dealer for service if controls do not deactivate.

W-2463-1110



COUNTERWEIGHTS

Description

Counterweights can be installed on the loader. See your Bobcat dealer for information about approved loader counterweights and configurations for your job application and attachment.

Effect On The Loader And Loader Operation

Proper operation of the loader and attachment does not change if counterweights are installed on this loader. Always follow the instructions provided in this manual when operating your loader with counterweights installed.

Counterweights installed on your loader can affect the loader and its operation in some applications. Some examples are:

- Increased machine weight.
- Increased Rated Operating Capacity (ROC).
- Harder steering.
- Accelerated or uneven tyre wear.
- Increased power consumption.

When To Consider Using Counterweights

Install counterweights to increase the loaders Rated Operating Capacity (ROC) which could improve attachment performance in some applications. Some examples are:

- Using pallet fork with palletised loads.
- Using grapples or bale fork.
- Using buckets to handle loose material without digging.

When To Consider Removing Counterweights

Remove counterweights to increase the downward force of the attachment for better attachment performance in some applications. Some examples are:

- Digging with buckets.
- Using Hydraulic Breakers, Scrapers, or Landplanes.

Accessories That Affect Machine Weight

If your loader is already equipped with accessories like Over Tyre Steel Tracks, Water Tanks, or Rear Stabilisers; installing counterweights may not be necessary.

See your Bobcat dealer for more information about the proper use of counterweights with approved attachments and accessories for your loader.

ATTACHMENTS

Choosing The Correct Bucket



AVOID INJURY OR DEATH

Never use attachments or buckets which are not approved by Bobcat Company. Buckets and attachments for safe loads of specified densities are approved for each model. Unapproved attachments can cause injury or death.

W-2052-0907

NOTE: Warranty is void if non-approved attachments are used on the Bobcat loader.

The dealer can identify, for each model loader, the attachments and buckets approved by Bobcat. The buckets and attachments are approved for Rated Operating Capacity (ROC) and for secure fastening to the Bob-Tach.

The ROC for this loader is shown on a decal in the operator cab. (See Performance on Page 201.)

The ROC is determined by using a bucket and material of normal density, such as dirt or dry gravel. If longer buckets are used, the load centre moves forward and reduces the ROC. If extremely dense material is loaded, the volume must be reduced to prevent overloading.

Figure 138

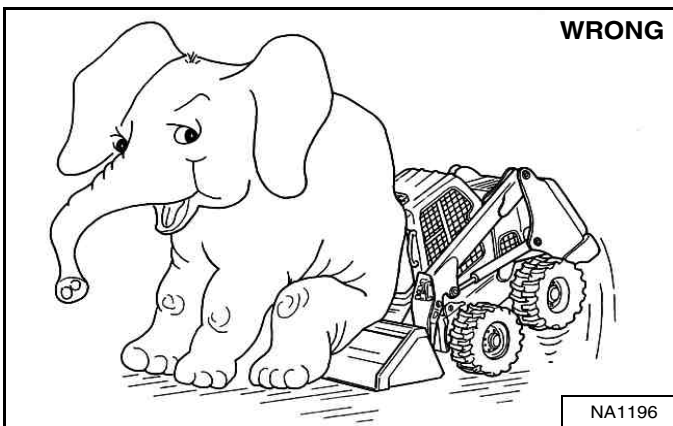

Exceeding the ROC [Figure 138] can cause the following problems:

- Steering the loader may be difficult.
- Tyres will wear faster.
- There will be a loss of stability.
- The life of the Bobcat loader will be reduced.

Use the correct bucket size for the type and density of material being handled. For safe handling of materials and avoiding machine damage, the attachment (or bucket) should handle a full load without going over the ROC for the loader. Partial loads make steering more difficult.

Pallet Fork

Figure 139

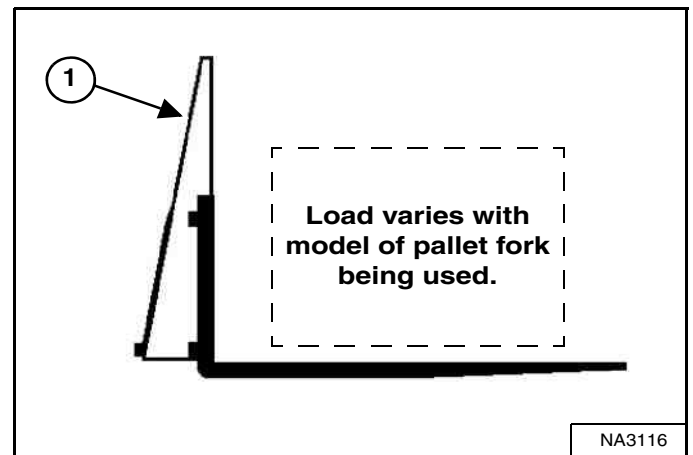

The maximum load to be carried when using a pallet fork is shown on a decal located on the pallet fork frame (Item 1) [Figure 139].

See your Bobcat dealer for more information about pallet fork inspection, maintenance, and replacement. See your Bobcat dealer for ROC when using a pallet fork and for other available attachments.



AVOID INJURY OR DEATH

Do not exceed Rated Operating Capacity (ROC). Excessive load can cause tipping or loss of control.

W-2053-0903

ATTACHMENTS (CONT'D)

Installing And Removing The Attachment (Hand Lever Bob-Tach)

The Bob-Tach is used for fast changing of buckets and attachments. See the appropriate attachment Operation & Maintenance Manual to install other attachments.

Installing

Figure 140

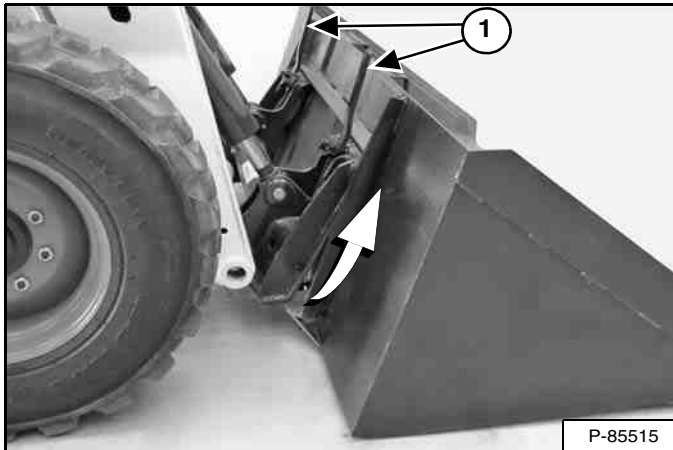

Pull the Bob-Tach levers up until they are fully raised (wedges fully raised) (Item 1) [Figure 140].

Enter the loader and perform the PRE-STARTING PROCEDURE. (See PRE-STARTING PROCEDURE on Page 92.)

Start the engine, press the PRESS TO OPERATE LOADER button, and release the parking brake.

Lower the lift arms and tilt the Bob-Tach forward.

Drive the loader slowly forward until the top edge of the Bob-Tach is completely under the top flange of the bucket mounting frame [Figure 140] (or other attachment).

NOTE Be sure the Bob-Tach levers do not hit the attachment.

Figure 141

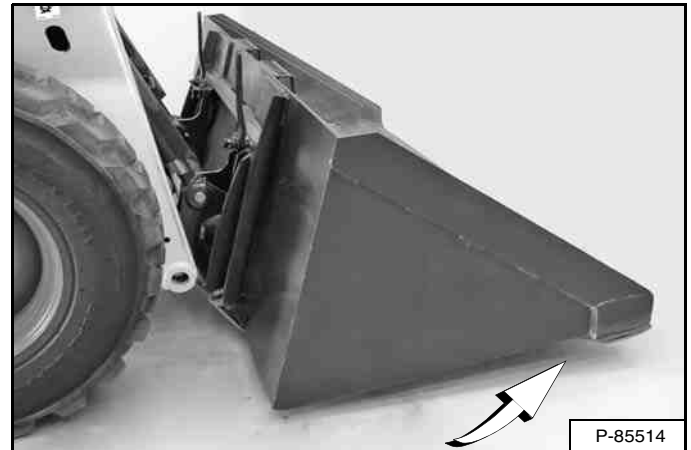

Tilt the Bob-Tach backward until the cutting edge of the bucket (or other attachment) is slightly off the ground [Figure 141]. This procedure will cause the bucket mounting frame to fit up against the front of the Bob-Tach.

Stop the engine and exit the loader. (See STOPPING THE ENGINE AND LEAVING THE LOADER on Page 104.)



WARNING

AVOID INJURY OR DEATH

Before you leave the operator's seat:

- Lower the lift arms and put the attachment flat on the ground.
- Stop the engine.
- Engage the parking brake.
- Raise the seat bar.
- Move all controls to the NEUTRAL / LOCKED position to make sure the lift, tilt and traction drive functions are deactivated.

The seat bar system must deactivate these functions when the seat bar is up. See your Bobcat dealer for service if controls do not deactivate.

W-2463-1110

ATTACHMENTS (CONT'D)

Installing And Removing The Attachment (Hand Lever Bob-Tach) (Cont'd)

Installing (Cont'd)

Figure 142

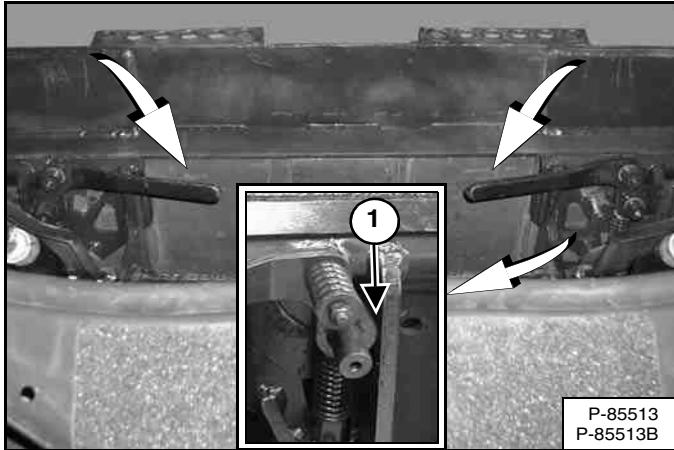

Push down on the Bob-Tach levers until they are fully engaged in the locked position [Figure 142] (wedges fully extended through the attachment mounting frame holes).

Both levers must contact the frame as shown when locked (Item 1) [Figure 142].

If both levers do not engage in the locked position, see your Bobcat dealer for maintenance.

Figure 143

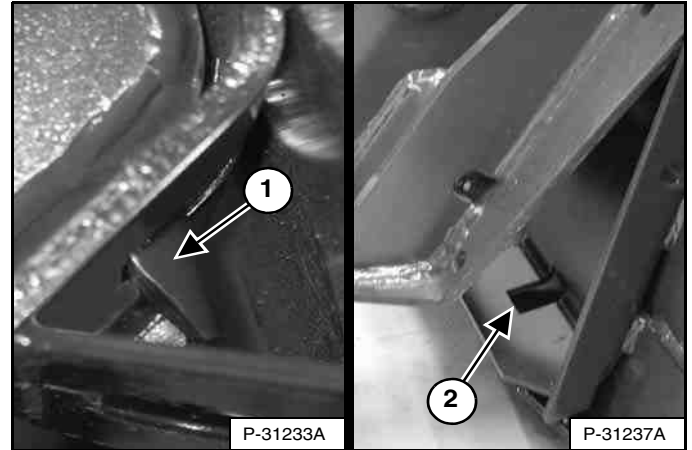

The wedges (Item 1) must extend through the holes (Item 2) [Figure 143] in the mounting frame of the bucket (or other attachment), securely fastening the bucket to the Bob-Tach.

! WARNING

AVOID INJURY OR DEATH

The Bob-Tach wedges must extend through the holes in the attachment mounting frame. Levers must be fully down and locked. Failure to secure wedges can allow attachment to come off.

W-2715-0208

ATTACHMENTS (CONT'D)

Installing And Removing The Attachment (Hand Lever Bob-Tach) (Cont'd)

Removing

Lower the lift arms and put the attachment flat on the ground. Lower or close any hydraulic equipment, if applicable.

Stop the engine and exit the loader. (See STOPPING THE ENGINE AND LEAVING THE LOADER on Page 104.)

! WARNING

AVOID INJURY OR DEATH

Before you leave the operator's seat:

- Lower the lift arms and put the attachment flat on the ground.
- Stop the engine.
- Engage the parking brake.
- Raise the seat bar.
- Move all controls to the NEUTRAL / LOCKED position to make sure the lift, tilt and traction drive functions are deactivated.

The seat bar system must deactivate these functions when the seat bar is up. See your Bobcat dealer for service if controls do not deactivate.

W-2463-1110

Disconnect attachment electrical harness and water or hydraulic lines, if applicable, from the loader. (See Relieve Auxiliary Hydraulic Pressure (Loader And Attachment) on Page 88.)

Figure 144

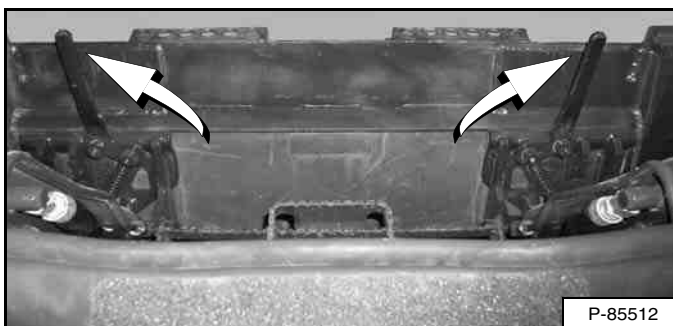

Pull the Bob-Tach levers up [Figure 144] until they are fully raised (wedges fully raised).

! WARNING

Bob-Tach levers have spring tension. Hold lever tightly and release slowly. Failure to obey warning can cause injury.

W-2054-1285

Enter the loader and perform the PRE-STARTING PROCEDURE. (See PRE-STARTING PROCEDURE on Page 92.)

Start the engine, press the PRESS TO OPERATE LOADER button, and release the parking brake.

Figure 145

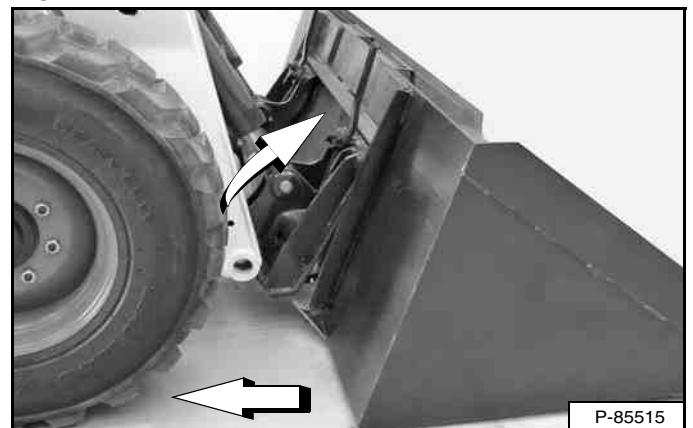

Tilt the Bob-Tach forward and drive the loader backward, away from the bucket or attachment [Figure 145].

ATTACHMENTS (CONT'D)

Installing And Removing The Attachment (Power Bob-Tach)

This machine may be equipped with a Power Bob-Tach.

The Power Bob-Tach is used for fast changing of buckets and attachments. See the appropriate attachment Operation & Maintenance Manual to install other attachments.

Installing

Enter the loader and perform the PRE-STARTING PROCEDURE. (See PRE-STARTING PROCEDURE on Page 92.)

Start the engine, press the PRESS TO OPERATE LOADER button, and release the parking brake.

Lower the lift arms and tilt the Bob-Tach forward.

Figure 146

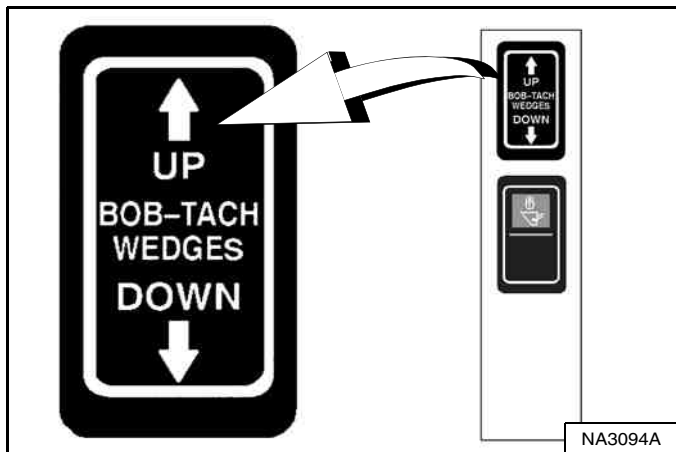
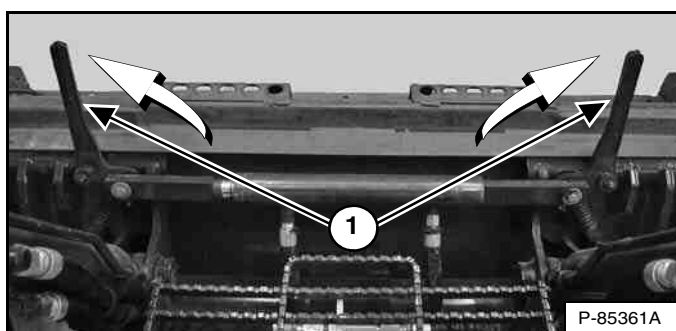

Figure 147



Push and hold BOB-TACH WEDGES “UP” switch (Right Switch Panel) [Figure 146] until levers (Item 1) [Figure 147] are fully raised (wedges fully raised).

Figure 148



Drive the loader slowly forward until the top edge of the Bob-Tach is completely under the top flange of the bucket mounting frame [Figure 148] (or other attachment).

NOTE: Be sure the Bob-Tach levers do not hit the attachment.

Figure 149



Tilt the Bob-Tach backward until the cutting edge of the bucket (or other attachment) is slightly off the ground [Figure 149]. This procedure will cause the bucket mounting frame to fit up against the front of the Bob-Tach.

ATTACHMENTS (CONT'D)

Installing And Removing The Attachment (Power Bob-Tach) (Cont'd)

Installing (Cont'd)

Figure 150

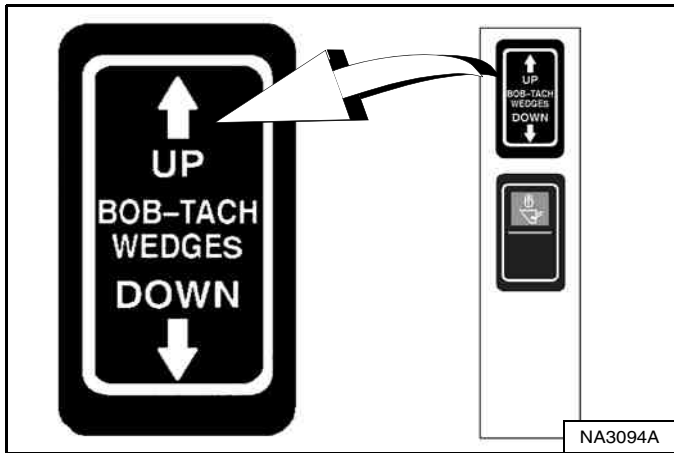

Push and hold BOB-TACH WEDGES “UP” switch (Right Switch Panel) [Figure 150] to make sure the levers are fully raised (wedges fully raised).

NOTE: The Power Bob-Tach system uses continuously pressurised hydraulic fluid to keep the wedges in the engaged position and prevent attachment disengagement. Because the wedges can slowly lower, the operator may need to reactivate the switch (BOB-TACH WEDGES “UP”) to be sure both wedges are fully raised before installing the attachment.

Figure 151

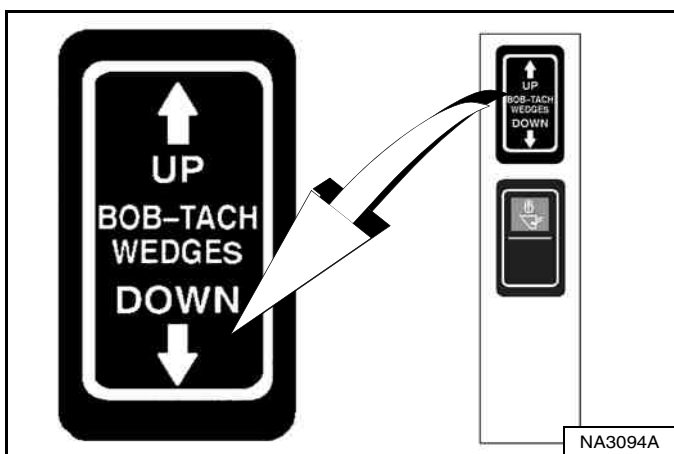
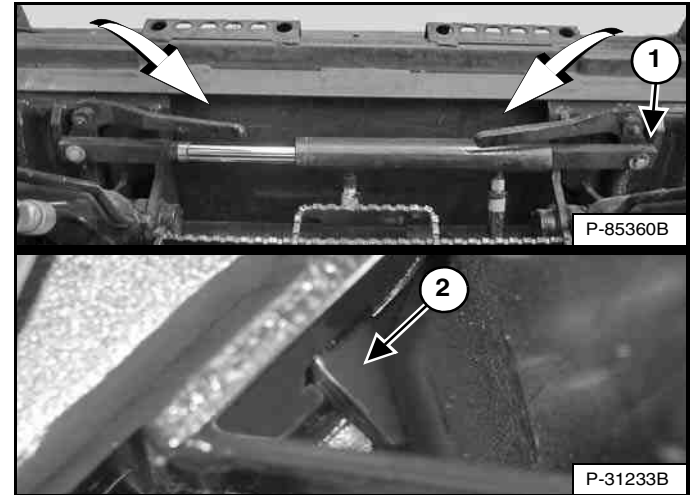

Figure 152



Push and hold BOB-TACH WEDGES “DOWN” switch (Right Switch Panel) [Figure 151] until levers are fully engaged in the locked position [Figure 152] (wedges fully extended through the attachment mounting frame holes).

Both levers must contact the frame as shown when locked (Item 1) [Figure 152].

If both levers do not engage in the locked position, see your Bobcat dealer for maintenance.

The wedges (Item 2) [Figure 152] must extend through the holes in the mounting frame of the bucket (or other attachment), securely fastening the bucket to the Bob-Tach.

! WARNING

AVOID INJURY OR DEATH

The Bob-Tach wedges must extend through the holes in the attachment mounting frame. Levers must be fully down and locked. Failure to secure wedges can allow attachment to come off.

W-2715-0208

ATTACHMENTS (CONT'D)

Installing And Removing The Attachment (Power Bob-Tach) (Cont'd)

Removing

Lower the lift arms and put the attachment flat on the ground. Lower or close any hydraulic equipment, if applicable.

If the attachment has electrical, water, or hydraulic connections to the loader:

1. Stop the engine and exit the loader. (See STOPPING THE ENGINE AND LEAVING THE LOADER on Page 104.)



AVOID INJURY OR DEATH

Before you leave the operator's seat:

- Lower the lift arms and put the attachment flat on the ground.
- Stop the engine.
- Engage the parking brake.
- Raise the seat bar.
- Move all controls to the NEUTRAL / LOCKED position to make sure the lift, tilt and traction drive functions are deactivated.

The seat bar system must deactivate these functions when the seat bar is up. See your Bobcat dealer for service if controls do not deactivate.

W-2463-1110

2. Disconnect attachment electrical harness and water or hydraulic lines, if applicable, from the loader. (See Relieve Auxiliary Hydraulic Pressure (Loader And Attachment) on Page 88.)
3. Enter the loader and perform the PRE-STARTING PROCEDURE. (See PRE-STARTING PROCEDURE on Page 92.)
4. Start the engine, press the PRESS TO OPERATE LOADER button, and release the parking brake.

Figure 153

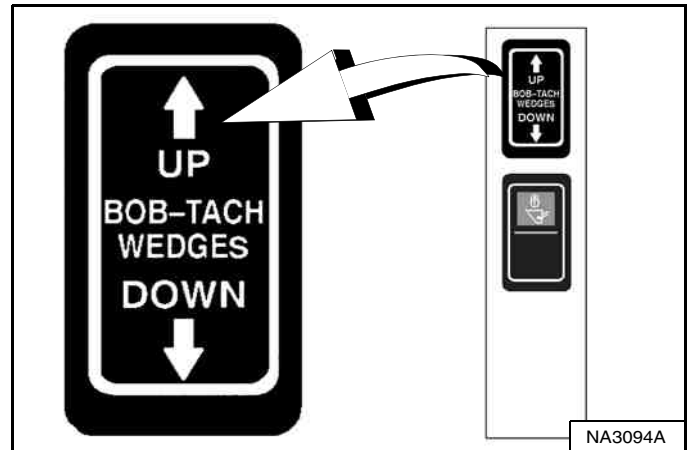

Push and hold BOB-TACH WEDGES "UP" switch (Right Switch Panel) [Figure 153] until levers are fully raised (wedges fully raised).

Figure 154

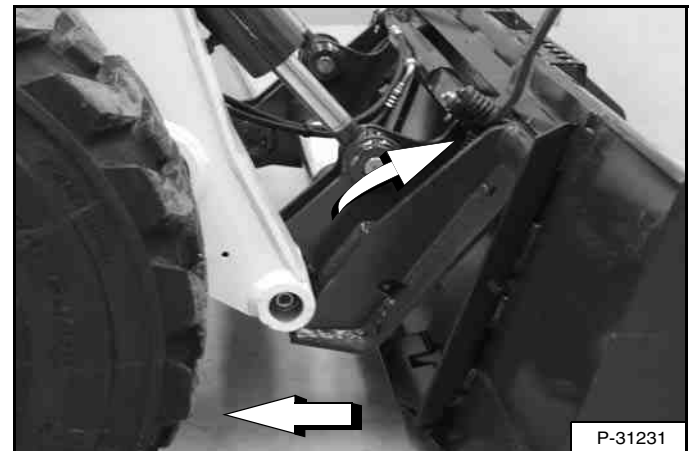

Tilt the Bob-Tach forward and drive the loader backward, away from the bucket or attachment [Figure 154].

NOTE: The Power Bob-Tach system uses continuously pressurised hydraulic fluid to keep the wedges in the engaged position and prevent attachment disengagement. Because the wedges can slowly lower, the operator may need to reactivate the switch (BOB-TACH WEDGES "UP") when removing an attachment to be sure both wedges are fully raised.



OPERATING PROCEDURE

Inspect The Work Area

Before beginning operation, inspect the work area for unsafe conditions.

Look for sharp drop-offs or rough terrain. Have underground utility lines (gas, electrical, water, sewer, irrigation, etc.) located and marked.

Remove objects or other construction material that could damage the loader or cause personal injury.

Always check ground conditions before starting your work:

- Inspect for signs of instability such as cracks or settlement.
- Be aware of weather conditions that can affect ground stability.
- Check for adequate traction if working on a slope.

Basic Operating Instructions

Always warm the engine and hydrostatic system before operating the loader.

IMPORTANT

Machines warmed up with moderate engine speed and light load have longer life.

I-2015-0284

Operate the loader with engine at full speed for maximum horsepower. Move the steering controls only a small amount to operate the loader slowly.

New operators must operate the loader in an open area without bystanders. Operate the controls until the loader can be handled at an efficient and safe rate for all conditions of the work area.

Operating Near An Edge Or Water

Keep the loader as far back from the edge as possible and the loader wheels perpendicular to the edge so that if part of the edge collapses, the loader can be moved back.

Always move the loader back at any indication the edge may be unstable.



MACHINE TIPPING OR ROLLOVER CAN CAUSE SERIOUS INJURY OR DEATH

- **Keep the lift arms as low as possible.**
- **Do not travel or turn with the lift arms up.**
- **Turn on level ground. Slow down when turning.**
- **Go up and down slopes, not across them.**
- **Keep the heavy end of the machine uphill.**
- **Do not overload the machine.**
- **Check for adequate traction.**

W-2018-1112

Driving On Public Roads

When operating on a public road or motorway, always follow local regulations. For example: Slow Moving Vehicle Sign or direction signals may be required.

NOTE: Road kits are available as an option from the factory or as a kit from your Bobcat dealer to equip your machine for driving on public roads in European Union (EU) countries.

Always follow local regulations. For more information, contact your local Bobcat dealer.

OPERATING PROCEDURE (CONT'D)

Operating With A Full Bucket

Figure 155

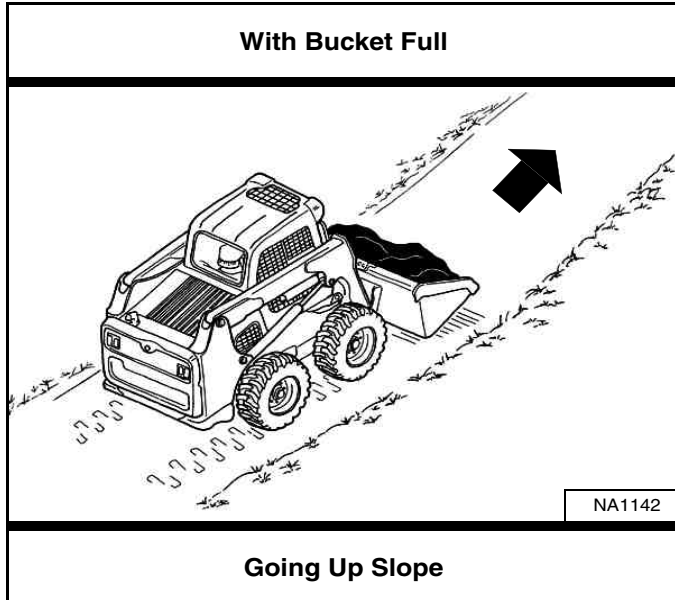

Operating With An Empty Bucket

Figure 157

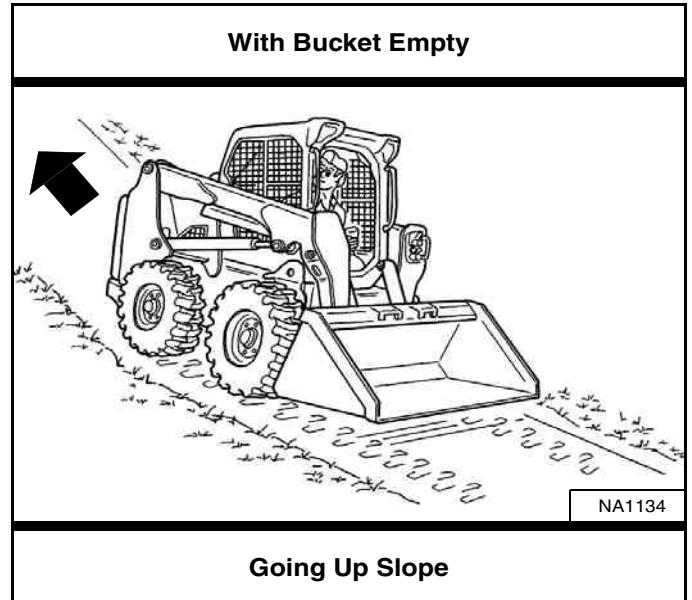

Figure 156

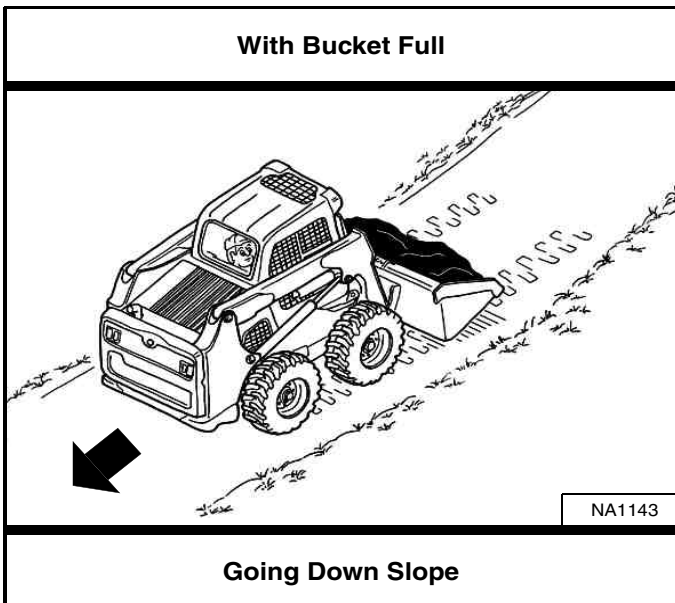
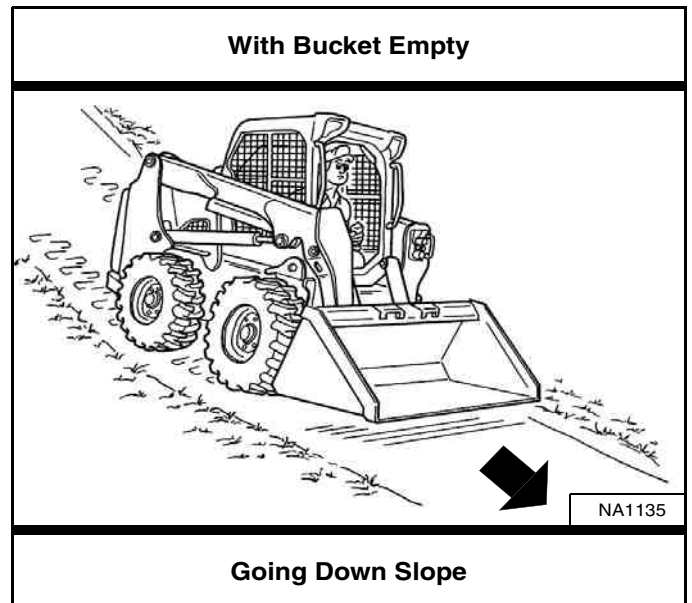

Figure 158



With a full bucket, go up or down the slope with the heavy end toward the top of the slope [Figure 155] and [Figure 156].

With an empty bucket, go up or down the slope with the heavy end toward the top of the slope [Figure 157] and [Figure 158].

Raise the bucket only high enough to avoid obstructions on rough ground.

Raise the bucket only high enough to avoid obstructions on rough ground.

TOWING THE LOADER

Procedure

Because of the design of the loader, there is not a recommended towing procedure.

- The loader can be lifted onto a transport vehicle.
- The loader can be skidded a short distance to move for service (EXAMPLE: Move onto a transport vehicle.) without damage to the hydrostatic system. (The tyres will not turn.) There may be slight wear to the tyres when the loader is skidded.

The towing chain (or cable) must be rated at 1.5 times the weight of the loader. (See Performance on Page 201.)

LIFTING THE LOADER

Single-Point Lift

! WARNING

AVOID INJURY OR DEATH

- Before lifting, check fasteners on single point lift and operator cab.
- Assemble front cab fasteners as shown in this manual.
- Never allow riders in the cab or bystanders within 5 m (15 ft) while lifting the machine.

W-2007-0910

The loader can be lifted with the Single-Point Lift that is available as a kit from your Bobcat loader dealer.

The Single-Point Lift, supplied by Bobcat, is designed to lift and support the Bobcat loader without affecting rollover and falling object protection features of the operator cab.

Figure 159

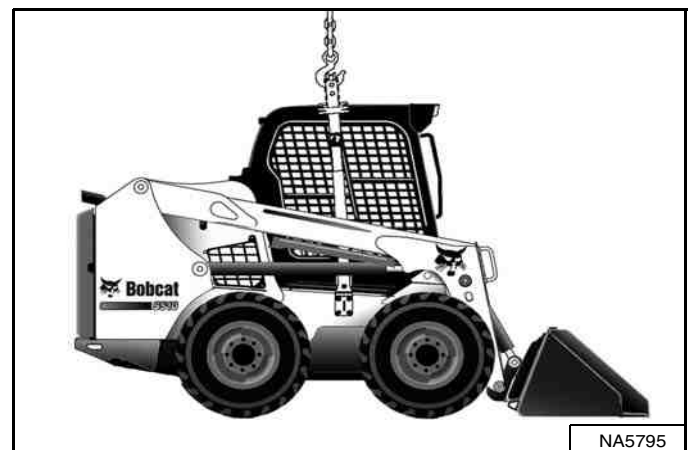

Attach lift to lift eye [Figure 159].

NOTE: Be sure the lifting equipment is of adequate size and capacity for the weight of the loader. (See Performance on Page 201.)

LIFTING THE LOADER (CONT'D)

Four-Point Lift



AVOID INJURY OR DEATH

- Before lifting, check fasteners on four point lift.
- Never allow riders in the cab or bystanders within 5 m (15 ft) while lifting the machine.

W-2160-0910

The loader can be lifted with the Four-Point Lift that is available as a kit from your Bobcat loader dealer.

Figure 160

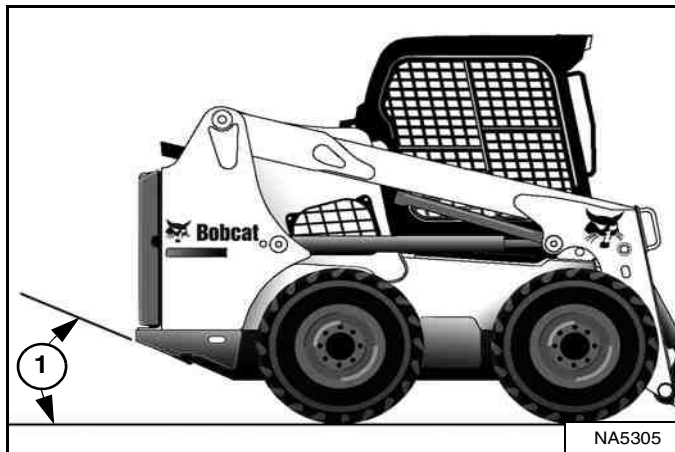

NOTE: The loader should be lifted as close to horizontal as possible, but at no time should the angle of the suspended loader exceed the departure angle (Item 1) [Figure 160] provided in the specifications section. (See Machine Dimensions on Page 200.)

Figure 161

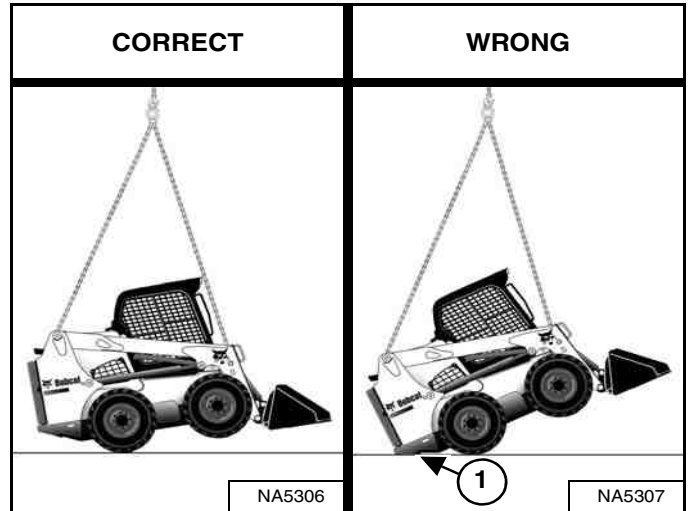

Attach cables or chains to lift eyes [Figure 161].

NOTE: Sling legs should not contact any part of the operator cab or lift arms to prevent damage.

NOTE: The required length of front and rear sling legs may or may not be equal depending on loader configuration. Departure angle (Item 1) [Figure 161] in this view has been exceeded, sling leg length must be adjusted to prevent this situation.

NOTE: Be sure the lifting equipment is of adequate size and capacity for the weight of the loader. (See Performance on Page 201.)

TRANSPORTING THE LOADER ON A TRAILER

Loading And Unloading



AVOID SERIOUS INJURY OR DEATH

Adequately designed ramps of sufficient strength are needed to support the weight of the machine when loading onto a transport vehicle. Wood ramps can break and cause personal injury.

W-2058-0807

Be sure the transport and towing vehicles are of adequate size and capacity for weight of loader. (See Performance on Page 201.)

Figure 162



A loader with an empty bucket or no attachment must be loaded backward onto the transport vehicle [Figure 162].

The rear of the trailer must be blocked or supported (Item 1) [Figure 162] when loading or unloading the loader to prevent the front end of the trailer from raising up.

Fastening

Figure 163

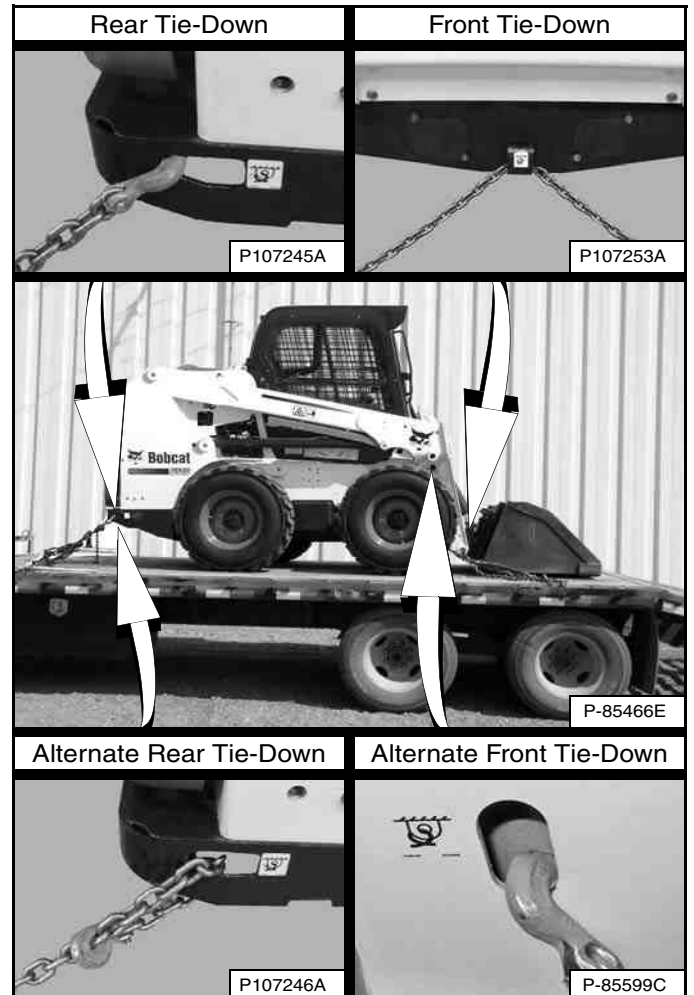

Use the following procedure to fasten the Bobcat loader to the transport vehicle to prevent the loader from moving during sudden stops, or when going up or down slopes [Figure 163].

1. Lower the bucket or attachment to the floor.
2. Stop the engine.
3. Engage the parking brake.
4. Install chains at the front and rear loader tie-down positions [Figure 163]. (Lift arms shown raised for visual clarity.)
5. Fasten each end of the chain to the transport vehicle.
6. Use chain binders to tighten the chains.



PREVENTIVE MAINTENANCE

MAINTENANCE SAFETY	121
SERVICE SCHEDULE	122
Maintenance Intervals	122
Inspection Checkbook	124
BOBCAT INTERLOCK CONTROL SYSTEM (BICS™)	125
Inspecting The BICS™ (Engine STOPPED - Key ON)	125
Inspecting Deactivation Of The Auxiliary Hydraulics System (Engine STOPPED - Key ON)	125
Inspecting The Seat Bar Sensor (Engine RUNNING)	125
Inspecting The Traction Lock And Parking Brake (Engine RUNNING)	125
Inspecting The Lift Arm Bypass Control	125
Inspecting Deactivation Of Lift And Tilt Functions (ACS, AHC, And SJC)	125
SEAT BAR RESTRAINT SYSTEM	126
Description	126
Inspection And Maintenance	127
SEAT BELT	128
Inspection And Maintenance	128
LIFT ARM SUPPORT DEVICE	129
Description	129
Installing	130
Removing	131
BACK-UP ALARM SYSTEM	132
Description	132
Inspection	132
Adjusting Switch Position	133
OPERATOR CAB	134
Description	134
Cab Door Sensor	134
Raising	135
Lowering	136
REAR DOOR (TAILGATE)	137
Opening And Closing	137
Adjusting Latch	137
REAR GRILLE	138
Removing	138
Installing	138
HEATING SYSTEM	139
Filters	139
Heater Coil	140
Troubleshooting	140



ENGINE AIR CLEANER	141
Replacing Filters	141
FUEL SYSTEM	143
Fuel Specifications	143
Biodiesel Blend Fuel	143
Filling The Fuel Tank	144
Fuel Filter	145
Removing Air From The Fuel System	146
ENGINE LUBRICATION SYSTEM	147
Checking And Adding Engine Oil	147
Engine Oil Chart	147
Removing And Replacing Oil And Filter	148
ENGINE COOLING SYSTEM	149
Maintenance Platform	149
Cooling System Identification	149
Cleaning (Earlier Models)	150
Cleaning (Later Models)	151
Checking And Adding Coolant	152
Removing And Replacing Coolant	153
ELECTRICAL SYSTEM	154
Description	154
Fuse And Relay Location / Identification	154
Battery Maintenance	158
Maintaining Battery Charge Level	158
Battery Service During Machine Storage	158
Battery Testing	159
Battery Charging	159
Using A Booster Battery (Jump Starting)	160
Removing And Installing Battery	161
HYDRAULIC / HYDROSTATIC SYSTEM	162
Checking And Adding Fluid	162
Hydraulic / Hydrostatic Fluid Chart	162
Removing And Replacing Hydraulic Fluid	163
Removing And Replacing Hydraulic / Hydrostatic Filter	165
Removing And Replacing Hydraulic Charge Filter	166
Replacing Reservoir Breather Cap	168
SPARK ARRESTER MUFFLER	169
Cleaning Procedure	169
TYRE MAINTENANCE	170
Wheel Nuts	170
Rotating	170
Mounting	170
FINAL DRIVE TRANSMISSION (CHAINCASE)	171
Checking And Adding Fluid	171
Removing And Replacing Fluid	171



ALTERNATOR BELT	172
Belt Adjustment	172
Belt Replacement	172
DRIVE BELT	173
Belt Adjustment	173
Belt Replacement	174
AUTOMATIC RIDE CONTROL ACCUMULATOR	176
Checking Accumulator Charge	176
LUBRICATING THE LOADER	177
Lubrication Locations	177
PIVOT PINS	179
Inspection And Maintenance	179
BOB-TACH (HAND LEVER)	180
Inspection And Maintenance	180
BOB-TACH (POWER)	181
Inspection And Maintenance	181
LOADER STORAGE AND RETURN TO SERVICE	182
Storage	182
Return To Service	182

MAINTENANCE SAFETY

WARNING

Instructions are necessary before operating or servicing machine. Read and understand the Operation & Maintenance Manual, Operator's Handbook and signs (decals) on machine. Follow warnings and instructions in the manuals when making repairs, adjustments or servicing. Check for correct function after adjustments, repairs or service. Untrained operators and failure to follow instructions can cause injury or death.

W-2003-0807

Safety Alert Symbol: This symbol with a warning statement, means: "Warning, be alert! Your safety is involved!" Carefully read the message that follows.

CORRECT

P-90216

Never service the Bobcat Skid-Steer Loader without instructions.

CORRECT

NA1204

Use the correct procedure to lift or lower operator cab.

CORRECT

NA1193

Cleaning and maintenance are required daily.

WRONG

NA1192

- Have good ventilation when welding or grinding painted parts.**
- Wear dust mask when grinding painted parts. Toxic dust and gas can be produced.**
- Avoid exhaust fume leaks which can kill without warning. Exhaust system must be tightly sealed.**

WRONG

NA1205

Disconnecting or loosening any hydraulic tubeline, hose, fitting, component or a part failure can cause lift arms to drop. Do not go under lift arms when raised unless supported by an approved lift arm support device. Replace it if damaged.

WRONG

NA1206

- Never work on loader with lift arms up unless lift arms are held by an approved lift arm support device. Replace if damaged.**
- Never modify equipment or add attachments not approved by Bobcat Company.**

WRONG

NA1200

- Stop, cool and clean engine of flammable materials before checking fluids.**
- Never service or adjust loader with the engine running unless instructed to do so in the manual.**
- Avoid contact with leaking hydraulic fluid or diesel fuel under pressure. It can penetrate the skin or eyes.**
- Never fill fuel tank with engine running, while smoking or when near open flame.**

WRONG

NA1191

- Keep body, jewelry and clothing away from moving parts, electrical contact, hot parts and exhaust.**
- Wear eye protection to guard from battery acid, compressed springs, fluids under pressure and flying debris when engines are running or tools are used. Use eye protection approved for type of welding.**
- Keep rear door closed except for service. Close and latch door before operating the loader.**

WRONG

B-6589

- Lead-acid batteries produce flammable and explosive gases.**
- Keep arcs, sparks, flames and lighted tobacco away from batteries.**
- Batteries contain acid which burns eyes or skin on contact.**
- Wear protective clothing. If acid contacts body, flush well with water. For eye contact flush well and get immediate medical attention.**

Maintenance procedures which are given in the Operation & Maintenance Manual can be performed by the owner/operator without any specific technical training. Maintenance procedures which are **not** in the Operation & Maintenance Manual must be performed **ONLY BY QUALIFIED BOBCAT SERVICE PERSONNEL**. Always use genuine Bobcat replacement parts. The Service Safety Training Course is available from your Bobcat dealer.

MSW35-0409



SERVICE SCHEDULE

Maintenance Intervals

Maintenance work must be done at regular intervals. Failure to do so will result in excessive wear and early failures.

The service schedule is a guide for correct maintenance of the Bobcat loader.

WARNING

AVOID INJURY OR DEATH

Instructions are necessary before operating or servicing machine. Read and understand the Operation & Maintenance Manual, Operator's Handbook and signs (decals) on machine. Follow warnings and instructions in the manuals when making repairs, adjustments or servicing. Check for correct function after adjustments, repairs or service. Untrained operators and failure to follow instructions can cause injury or death.

W-2003-0807

Every 10 Hours (Before Starting The Loader)

- **Engine Oil** - Check level and add as needed. (See Page 147.)
- **Engine Air Filters and Air System** - Check display panel. Service only when required. Check for leaks and damaged components. (See Page 141.)
- **Engine Cooling System** - Clean debris from radiator, hydraulic fluid cooler, and rear grille. Check coolant level COLD and add premixed coolant as needed. (See Page 150.) or (See Page 151.) and (See Page 152.)
- **Fuel Filter** - Remove the trapped water. (See Page 145.)
- **Lift Arms, Lift Links, Cylinders, Bob-Tach, Pivot Pins, Wedges** - Lubricate with multipurpose lithium based grease. (See Page 177.)
- **Seat Belt, Seat Belt Retractors, Seat Bar, Control Interlocks** - Check the condition of seat belt. Clean or replace seat belt retractors as needed. Check the seat bar and control interlocks for correct operation. Clean dirt and debris from moving parts. (See Page 126.) and (See Page 128.)
- **Bobcat Interlock Control Systems (BICS™)** - Check for correct function. Lift and Tilt functions MUST NOT operate with seat bar raised. (See Page 125.)
- **Front Horn** - Check for proper function. (See Page 51.)
- **Tyres** - Check for damaged tyres and correct air pressure. Inflate to MAXIMUM pressure shown on the sidewall of the tyre. (See Page 170.)
- **Operator Cab** - Check the fastening bolts, washers, and nuts. Check the condition of the cab. (See Page 134.)
- **Indicators and Lights** - Check for correct operation of all indicators and lights. (See Page 38.)
- **Wheel Nuts** - Perform every 10 hours or daily for the first 30 hours, then as scheduled. Check for loose wheel nuts and tighten to correct torque. (See Page 170.)
- **Safety Signs and Safety Treads** - Check for damaged signs (decals) and safety treads. Replace any signs or safety treads that are damaged or worn. (See Page 19.) and (See Page 92.)
- **Hydraulic Fluid** - Check fluid level and add as needed. (See Page 162.)
- **Heater Filters** (if equipped) - Clean or replace filters as needed. (See Page 139.)



SERVICE SCHEDULE (CONT'D)

Maintenance Intervals (Cont'd)

Every 50 Hours

- **Hydraulic Hoses and Tubelines** - Check for damage and leaks. Repair or replace as needed.
- **Final Drive Transmission (Chaincase)** - Check fluid level and add as needed. (See Page 171.)
- **Parking Brake, Foot Pedals, Hand Controls and Steering Levers, or Joysticks** - Check for correct operation. Repair or adjust as needed.
- **Wheel Nuts** - Check for loose wheel nuts and tighten to correct torque. (See Page 170.)
- **Engine / Hydrostatic Drive Belt** - Perform at first 50 hours, then as scheduled. Check for wear or damage. Adjust or replace as needed. (See Page 173.)
- **Engine Oil and Filter** - Perform at first 50 hours, then as scheduled. Replace oil and filter. (See Page 148.)

Every 100 Hours

- **Spark Arrester** - Empty spark chamber. (See Page 169.)
- **Battery** - Check cables and connections. (See Page 158.)
- **Engine Oil and Filter** - Perform every 100 hours when operating under severe conditions. Replace oil and filter. (See Page 148.)

Every 250 Hours or Every 12 Months

- **Fuel Filter** - Replace filter. (See Page 145.)
- **Engine / Hydrostatic Drive Belt** - Check for wear or damage. Adjust or replace as needed. (See Page 173.)
- **Drive Belt (Alternator, water pump)** - Check condition. Replace as needed. (See Page 172.)
- **Bobcat Interlock Control System (BICS™)** - Check the function of the lift arm bypass control. (See Page 125.)
- **Engine Oil and Filter** - Replace oil and filter. (See Page 148.)

Every 500 Hours or Every 12 Months

- **Hydraulic Charge Filter, Hydraulic Reservoir Breather Cap** - Replace the charge filter and the reservoir breather cap. (See Page 166.) and (See Page 168.)

Every 1000 Hours or Every 12 Months

- **Hydraulic / Hydrostatic Filter** - Replace the hydraulic / hydrostatic filter. (See Page 165.)
- **Hydraulic Reservoir** - Replace the fluid. (See Page 163.)
- **Final Drive Transmission (Chaincase)** - Replace the fluid. (See Page 171.)
- **Engine Valves** - Adjust the engine valve clearance.

Every 24 Months

- **Coolant** - Replace the coolant. (See Page 153.)

NOTE: The Inspection Checkbook can be ordered for you by your local dealer. Part number 7296478.



SERVICE SCHEDULE (CONT'D)

Inspection Checkbook

Maintenance work must be done at regular intervals. Failure to do so will result in excessive wear and early failures.

The service schedule is a guide for correct maintenance of the Bobcat loader.

The Inspection Checkbook contains the following information:

- Doosan Bobcat EMEA s.r.o. Warranty Policy
- Doosan Bobcat EMEA s.r.o. Extended Warranty Policy

The Inspection Checkbook has to be filled in by the Dealer for any maintenance and service work of your Bobcat machine. This book may be required anytime by an authorised dealer or by Bobcat Europe, should a breakdown occur on the Bobcat equipment.

Your local dealer can order the Inspection Checkbook. Part number: 7296478.

BOBCAT INTERLOCK CONTROL SYSTEM (BICS™)

See the SERVICE SCHEDULE for the correct service interval. (See SERVICE SCHEDULE on Page 122.)

Inspecting The BICS™ (Engine STOPPED - Key ON)

Figure 164

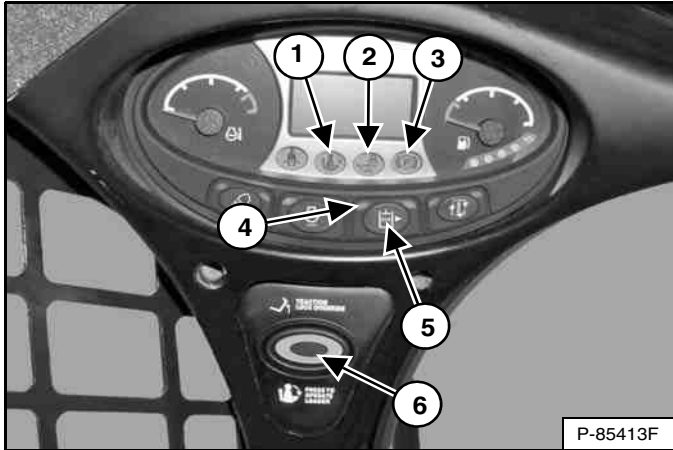

1. Sit in operator's seat. Turn key switch to RUN. Lower seat bar and disengage parking brake. Press the PRESS TO OPERATE LOADER button (Item 6). Two BICS™ lights (Items 1 and 2) [Figure 164] [SEAT BAR and LIFT AND TILT VALVE] on left instrument panel must be OFF. The PRESS TO OPERATE LOADER button will light.
2. Raise seat bar fully. All three BICS™ lights (Items 1, 2, and 3) [Figure 164] [SEAT BAR, LIFT AND TILT VALVE, and PARKING BRAKE] on left instrument panel must be ON. The PRESS TO OPERATE LOADER button light will turn OFF.

Inspecting Deactivation Of The Auxiliary Hydraulics System (Engine STOPPED - Key ON)

3. Sit in operator's seat, lower seat bar, and press the PRESS TO OPERATE LOADER button (Item 6). Press the Auxiliary Hydraulics button (Item 5). The auxiliary hydraulics light will turn ON (Item 4) [Figure 164]. Raise the seat bar. The light will turn OFF.

Inspecting The Seat Bar Sensor (Engine RUNNING)

4. Sit in operator's seat, lower seat bar, engage parking brake, and fasten seat belt.
5. Start engine and operate at low idle. Press the PRESS TO OPERATE LOADER button. While raising the lift arms, raise the seat bar fully. The lift arms must stop. Repeat using the tilt function.

Inspecting The Traction Lock And Parking Brake (Engine RUNNING)

6. Fasten seat belt, disengage parking brake, press the PRESS TO OPERATE LOADER button, and raise seat bar fully. Move steering levers or joystick(s) slowly forward and backward. The TRACTION lock must be engaged. Lower the seat bar. Press the PRESS TO OPERATE LOADER button.
7. Engage parking brake and move steering levers or joystick(s) slowly forward and backward. The TRACTION lock must be engaged. See your Bobcat dealer for service if loader fails to stop.

NOTE: The PARKING BRAKE light on the left instrument panel will remain ON until the engine is started, the PRESS TO OPERATE LOADER button is pressed, and the parking brake is disengaged.

Inspecting The Lift Arm Bypass Control

8. Raise the lift arms 2 m (6 ft) off the ground. Stop engine. Turn lift arm bypass control knob 90° clockwise. Pull up and hold lift arm bypass control knob until lift arms slowly lower.

Inspecting Deactivation Of Lift And Tilt Functions (ACS, AHC, And SJC)

9. Sit in operator's seat and fasten seat belt. Lower seat bar, start engine, and press the PRESS TO OPERATE LOADER button.
10. Raise lift arms approximately 2 m (6 ft) off the ground.
11. Turn key switch to STOP and wait for the engine to come to a complete stop.
12. Turn key switch to RUN. Press the PRESS TO OPERATE LOADER button, move the control (foot pedal, hand control, or joystick) to lower the lift arms. Lift arms must not lower.
13. Move the control (foot pedal, hand control, or joystick) to tilt the bucket (or attachment) forward. The bucket (or attachment) must not tilt forward.

WARNING

AVOID INJURY OR DEATH

The Bobcat Interlock Control System (BICS™) must deactivate the lift, tilt and traction drive functions. If it does not, contact your dealer for service. DO NOT modify the system.

W-2151-1111

SEAT BAR RESTRAINT SYSTEM

Description

Figure 165

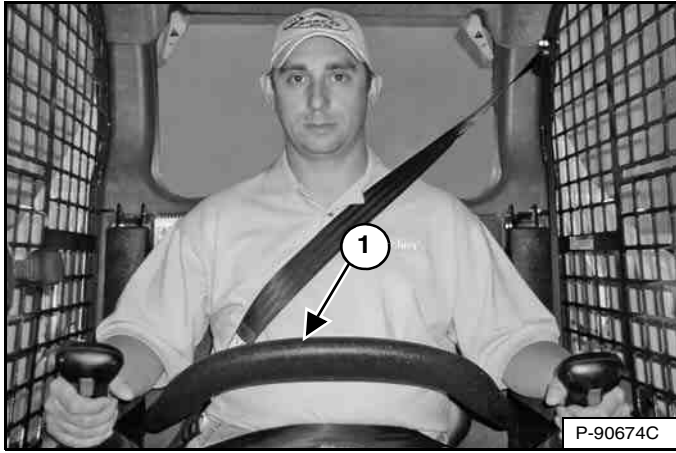

The seat bar restraint system has a pivoting seat bar with armrests (Item 1) [Figure 165].

The operator controls the use of the seat bar. The seat bar in the down position helps to keep the operator in the seat.

Models with Standard Controls have hydraulic valve spool interlocks for the lift and tilt functions. The spool interlocks require the operator to lower the seat bar in order to operate the foot pedal controls.

When the seat bar is down, the engine is running, the PRESS TO OPERATE LOADER button is activated, and the brake is released; the lift, tilt, and traction drive functions can be operated.

When the seat bar is up, the lift and tilt control pedals are locked when returned to the NEUTRAL position.

Models with Advanced Control System (ACS) have mechanical interlocks for the handles and pedals. The interlocks for the handles and pedals require the operator to lower the seat bar in order to operate the selected controls.

When the seat bar is down, the engine is running, the PRESS TO OPERATE LOADER button is activated, and the brake is released; the lift, tilt, and traction drive functions can be operated.

When the seat bar is up, the handles and pedals are locked when returned to the NEUTRAL position.

Models with Advanced Hand Controls (AHC) have mechanical interlocks for the handles. The interlocks for the handles require the operator to lower the seat bar in order to operate the controls.

When the seat bar is down, the PRESS TO OPERATE LOADER button is activated and the engine is running, the lift, tilt and traction drive functions can be operated using the handles.

When the seat bar is up, the handles are locked when returned to the NEUTRAL position.

Models with Selectable Joystick Controls (SJC) have electrical deactivation of lift and tilt functions. Activation of functions require the operator to lower the seat bar.

When the seat bar is down, the engine is running, the PRESS TO OPERATE LOADER button is activated, and the brake is released; the lift, tilt, and traction drive functions can be operated.

When the seat bar is up, the lift and tilt functions are deactivated even though the joysticks do not mechanically lock.

SEAT BAR RESTRAINT SYSTEM (CONT'D)

Inspection And Maintenance

See the SERVICE SCHEDULE for the correct service interval. (See SERVICE SCHEDULE on Page 122.)

Sit in the seat and fasten the seat belt. Engage the parking brake. Pull the seat bar all the way down. Start the engine. Press the PRESS TO OPERATE LOADER button.

Operate the hydraulic controls to check that the lift and tilt functions operate correctly. Raise the lift arms until the attachment is approximately 600 mm (2 ft) off the ground.

Raise the seat bar. Move the hydraulic controls. Pedals and handles (if equipped) must be firmly locked in the NEUTRAL position (except joysticks). There must be no motion of the lift arms or tilt (attachment) when the controls are moved.

Lower the seat bar, press the PRESS TO OPERATE LOADER button, and lower the lift arms. Operate the lift control. While the lift arms are going up, raise the seat bar. The lift arms must stop.

Lower the seat bar, press the PRESS TO OPERATE LOADER button, lower the lift arms, and put the attachment flat on the ground. Stop the engine. Raise the seat bar. Operate the foot pedals and handles (if equipped) to be sure they are firmly locked in the NEUTRAL position (except joysticks).

Figure 166

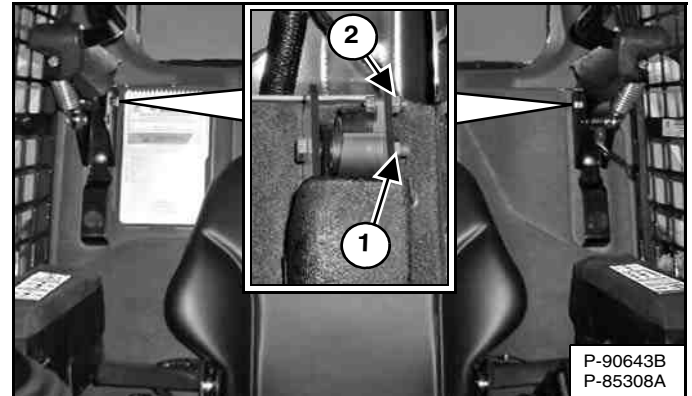

Use compressed air to clean any debris or dirt from the pivot parts. Do not lubricate. Inspect all mounting hardware. The correct hinge nut (both sides) (Item 1) torque is 34 - 38 N•m (25 - 28 ft-lb). The seat bar sensor nut (left side only) (Item 2) [Figure 166] torque is 6 - 8 N•m (50 - 70 in-lb).

If the seat bar system does not function correctly, replace parts that are worn or damaged. Use only genuine Bobcat replacement parts.

WARNING

The seat bar system must deactivate the lift and tilt control functions when the seat bar is up. See your Bobcat dealer for service if hydraulic controls do not deactivate.

W-2465-0111

SEAT BELT

Inspection And Maintenance

! WARNING

Failure to properly inspect and maintain the seat belt can cause lack of operator restraint resulting in serious injury or death.

W-2466-0703

Check the seat belt daily for correct function.

Inspect the seat belt system thoroughly at least once each year, or more often if the machine is exposed to severe environmental conditions or applications.

Any seat belt system that shows cuts, fraying, extreme or unusual wear, significant discolourations due to ultraviolet UV exposure, dusty / dirty conditions, abrasion to the seat belt webbing, or damage to the buckle, latch plate, retractor (if equipped), hardware, or any other obvious problem should be replaced immediately.

The items below are referenced in [Figure 167].

1. Check the webbing. If the system is equipped with a retractor, pull the webbing completely out and inspect the full length of the webbing. Look for cuts, wear, fraying, dirt, and stiffness.
2. Check the buckle and latch for correct operation. Make sure latch plate is not excessively worn or deformed and buckle is not damaged or casing broken.
3. Check the retractor web storage device (if equipped) by extending webbing to determine if it looks correct, and that it spools out and retracts webbing correctly.
4. Check webbing in areas exposed to ultraviolet (UV) rays from the sun, or extreme dust or dirt. If the original colour of the webbing in these areas is extremely faded and / or the webbing is packed with dirt, the webbing strength may have deteriorated.
5. Check the hardware on both sides of the seat. Hardware should be tight. Hardware must not be missing, rusted, corroded, or damaged.

See your Bobcat dealer for seat belt system replacement parts for your machine.

Figure 167

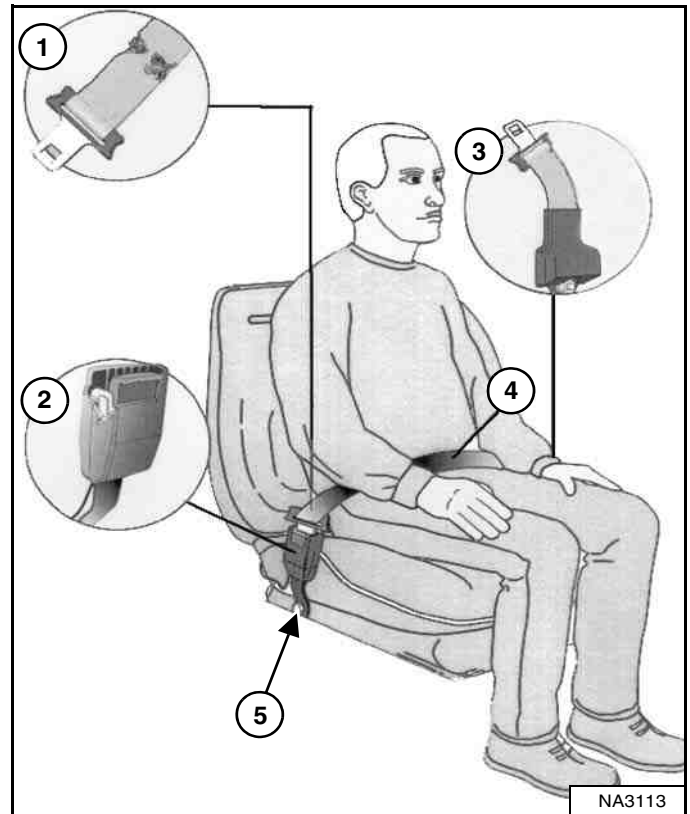

LIFT ARM SUPPORT DEVICE

Description



Never work on a machine with the lift arms up unless the lift arms are secured by an approved lift arm support device. Failure to use an approved lift arm support device can allow the lift arms or attachment to fall and cause injury or death.

Service lift arm support device if damaged or if parts are missing. Using a damaged lift arm support or with missing parts can cause lift arms to drop causing injury or death.

W-2572-0407

Figure 168

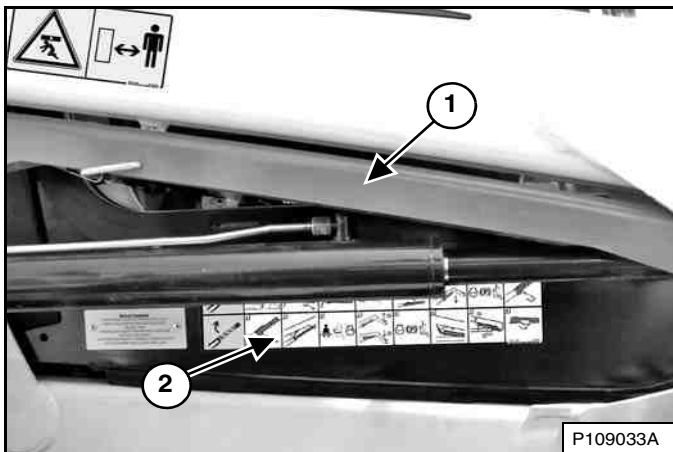

The lift arm support device (Item 1) [Figure 168] is used to support the lift arms while working on a machine with the lift arms up.

A decal (Item 2) [Figure 168] located on the right side of the operator cab provides instructions for installing and removing the lift arm support device.

The procedures are described in more detail on the following pages. (See Installing on Page 130.) and (See Removing on Page 131.)

LIFT ARM SUPPORT DEVICE (CONT'D)

Installing

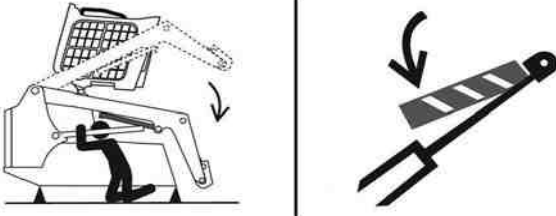

P-90328

AVOID DEATH

- Disconnecting or loosening any hydraulic tubeline, hose, fitting, component or a part failure can cause lift arms to drop.
- Keep out of this area when lift arms are raised unless supported by an approved lift arm support. Replace if damaged.

D-1009-0409

Remove attachment from the loader. (See Installing And Removing The Attachment (Hand Lever Bob-Tach) on Page 107.) **OR** (See Installing And Removing The Attachment (Power Bob-Tach) on Page 110.)

Figure 169

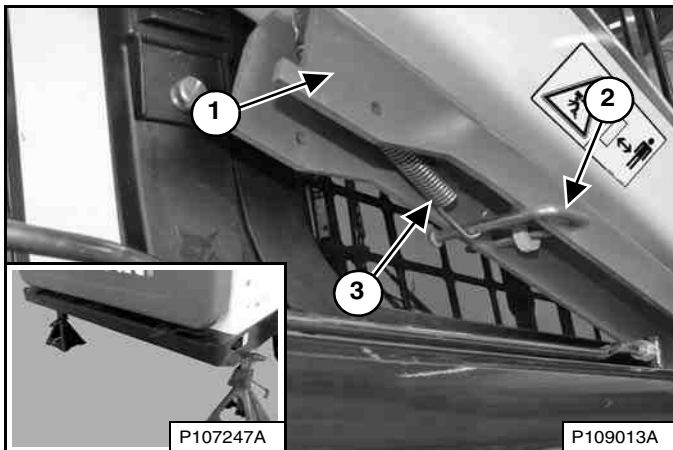

Put jackstands under the rear corners of the loader frame (Inset) [Figure 169].

Disconnect the spring (Item 3) from the lift arm support device retaining pin (Item 2). Support the lift arm support device (Item 1) with your hand and remove the retaining pin [Figure 169].

Figure 170

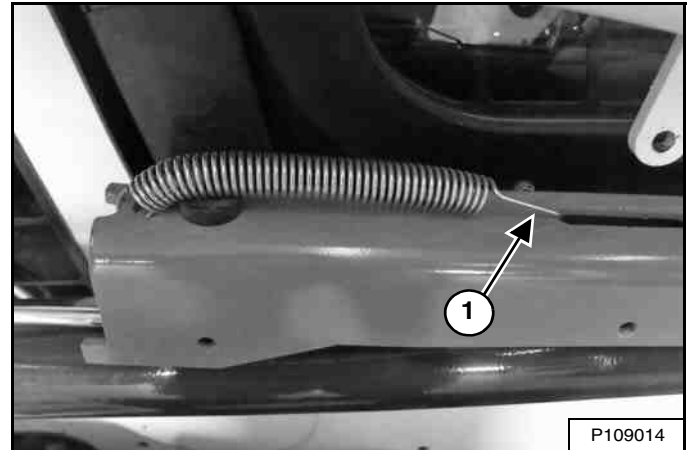

Lower the lift arm support device to the top of the lift cylinder. Hook the free end of the spring (Item 1) [Figure 170] to the lift arm support device to prevent interference with lift arm support device engagement.

Sit in the operator's seat, fasten the seat belt, and lower the seat bar. Start the engine.

Figure 171

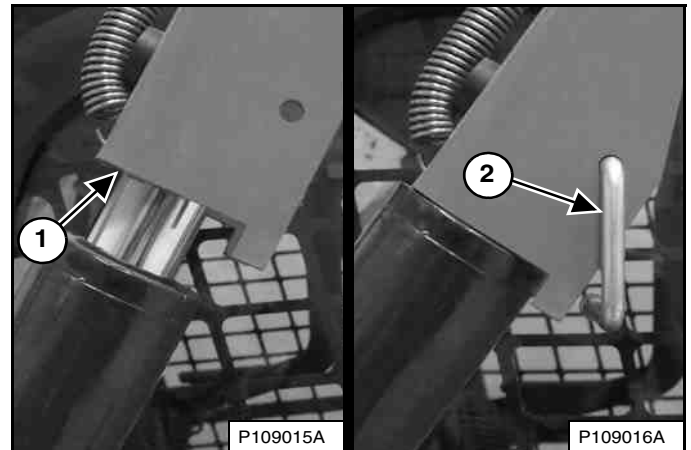

Raise the lift arms until the lift arm support device drops onto the lift cylinder rod (Item 1) [Figure 171].

Lower the lift arms slowly until the lift arm support device is held between the lift arm and the lift cylinder.

Stop the engine, raise the seat bar, unbuckle the seat belt, and make sure lift and tilt functions are deactivated.

Install the retaining pin (Item 2) [Figure 171] into the rear of the lift arm support device below the lift cylinder rod.

LIFT ARM SUPPORT DEVICE (CONT'D)

Removing

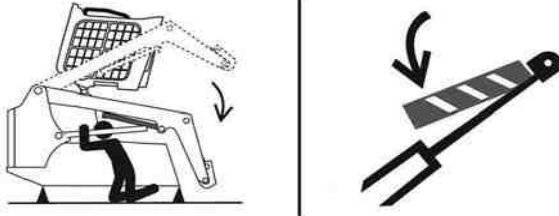

P-90328

AVOID DEATH

- Disconnecting or loosening any hydraulic tubeline, hose, fitting, component or a part failure can cause lift arms to drop.
- Keep out of this area when lift arms are raised unless supported by an approved lift arm support. Replace if damaged.

D-1009-0409

Figure 172

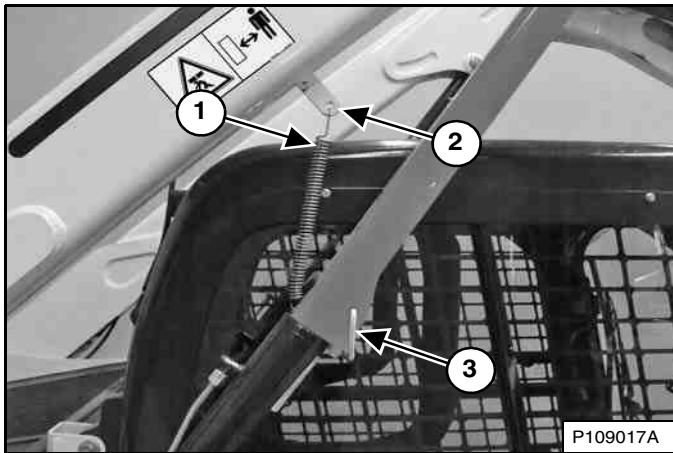

P109017A

Remove the retaining pin (Item 3) [Figure 172] from the lift arm support device.

Connect the spring (Item 1) from the lift arm support device to the bracket (Item 2) [Figure 172] on the bottom of the lift arm.

Sit in the operator's seat, fasten the seat belt, and lower the seat bar. Start the engine.

Figure 173

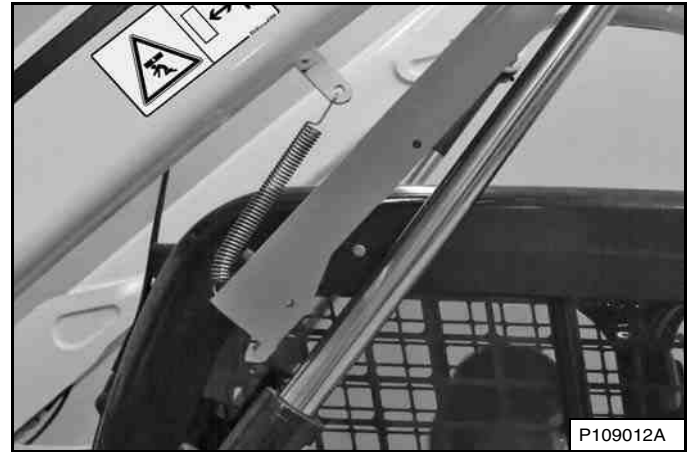

P109012A

Raise the lift arms a small amount. The spring will lift the lift arm support device off the lift cylinder rod [Figure 173]. Fully lower the lift arms.

Stop the engine, raise the seat bar, unbuckle the seat belt, and make sure lift and tilt functions are deactivated.

Disconnect the spring from the bracket.

Figure 174

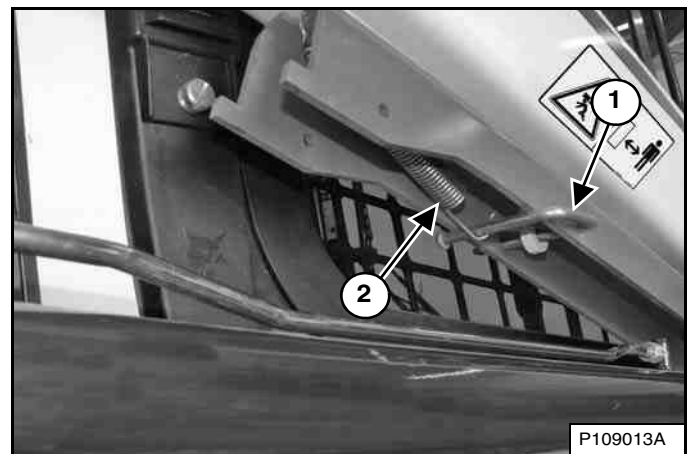

P109013A

Raise the lift arm support device into storage position and insert the retaining pin (Item 1) through the lift arm support device and the bracket. Hook the spring (Item 2) [Figure 174] to the retaining pin.

Remove the jackstands.

BACK-UP ALARM SYSTEM

This machine may be equipped with a Back-up Alarm.

Description

The back-up alarm will sound when the operator moves both steering levers or joystick(s) into the reverse position. Slight movement of the controls into the reverse position is required with hydrostatic transmissions, before the back-up alarm will sound.

Inspection

See the SERVICE SCHEDULE for the correct service interval. (See SERVICE SCHEDULE on Page 122.)

The back-up alarm is located on the inside of the rear door.

Figure 175

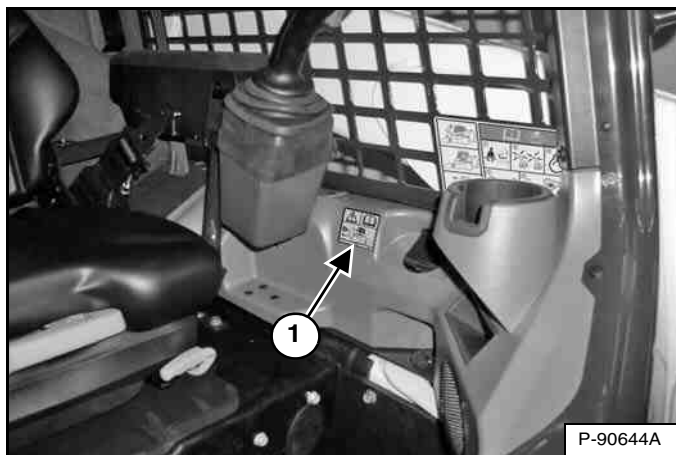

Inspect for damaged or missing back-up alarm decal (Item 1) [Figure 175]. Replace if required.

Sit in the seat and fasten the seat belt. Engage the parking brake. Pull the seat bar all the way down. Start the engine. Press the PRESS TO OPERATE LOADER button. Disengage the parking brake.

Move both steering levers or joystick(s) into the reverse position. The back-up alarm must sound when all wheels or both tracks are moving in reverse.

Figure 176

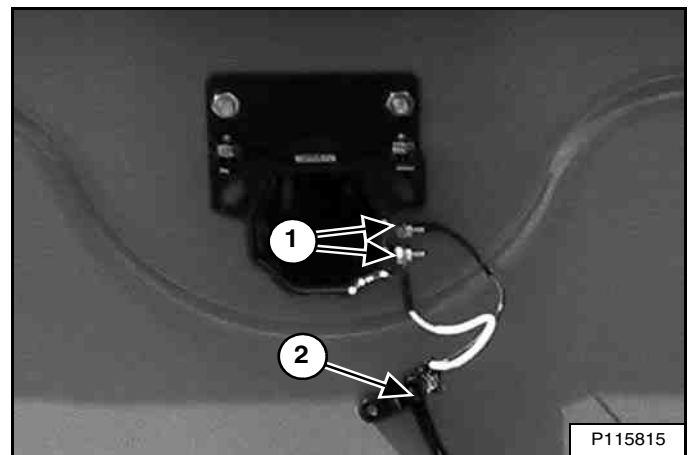

Inspect the back-up alarm electrical connections (Item 1) [Figure 176], wire harness (Item 2) [Figure 176], and back-up alarm switches (if equipped) (Item 1) [Figure 177] for tightness and damage. Repair or replace any damaged components.

If the back-up alarm switches require adjustment, (See Adjusting Switch Position on Page 133.)

BACK-UP ALARM SYSTEM (CONT'D)

Adjusting Switch Position

NOTE: Joystick equipped machines do not have back-up alarm switches and cannot be adjusted. See your Bobcat dealer for service if your back-up alarm does not sound.

Standard Controls, ACS, And AHC (If Equipped)

Stop the engine and raise the operator cab. (See Raising on Page 135.)

Put the steering levers in the NEUTRAL position.

Figure 177

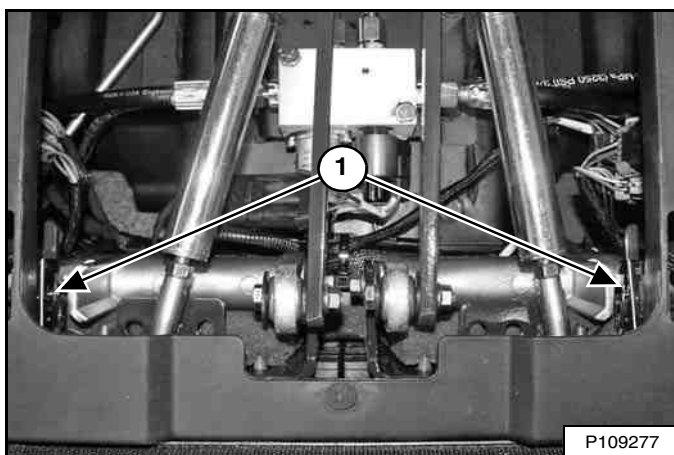

The back-up alarm switches (Item 1) [Figure 177] are located alongside the steering bellcranks. Both switches must be adjusted properly for the back-up alarm to operate correctly.

Figure 178

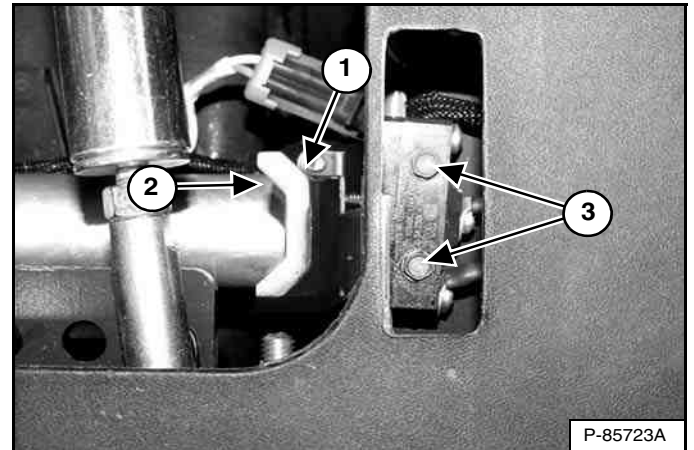

Loosen the screws (Item 3) [Figure 178] securing the back-up alarm switch. (Left side shown)

Position the back-up alarm switch so that the roller (Item 1) just makes contact with the bellcrank (Item 2) [Figure 178] without compressing the switch spring.

Torque the screws (Item 3) [Figure 178] securing the switch to the bracket to 1,0 - 1,4 N•m (9 - 12 in-lb).

Repeat adjustment procedure for the other switch.

Lower the operator cab. (See Lowering on Page 136.)

Inspect back-up alarm system for proper function. (See Inspection on Page 132.)

OPERATOR CAB

Description

The Bobcat loader has an operator cab (ROPS and FOPS) as standard equipment to protect the operator from rollover and falling objects. The seat belt must be worn for rollover protection.

Check the cab, mounting, and hardware for damage. Never modify the cab. Replace the cab and hardware if damaged. See your Bobcat dealer for parts.

ROPS - Roll-Over Protective Structure per ISO 3471 and FOPS - Falling-Object Protective Structure per ISO 3449, Level I. Level II is available.

Level I

Protection from falling bricks, small concrete blocks, and hand tools encountered in operations, such as: motorway maintenance, landscaping, and other construction sites.

Level II

Protection from falling trees, rocks: for machines involved in site clearing, overhead demolition, or forestry.

WARNING

Never modify operator cab by welding, grinding, drilling holes or adding attachments unless instructed to do so by Bobcat Company. Changes to the cab can cause loss of operator protection from rollover and falling objects, and result in injury or death.

W-2069-0200

Cab Door Sensor

This machine may be equipped with a Cab Door Sensor.

Figure 179

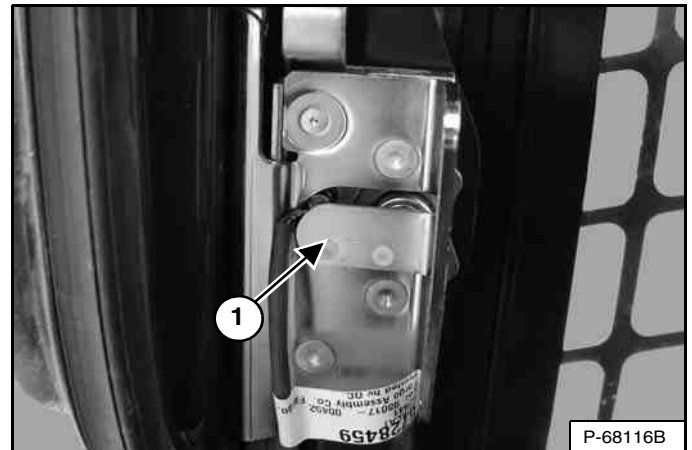

The cab door has a sensor (Item 1) [Figure 179] installed that deactivates the lift and tilt valves when the door is open.

Figure 180



The LIFT AND TILT VALVE light (Item 1) [Figure 180] is OFF when the door is closed, the key switch is turned to RUN, the seat bar is lowered, and the PRESS TO OPERATE LOADER button is pressed.

The LIFT AND TILT VALVE light (Item 1) [Figure 180] is ON when the door is open, the key switch is turned to RUN, the seat bar is lowered, and the PRESS TO OPERATE LOADER button is pressed.

[DOOR] will appear in the data display (Item 2) [Figure 180] when the door is open, the key switch is turned to RUN, the seat bar is lowered, and the PRESS TO OPERATE LOADER button is pressed.

OPERATOR CAB (CONT'D)

Raising

Always stop the engine before raising or lowering the operator cab.

Stop the loader on a level surface. Lower the lift arms. If the lift arms must be up while raising the operator cab, install the lift arm support device. (See LIFT ARM SUPPORT DEVICE on Page 129.)

Figure 181

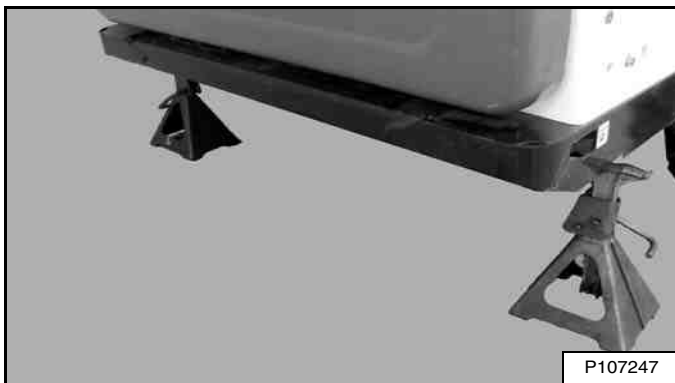

Install jackstands under the rear of the loader frame [Figure 181].

Figure 182

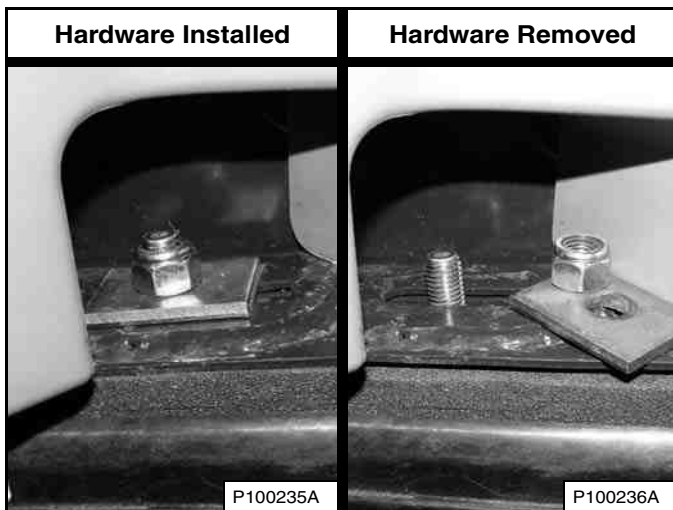

Remove the nuts and washers [Figure 182] (both sides) at the front corners of the operator cab.



UNEXPECTED LOADER, LIFT ARM OR ATTACHMENT MOVEMENT CAUSED BY CAB CONTACT WITH CONTROLS CAN CAUSE SERIOUS INJURY OR DEATH

- **STOP ENGINE** before raising or lowering cab.

W-2758-0908

NOTE: On some machines, the operator cab frame can contact the steering levers while raising or lowering the operator cab. The engine **MUST** be stopped before raising or lowering the operator cab.

Figure 183



Lift on the grab handles and bottom of the operator cab [Figure 183] slowly until the operator cab is all the way up and the latching mechanism engages.

OPERATOR CAB (CONT'D)

Lowering

Always stop the engine before raising or lowering the operator cab.

NOTE: Always use the grab handles to lower the operator cab.

Figure 184



Pull down on the bottom of the operator cab until stopped by the latching mechanism [Figure 184].

NOTE: The weight of the operator cab increases when equipped with options and accessories, such as: cab door and heater. In these cases, the operator cab may need to be raised slightly from the latch to be able to release the latch.

! WARNING

UNEXPECTED LOADER, LIFT ARM OR ATTACHMENT MOVEMENT CAUSED BY CAB CONTACT WITH CONTROLS CAN CAUSE SERIOUS INJURY OR DEATH

- **STOP ENGINE** before raising or lowering cab.

W-2758-0908

NOTE: On some machines, the operator cab frame can contact the steering levers while raising or lowering the operator cab. The engine **MUST** be stopped before raising or lowering the operator cab.

Support the operator cab and release the latching mechanism (Inset) [Figure 184]. Remove your hand from the latch mechanism when the operator cab is past the latch stop. Use both hands to lower the operator cab all the way down.

! WARNING

PINCH POINT CAN CAUSE INJURY
Remove your hand from the latching mechanism when the cab is past the latch stop.

W-2469-0803

Figure 185

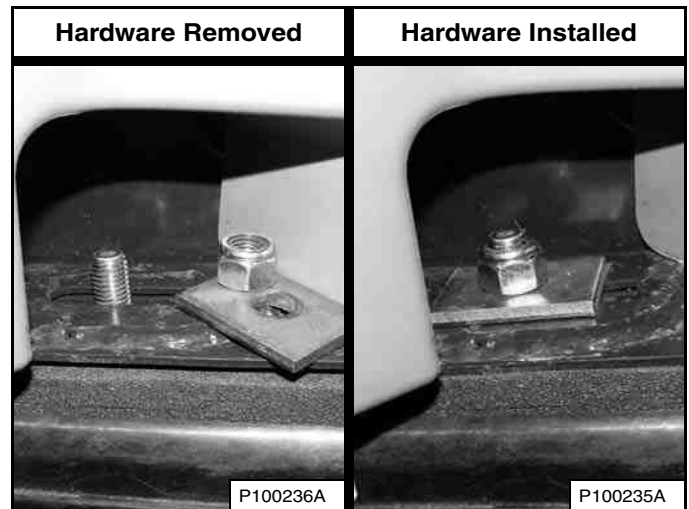

Install the washers and nuts (both sides) [Figure 185].

Tighten the nuts to 54 - 61 N•m (40 - 45 ft-lb) torque.

Remove the jackstands.

REAR DOOR (TAILGATE)

Opening And Closing

Figure 186

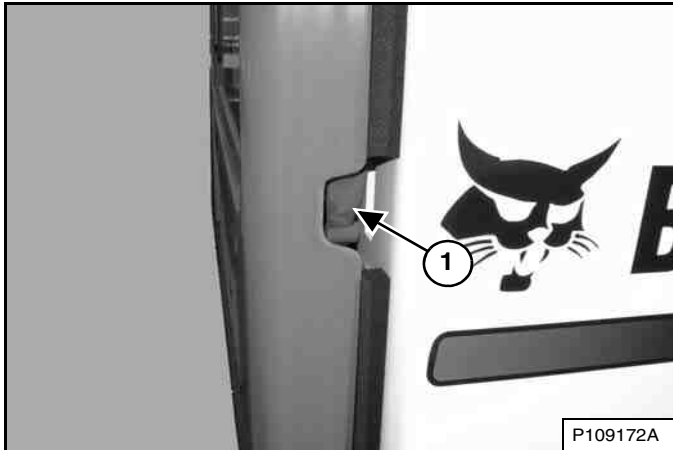

Reach into the slot on the right side of the rear door and pull the latch handle (Item 1) [Figure 186]. Pull the rear door open.

The rear door is equipped with a door stop feature on the top hinge.

Figure 187

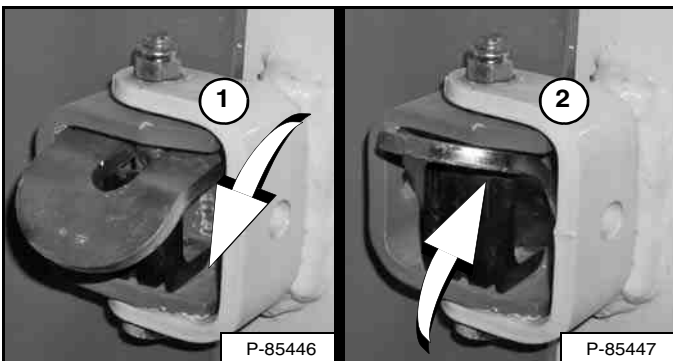

Move the door stop into the engaged position (Item 1) to hold the door open. Move the door stop up (Item 2) [Figure 187] to allow the door to close.

WARNING

Keep the rear door closed when operating the machine. Failure to do so could seriously injure a bystander.

W-2020-1285

Close the rear door.

Adjusting Latch

Figure 188

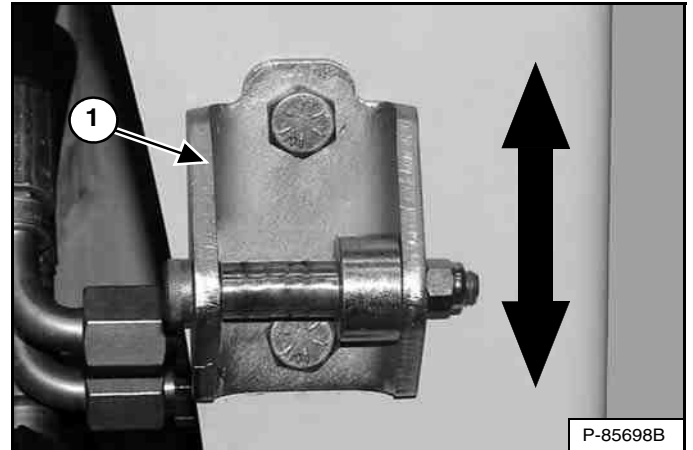

The door latch striker (Item 1) [Figure 188] can be adjusted up or down for alignment with the door latch.

Close the rear door before operating the loader.

REAR GRILLE

Removing

Stop the engine and open the rear door.

Figure 189

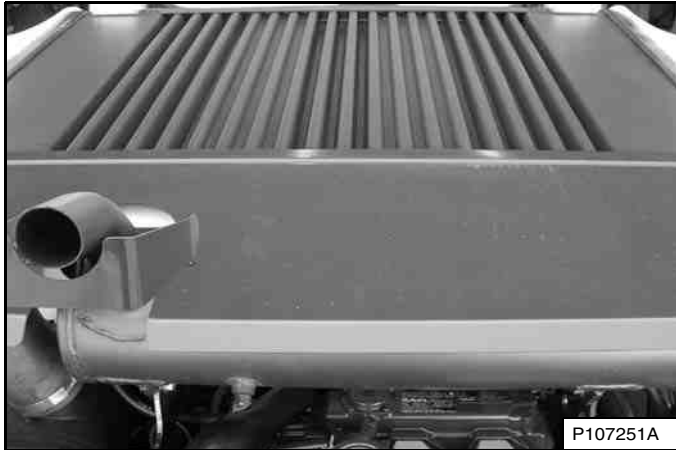

Lift and pull the rear grille backward to remove from the loader **[Figure 189]**.

Installing

Figure 190

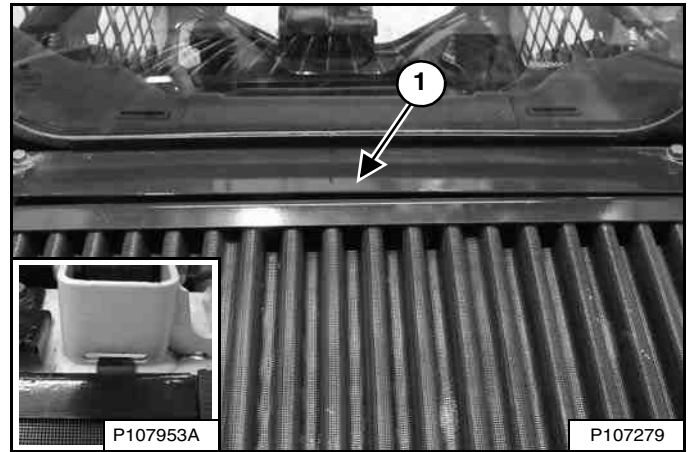

Align the edge of the rear grille under the shield (Item 1), insert the tabs into the slots (Right Side Shown) (Inset) **[Figure 190]**, and lower.

Close the rear door.

HEATING SYSTEM

This machine may be equipped with a cab heater.

Filters

See the SERVICE SCHEDULE for the correct service interval. (See SERVICE SCHEDULE on Page 122.)

Fresh Air Filters

Figure 191

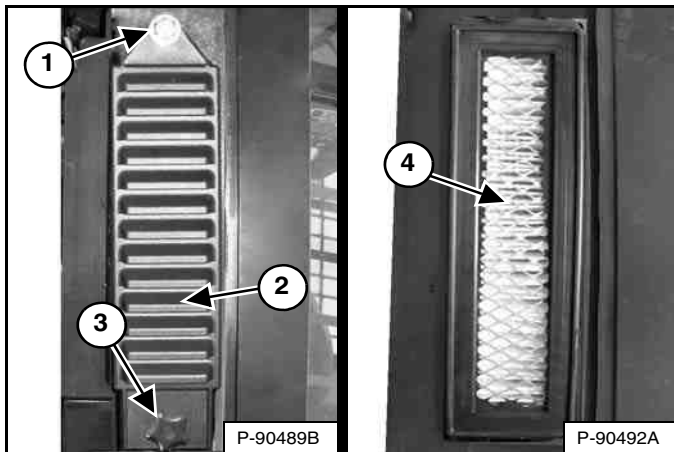

The fresh air filters are located behind the side windows outside the operator cab. (Right side shown) Remove the retaining screw (Item 3) and the filter cover (Item 2) [Figure 191]. (Lift arms shown raised for visual clarity.)

NOTE: Loosen the upper filter cover bolt (Item 1) [Figure 191] to allow removal and installation of the cover if equipped with the High-Efficiency Particulate Air (HEPA) filter kit.

Shake the filter (Item 4) [Figure 191] or use low pressure air to remove dirt. This procedure can be done several times before replacement is required. Install the filter, the filter cover, and the retaining screw.

Recirculation Filter

Figure 192

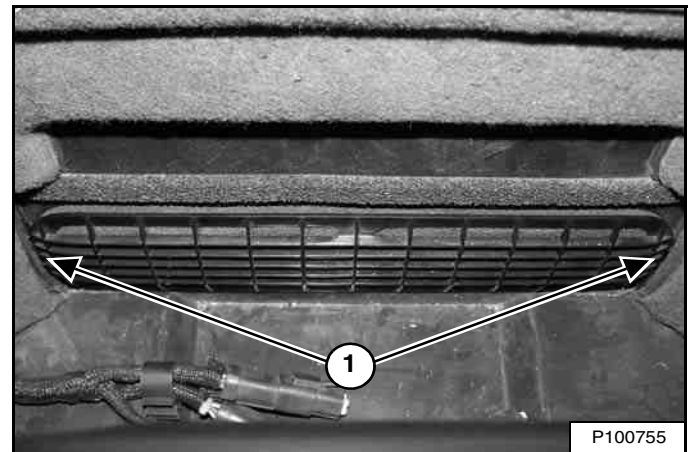

The recirculation filter is located behind the operator's seat inside the operator cab. The filter cover is held in position with three clips. Pull the cover at each end (Item 1) [Figure 192] to remove.

Rinse the filter with water or use a vacuum cleaner to clean. Do not use solvents.

Line up the clips on the filter cover with the slots provided and push the cover into position.

HEATING SYSTEM (CONT'D)

Heater Coil

Stop the engine and raise the operator cab. (See Raising on Page 135.)

Figure 193

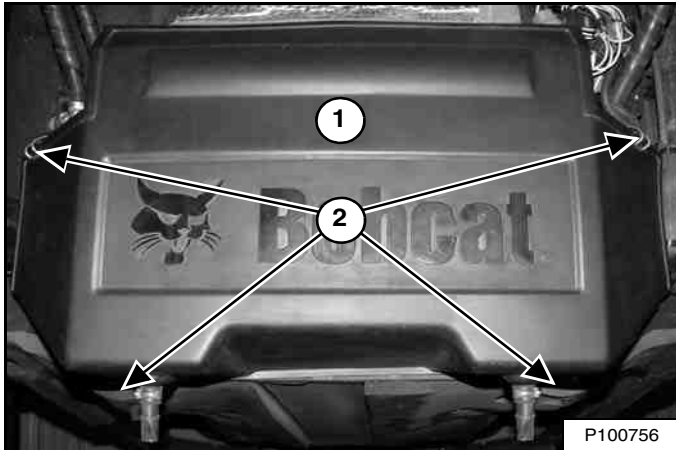

Unhook the cover latches (Item 2) and remove the cover (Item 1) [Figure 193].

Figure 194

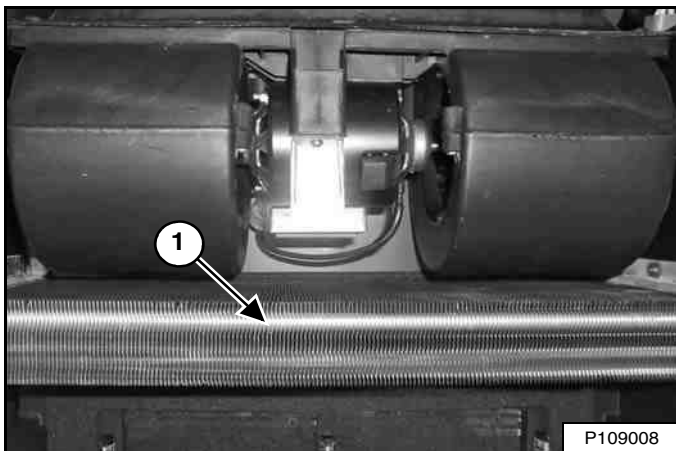

Use low pressure air or water to remove debris from the heater coil (Item 1) [Figure 194].

Install the cover [Figure 193] and lower the operator cab. (See Lowering on Page 136.)

Troubleshooting

If the fan does not operate, check the fuse. (See Fuse And Relay Location / Identification on Page 154.)

ENGINE AIR CLEANER

Replacing Filters

Figure 195



Replace the air filters only when necessary. The service indicator (Item 1) will FLASH. Press the Information button (Item 3) until the display screen shows the service codes. Service code [M0117] (Air Filter Plugged) will show in the display screen (Item 2) [Figure 195] when air filter replacement is necessary.

Replace the inner filter every third time the outer filter is replaced or as indicated.

Outer Filter

Stop the engine and open the rear door.

Figure 196

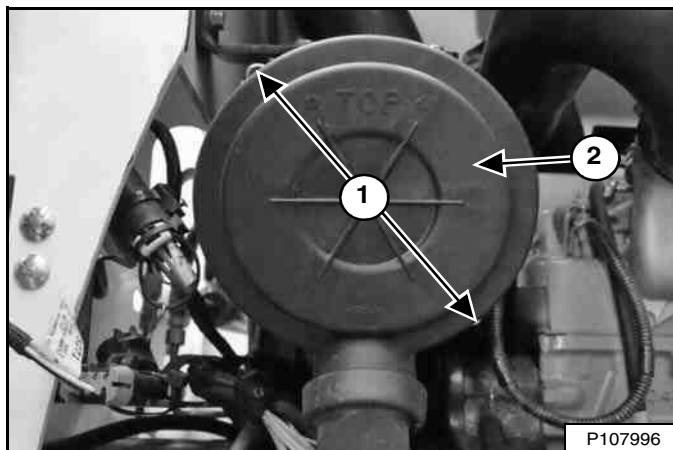

Open the latches (Item 1) and remove the cover (Item 2) [Figure 196].

Figure 197

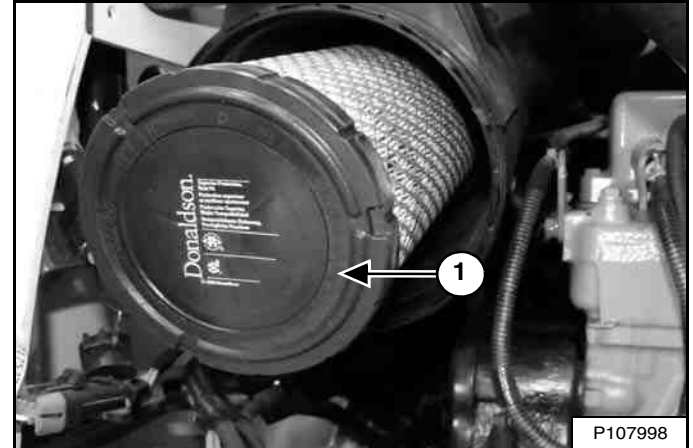

Remove the outer filter (Item 1) [Figure 197] and discard.

NOTE: Make sure the filter housing is free of dirt and debris. Verify that sealing surfaces are clean. DO NOT use compressed air.

Install new outer filter. Push in until the filter contacts the base of the housing. Install the cover and secure the latches [Figure 196].

Close the rear door.

ENGINE AIR CLEANER (CONT'D)

Replacing Filters (Cont'd)

Inner Filter

Replace the inner filter only under the following conditions:

- Replace the inner filter every *third* time the outer filter is replaced.
- After the outer filter has been replaced, start the engine and operate at full rpm. If service code **[M0117]** (Air Filter Plugged) is still displayed in the data display, replace the inner filter.

Stop the engine and open the rear door.

Remove the cover **[Figure 196]** and the outer filter **[Figure 197]**.

Figure 198

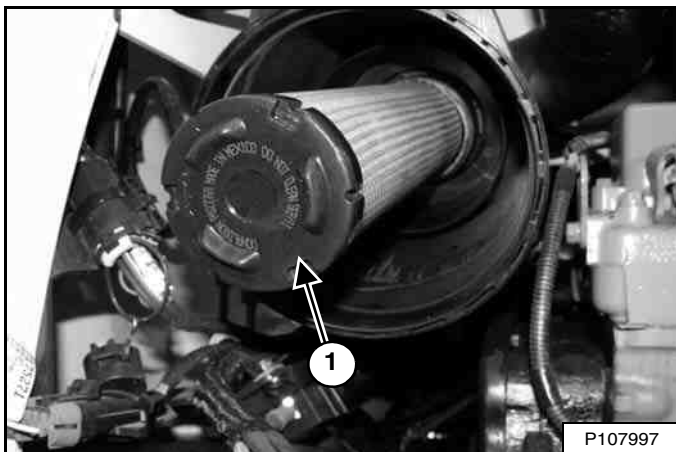

Remove the inner filter (Item 1) **[Figure 198]**.

NOTE: Make sure the filter housing is free of dirt and debris. Verify that sealing surfaces are clean. **DO NOT** use compressed air.

Install new inner filter. Push in until the filter contacts the base of the housing.

Install the outer filter **[Figure 197]**.

Figure 199

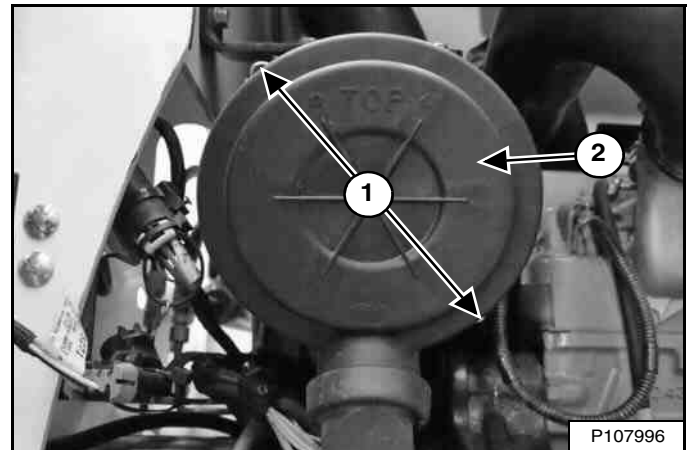

Install the cover (Item 2) and secure the latches (Item 1) **[Figure 199]**.

Close the rear door.



FUEL SYSTEM

Fuel Specifications

NOTE: Contact your local fuel supplier to receive recommendations for your region.

At a minimum, low sulfur diesel fuel must be used in this machine. Low sulfur is defined as 500 mg/kg (500 ppm) sulfur maximum.

U.S. Standard (ASTM D975)

Use only clean, high quality diesel fuel, Grade Number 2-D or Grade Number 1-D.

Ultra low sulfur diesel fuel may also be used in this machine. Ultra low sulfur is defined as 15 mg/kg (15 ppm) sulfur maximum.

The following is one suggested blending guideline that should prevent fuel gelling during cold temperatures:

TEMPERATURE	GRADE 2-D	GRADE 1-D
Above -9°C (+15°F)	100%	0%
Down to -21°C (-5°F)	50%	50%
Below -21°C (-5°F)	0%	100%

NOTE: Biodiesel blend fuel may also be used in this machine. Biodiesel blend fuel must contain no more than five percent biodiesel mixed with ultra low sulfur petroleum based diesel. This biodiesel blend fuel is commonly marketed as B5 blended diesel fuel. B5 blended diesel fuel must meet ASTM specifications.

E.U. Standard (EN590)

Use only clean, high quality diesel fuel that meets the specifications listed below:

- Low sulfur diesel fuel defined as 500 mg/kg (500 ppm) sulfur maximum
- Diesel fuel with cetane number of 51.0 and above.

Clean, high quality diesel fuel that meets the EN590 specification may also be used.

NOTE: Biodiesel blend fuel may also be used in this machine. Biodiesel blend fuel must contain no more than seven percent biodiesel mixed with ultra low sulfur petroleum based diesel. This biodiesel blend fuel is commonly marketed as B7 blended diesel fuel. B7 blended diesel fuel must meet EN590 specifications.

Biodiesel Blend Fuel

Biodiesel blend fuel has unique qualities that should be considered before using in this machine:

- Cold weather conditions can lead to plugged fuel system components and hard starting.
- Biodiesel blend fuel is an excellent medium for microbial growth and contamination that can cause corrosion and plugging of fuel system components.
- Use of biodiesel blend fuel may result in premature failure of fuel system components, such as: plugged fuel filters and deteriorated fuel lines.
- Shorter maintenance intervals may be required, such as: cleaning the fuel system and replacing fuel filters and fuel lines.
- Using biodiesel blended fuels containing more than five percent biodiesel can affect engine life and cause deterioration of hoses, tubelines, injectors, injector pump, and seals.

Apply the following guidelines if biodiesel blend fuel is used:

- Ensure the fuel tank is as full as possible at all times to prevent moisture from collecting in the fuel tank.
- Ensure that the fuel tank cap is securely tightened.
- Biodiesel blend fuel can damage painted surfaces, remove all spilled fuel from painted surfaces immediately.
- Drain all water from the fuel filter daily before operating the machine.
- Do not exceed engine oil change interval. Extended oil change intervals can cause engine damage.
- Before machine storage; drain the fuel tank, refill with 100% petroleum diesel fuel, add fuel stabiliser, and operate the engine for at least 30 minutes.

NOTE: Biodiesel blend fuel does not have long term stability and should not be stored for more than 3 months.

FUEL SYSTEM (CONT'D)

Filling The Fuel Tank

! WARNING

AVOID INJURY OR DEATH

Stop and cool the engine before adding fuel. **NO SMOKING!** Failure to obey warnings can cause an explosion or fire.

W-2063-0807

Stop the engine and open the rear door.

Figure 200

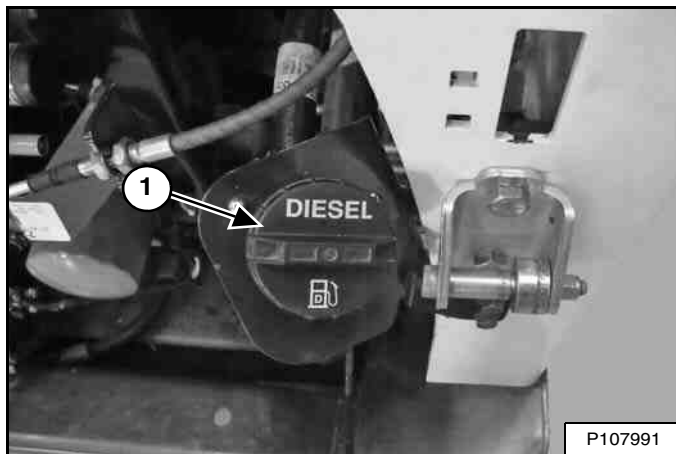

Remove the fill cap (Item 1) [Figure 200].

Figure 201

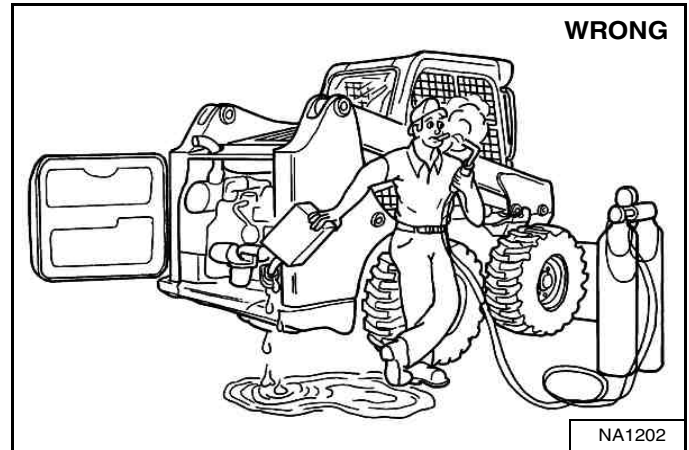

Use a clean, approved safety container to add fuel of the correct specification. Add fuel only in an area that has free movement of air and no open flames or sparks. **NO SMOKING** [Figure 201].

Install and tighten the fuel cap (Item 1) [Figure 200].

Close the rear door.

! WARNING

AVOID INJURY OR DEATH

Always clean up spilled fuel or oil. Keep heat, flames, sparks or lighted tobacco away from fuel and oil. Failure to use care around combustibles can cause explosion or fire.

W-2103-0508

FUEL SYSTEM (CONT'D)

Fuel Filter

Removing Water

See the SERVICE SCHEDULE for the correct service interval. (See SERVICE SCHEDULE on Page 122.)

Stop the engine and open the rear door.

Figure 202

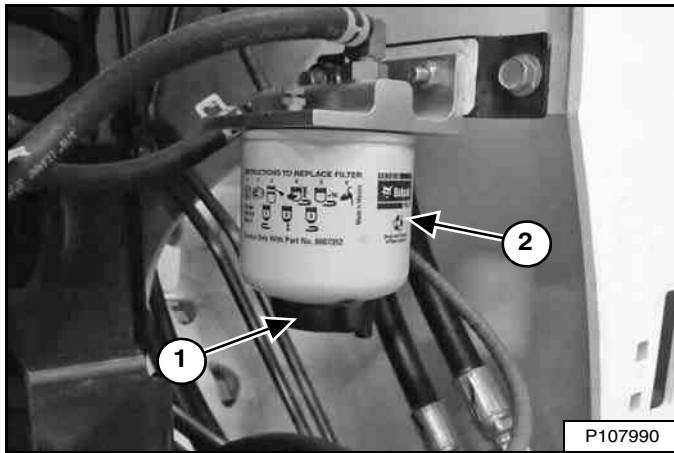

Loosen the drain (Item 1) [Figure 202] at the bottom of the filter to remove trapped water from the filter.

Securely tighten the drain.

! WARNING

AVOID INJURY OR DEATH

Always clean up spilled fuel or oil. Keep heat, flames, sparks or lighted tobacco away from fuel and oil. Failure to use care around combustibles can cause explosion or fire.

W-2103-0508

Close the rear door.

Replacing Filter

See the SERVICE SCHEDULE for the correct service interval. (See SERVICE SCHEDULE on Page 122.)

Stop the engine and open the rear door.

Remove the fuel filter (Item 2) [Figure 202].

Clean the area around the filter base. Put clean oil on the seal of the new filter. Install the filter and hand tighten.

Remove air from the fuel system. (See Removing Air From The Fuel System on Page 146.)

! WARNING

AVOID INJURY OR DEATH

Always clean up spilled fuel or oil. Keep heat, flames, sparks or lighted tobacco away from fuel and oil. Failure to use care around combustibles can cause explosion or fire.

W-2103-0508

Close the rear door.

Start the engine and allow to operate for one minute.

! WARNING

AVOID INJURY OR DEATH

Diesel fuel or hydraulic fluid under pressure can penetrate skin or eyes, causing serious injury or death. Fluid leaks under pressure may not be visible. Use a piece of cardboard or wood to find leaks. Do not use your bare hand. Wear safety goggles. If fluid enters skin or eyes, get immediate medical attention from a doctor familiar with this injury.

W-2072-EN-0909

Stop the engine and check for leaks at the filter.

FUEL SYSTEM (CONT'D)

Removing Air From The Fuel System

After replacing the filter or if the fuel tank has run out of fuel, the air must be removed from the fuel system before starting the engine.

! WARNING

AVOID INJURY OR DEATH

Diesel fuel or hydraulic fluid under pressure can penetrate skin or eyes, causing serious injury or death. Fluid leaks under pressure may not be visible. Use a piece of cardboard or wood to find leaks. Do not use your bare hand. Wear safety goggles. If fluid enters skin or eyes, get immediate medical attention from a doctor familiar with this injury.

W-2072-EN-0909

Figure 203



Open the air vent plug (Item 1) [Figure 203] on the fuel filter base.

Figure 204

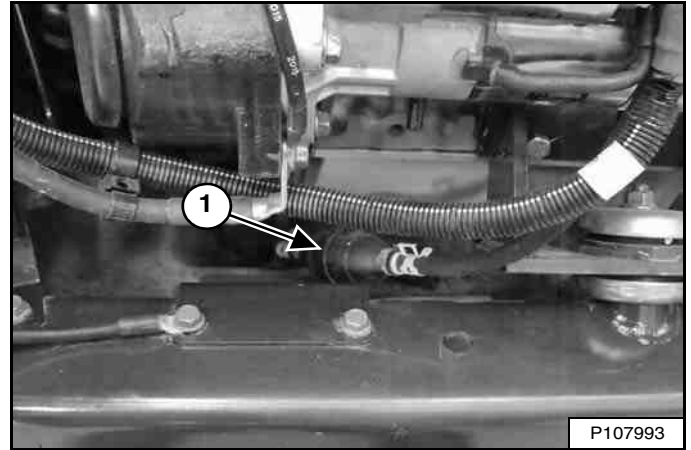

Squeeze the hand pump (priming bulb) (Item 1) [Figure 204] until fuel flows from the vent with no air bubbles.

Close the vent (Item 1) [Figure 203].

! WARNING

AVOID INJURY OR DEATH

Always clean up spilled fuel or oil. Keep heat, flames, sparks or lighted tobacco away from fuel and oil. Failure to use care around combustibles can cause explosion or fire.

W-2103-0508

ENGINE LUBRICATION SYSTEM

Checking And Adding Engine Oil

Check the engine oil level every day before starting the engine for the work shift.

Figure 205

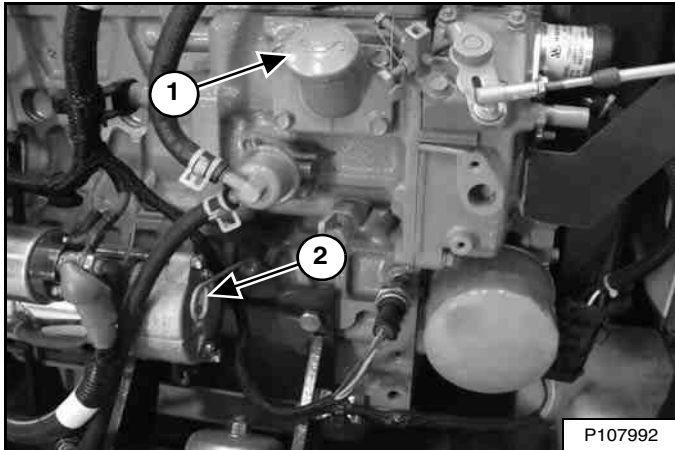

Park the loader on a level surface. Stop the engine. Open the rear door and remove the dipstick (Item 2) [Figure 205].

Keep the oil level between the marks on the dipstick. Do not overfill.

Remove the oil fill cap (Item 1) [Figure 205] to add engine oil.

WARNING

AVOID INJURY OR DEATH

Always clean up spilled fuel or oil. Keep heat, flames, sparks or lighted tobacco away from fuel and oil. Failure to use care around combustibles can cause explosion or fire.

W-2103-0508

Close the rear door.

Engine Oil Chart

Figure 206

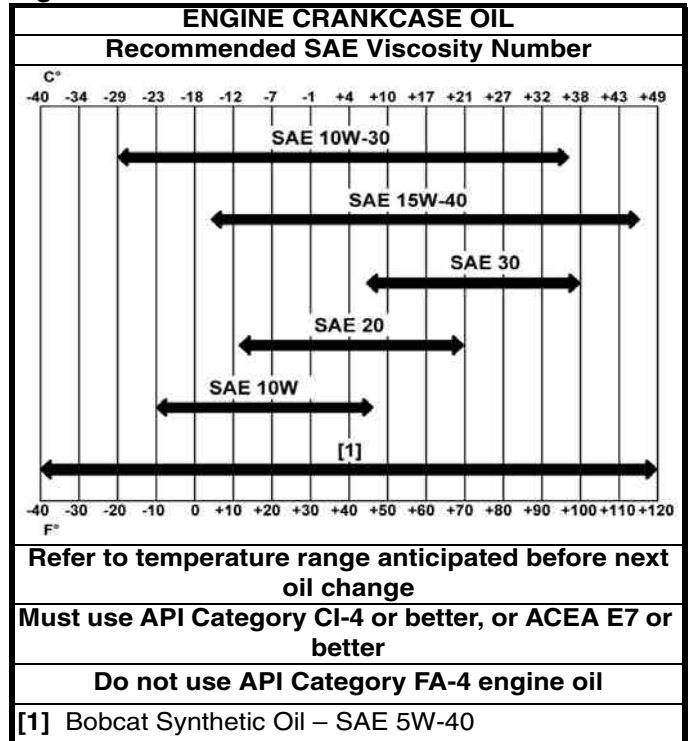

Bobcat engine oils are recommended for use in this machine. If Bobcat engine oil is not available, use a good quality engine oil that meets API Service Category of CI-4 or better, or ACEA E7 or better [Figure 206].

IMPORTANT

AVOID ENGINE DAMAGE

Use of API Service Category FA-4 engine oil is not approved and may cause irreversible damage to the engine.

I-2384-0916

ENGINE LUBRICATION SYSTEM (CONT'D)

Removing And Replacing Oil And Filter

See the SERVICE SCHEDULE for the correct service interval. (See SERVICE SCHEDULE on Page 122.)

Operate the engine until coolant reaches normal operating temperature. Stop the engine.

Figure 207

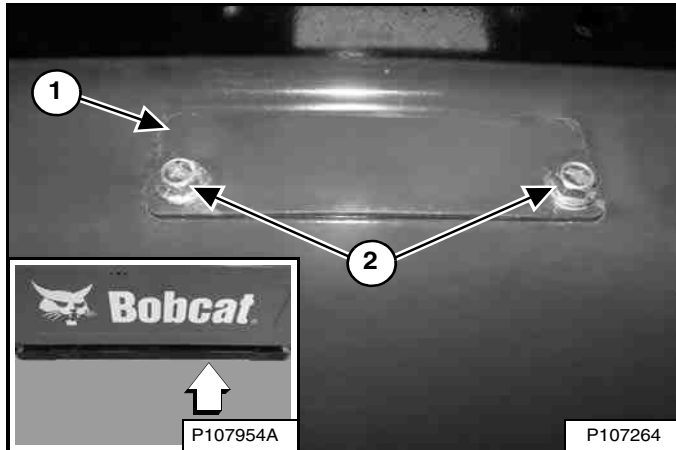

The oil drain hose is located behind a cover (Item 1) under the rear of the loader (Inset) [Figure 207].

Loosen one cover mounting bolt and remove the other bolt (Item 2) [Figure 207] to allow the cover to swing open.

Figure 208

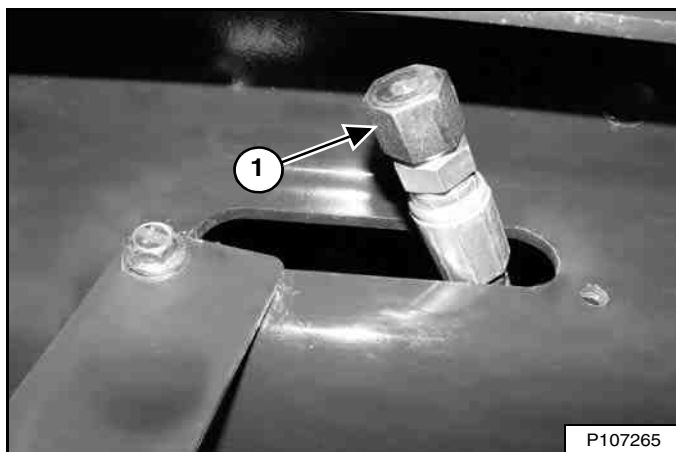

Remove the oil drain cap (Item 1) [Figure 208] from the oil drain hose and drain the oil into a container. Recycle or dispose of used oil in an environmentally safe manner.

Install and tighten the oil drain cap [Figure 208].

Install the cover and the cover mounting bolts [Figure 207]. Tighten both bolts.

Figure 209

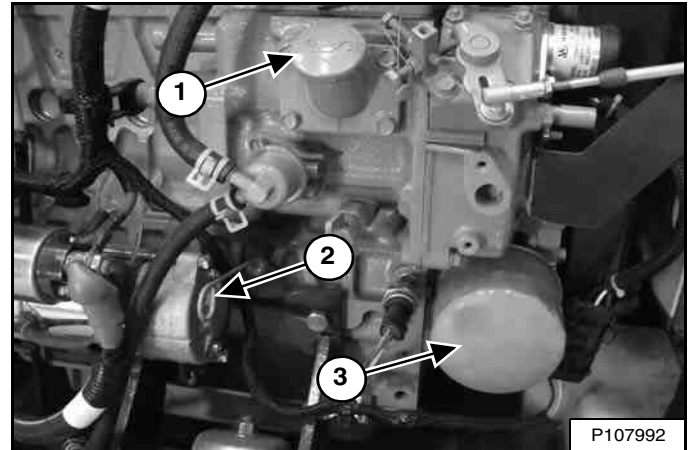

Open the rear door, remove the oil filter (Item 3) [Figure 209], and clean the filter base.

Put clean oil on the new filter gasket, install the new filter, and hand tighten. Use genuine Bobcat filter only.

Remove the oil fill cap (Item 1) [Figure 209].

Put oil in the engine and replace the fill cap. (See Capacities on Page 204.) Do not overfill.

Start the engine and allow to operate for several minutes. Stop the engine and check for leaks at the filter.

Remove the dipstick (Item 2) [Figure 209] and check the oil level.

Add oil as needed if oil level is not at the top mark on the dipstick. Install the dipstick and close the rear door.

WARNING

AVOID INJURY OR DEATH

Always clean up spilled fuel or oil. Keep heat, flames, sparks or lighted tobacco away from fuel and oil. Failure to use care around combustibles can cause explosion or fire.

W-2103-0508

ENGINE COOLING SYSTEM

Check the cooling system every day to prevent overheating, loss of performance, or engine damage.

Maintenance Platform

Figure 210

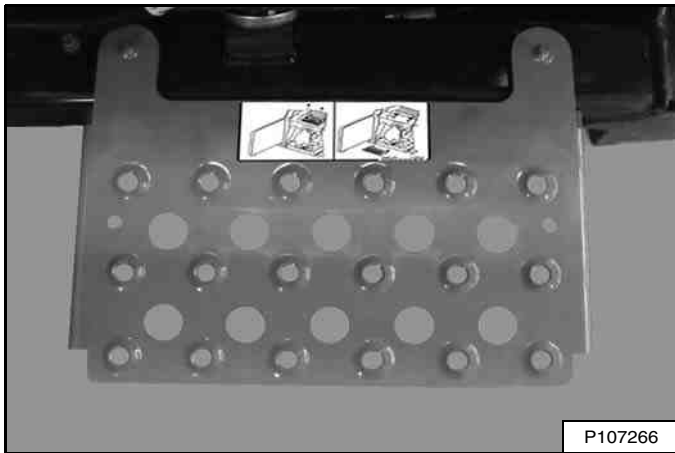

A maintenance platform [Figure 210] is available from your Bobcat dealer to facilitate access when cleaning the engine cooling system.

Cooling System Identification

NOTE: Identification of the cooling system used on your machine is necessary to perform the correct cleaning procedure.

Figure 211

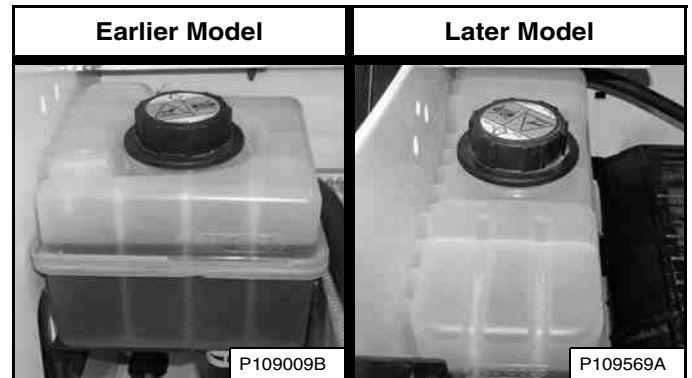

Earlier models have a square coolant tank. Later models have a rectangular coolant tank [Figure 211].

ENGINE COOLING SYSTEM (CONT'D)

Cleaning (Earlier Models)

See the SERVICE SCHEDULE for the correct service interval. (See SERVICE SCHEDULE on Page 122.)

Stop the engine, open the rear door, and remove the rear grille. (See REAR GRILLE on Page 138.)

! WARNING

AVOID INJURY OR DEATH

Wear safety glasses to prevent eye injury when any of the following conditions exist:

- When fluids are under pressure.
- Flying debris or loose material is present.
- Engine is running.
- Tools are being used.

W-2019-0907

Figure 212

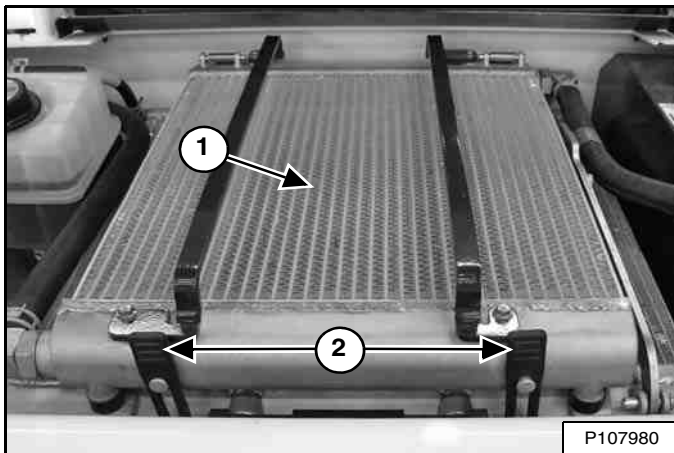

Use low air pressure or water pressure to clean the top of the hydraulic fluid cooler (Item 1) [Figure 212].

Unhook the two rubber straps (Item 2) [Figure 212].

Figure 213

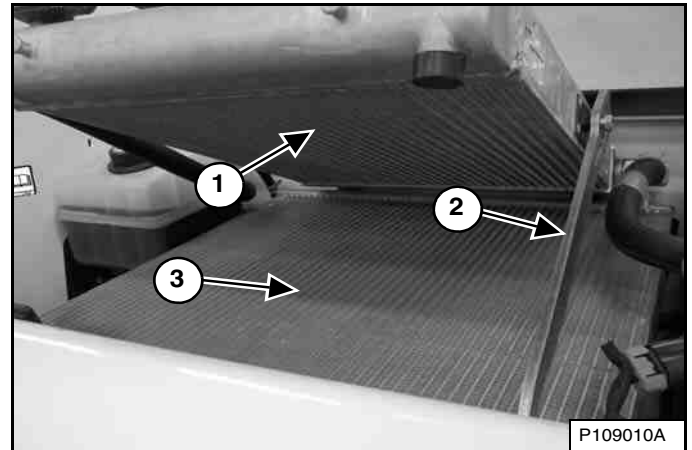

Raise the hydraulic fluid cooler (Item 1) until the support bar (Item 2) drops into position to support the hydraulic fluid cooler. Use low air pressure or water pressure to clean the top of the radiator (Item 3) [Figure 213].

Raise the support bar (Item 2) [Figure 213] slightly and lower the hydraulic fluid cooler.

Fasten the two rubber straps [Figure 212].

Check the cooling system for leaks.

Install the rear grille and close the rear door.

ENGINE COOLING SYSTEM (CONT'D)

Cleaning (Later Models)

See the SERVICE SCHEDULE for the correct service interval. (See SERVICE SCHEDULE on Page 122.)

Stop the engine, open the rear door, and remove the rear grille. (See REAR GRILLE on Page 138.)

! WARNING

AVOID INJURY OR DEATH

Wear safety glasses to prevent eye injury when any of the following conditions exist:

- When fluids are under pressure.
- Flying debris or loose material is present.
- Engine is running.
- Tools are being used.

W-2019-0907

Figure 214

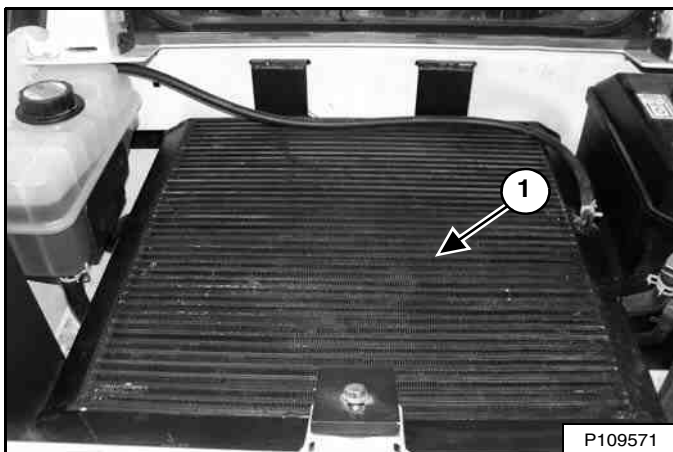

Use low air pressure or water pressure to clean the top of the hydraulic fluid cooler and radiator assembly (Item 1) [Figure 214].

Check the cooling system for leaks.

Install the rear grille and close the rear door.

ENGINE COOLING SYSTEM (CONT'D)

Checking And Adding Coolant

Check the engine coolant level every day before starting the engine for the work shift.

Stop the engine, open the rear door, and remove the rear grille. (See REAR GRILLE on Page 138.)

Figure 215

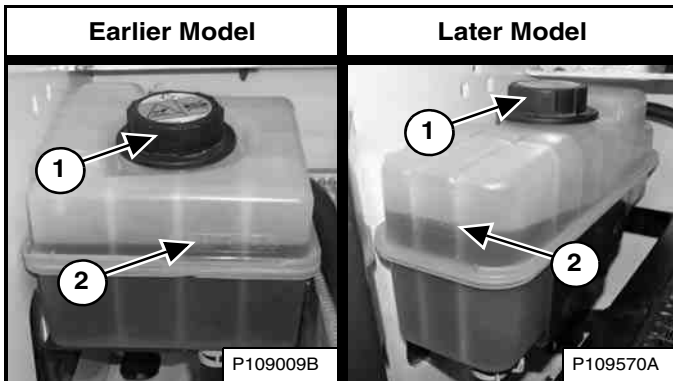

Coolant must be between the top and bottom level markers (Item 2) [Figure 215] when the engine is cold.

NOTE: The loader is factory filled with propylene glycol coolant (purple colour). DO NOT mix propylene glycol with ethylene glycol.

Use a refractometer to check the condition of propylene glycol in your cooling system.



AVOID INJURY

Stop the engine and allow to cool before adding coolant or you can be burned.

W-2106-0907

Remove the coolant fill cap (Item 1) [Figure 215] to add coolant.

The correct mixture of coolant to provide a -37°C (-34°F) freeze protection is 5 L propylene glycol mixed with 4,4 L of water **OR** 1 U.S. gal propylene glycol mixed with 3.5 qt of water.

IMPORTANT

AVOID ENGINE DAMAGE

Always use the correct ratio of water to antifreeze.

Too much antifreeze reduces cooling system efficiency and may cause serious premature engine damage.

Too little antifreeze reduces the additives which protect the internal engine components; reduces the boiling point and freeze protection of the system.

Always add a premixed solution. Adding full strength concentrated coolant can cause serious premature engine damage.

I-2124-0497

Add premixed coolant, 47% water and 53% propylene glycol to the coolant tank until the coolant level reaches the upper level marker on the tank [Figure 215].

Install the coolant fill cap [Figure 215].

NOTE: The coolant fill cap must be tightened until the cap clicks.

Install the rear grille and close the rear door.

ENGINE COOLING SYSTEM (CONT'D)

Removing And Replacing Coolant

See the SERVICE SCHEDULE for the correct service interval. (See SERVICE SCHEDULE on Page 122.)

Stop the engine, open the rear door, and remove the rear grille. (See REAR GRILLE on Page 138.)



AVOID INJURY

Do not remove engine coolant cap when the engine is hot. You can be seriously burned.

W-2607-0804

Figure 216

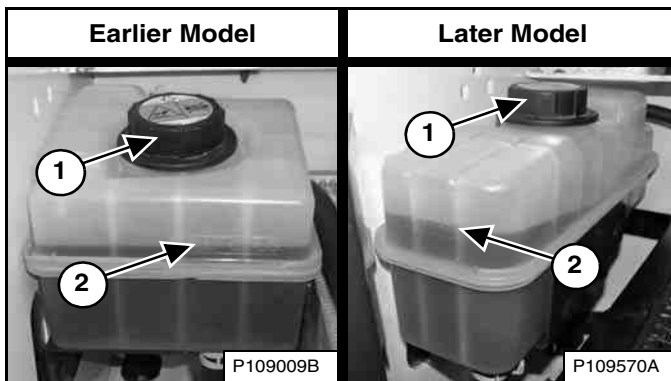

Remove the coolant fill cap (Item 1) [Figure 216].

Figure 217

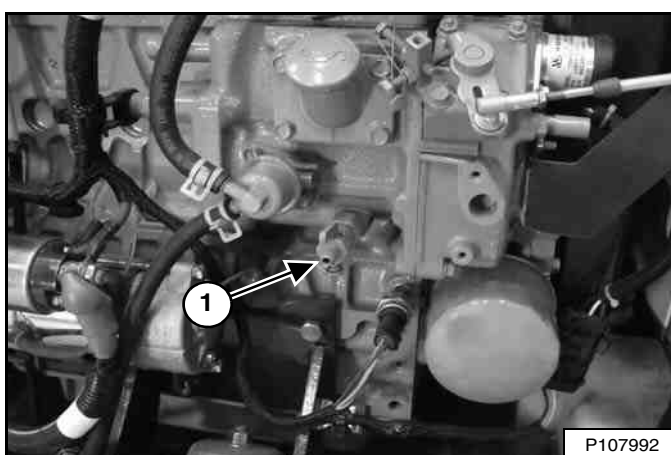

Attach a hose to the coolant drain petcock (Item 1) [Figure 217] located to the left of the oil filter. Open the petcock and drain the coolant into a container. Close the petcock and remove the hose.

Recycle or dispose of used coolant in an environmentally safe manner.

Mix new coolant in a separate container. (See Capacities on Page 204.)

The correct mixture of coolant to provide a -37°C (-34°F) freeze protection is 5 L propylene glycol mixed with 4,4 L of water **OR** 1 U.S. gal propylene glycol mixed with 3.5 qt of water.



AVOID ENGINE DAMAGE

Always use the correct ratio of water to antifreeze.

Too much antifreeze reduces cooling system efficiency and may cause serious premature engine damage.

Too little antifreeze reduces the additives which protect the internal engine components; reduces the boiling point and freeze protection of the system.

Always add a premixed solution. Adding full strength concentrated coolant can cause serious premature engine damage.

I-2124-0497

Add premixed coolant, 47% water and 53% propylene glycol to the coolant tank until the coolant level reaches the lower level marker on the tank (Item 2) [Figure 216].

Install the coolant fill cap [Figure 216].

NOTE: The coolant fill cap must be tightened until the cap clicks.

Install the rear grille and close the rear door.

Operate the engine until coolant reaches normal operating temperature. Stop the engine.

Check the coolant level when cool. Add coolant as needed. (See Checking And Adding Coolant on Page 152.)

ELECTRICAL SYSTEM

Description

Figure 218

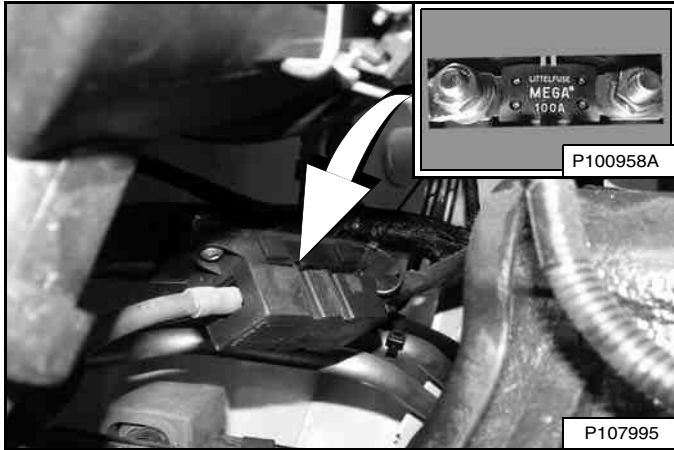

The loader has a 12 volt, negative earth, alternator charging system.

The electrical system is protected by fuses located in the operator cab and a 100 ampere master fuse (Inset) [Figure 218] located above the battery in the engine compartment.

The fuses will protect the electrical system when there is an electrical overload. The reason for the overload must be found before starting the engine again.

Fuse And Relay Location / Identification

Figure 219

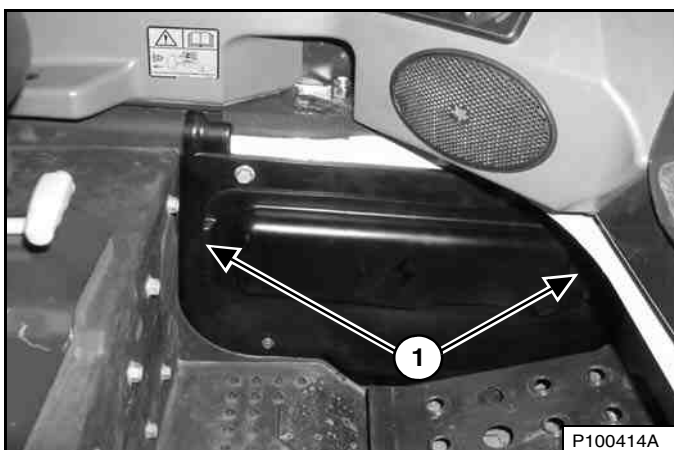

The fuse / relay panel is located behind an access panel near the left foot pedal / footrest. Pull the panel at each end (Item 1) [Figure 219] to remove.

Figure 220

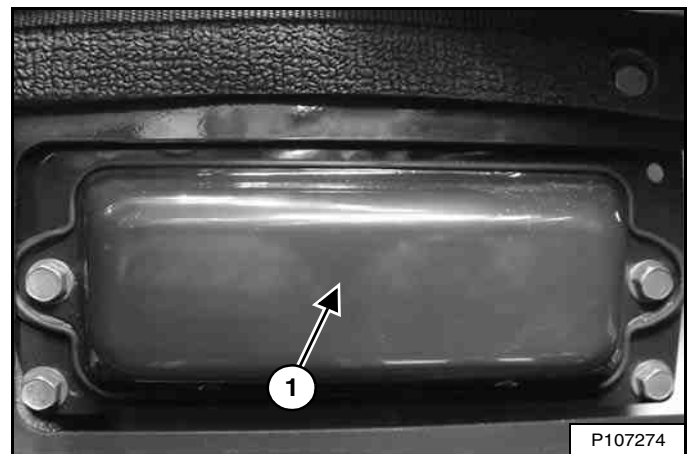

The electrical system is protected from overload by fuses located under the fuse panel cover (Item 1) [Figure 220].

Figure 221

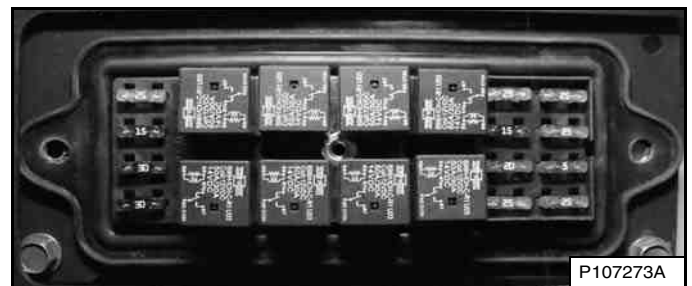

Remove the fuse panel cover to check or replace the fuses and relays [Figure 221].

A decal located inside the access panel indicates fuse / relay location and fuse amperage ratings.

Install the fuse panel cover [Figure 220].

Line up the clips on the access panel with the slots provided and push the panel into position [Figure 219]. A locating pin helps align the panel during installation.

A table is provided with details on amperage ratings and the circuits affected by each fuse and relay. (See Figure 222 on Page 155.) or (See Figure 223 on Page 156.)



ELECTRICAL SYSTEM (CONT'D)

Fuse And Relay Location / Identification (Cont'd)

Figure 222

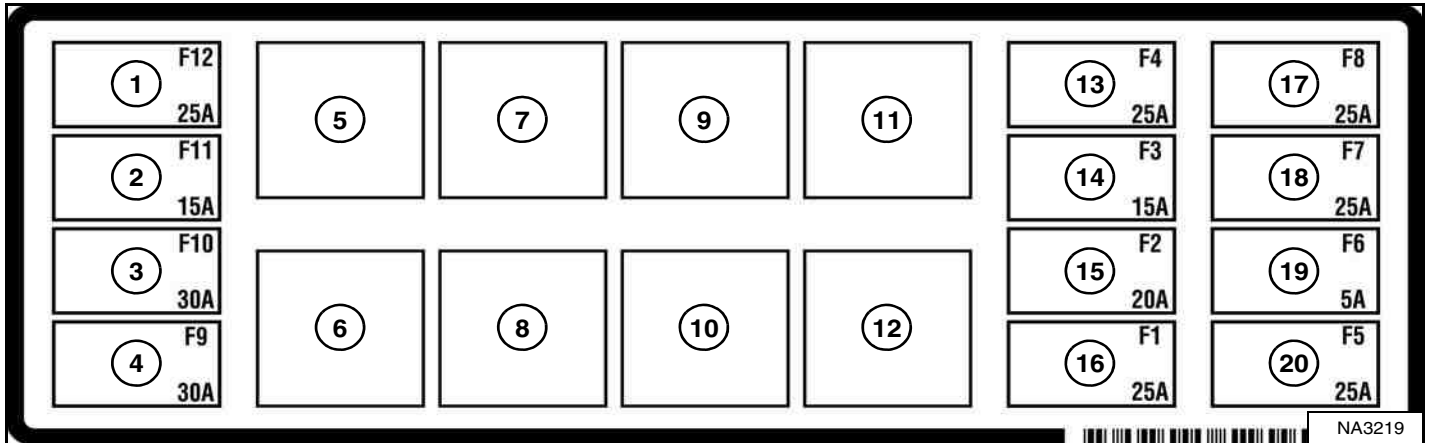

The table below is for models with decal part number 7223425. Fuse location and amperage ratings are shown in the table below and on the decal [Figure 222]. Relays are identified by the letter “R” in the AMP column.

REF	ICON	DESCRIPTION	AMP	REF	ICON	DESCRIPTION	AMP	REF	ICON	DESCRIPTION	AMP
1		ACS / Drive Controllers	25	8		Rear Lights	R	15		Front Lights	20
2		Power Port	15	9		Fuel Shutoff	R	16		Heater / HVAC	25
3		Fuel Shutoff	30	10		Front Lights	R	17		Switched Power and ACD	25
4		Traction	30	11		Switched Power	R	18		Switched Power and Back-up Alarm	25
5		Starter	R	12		Heater / HVAC	R	19		Switched Power	5
6		Glow Plugs	R	13		Gateway / Auxiliary Controllers	25	20		Accessories and Front Horn	25
7		Traction	R	14		Rear Lights	15				



ELECTRICAL SYSTEM (CONT'D)

Fuse And Relay Location / Identification (Cont'd)

Figure 223

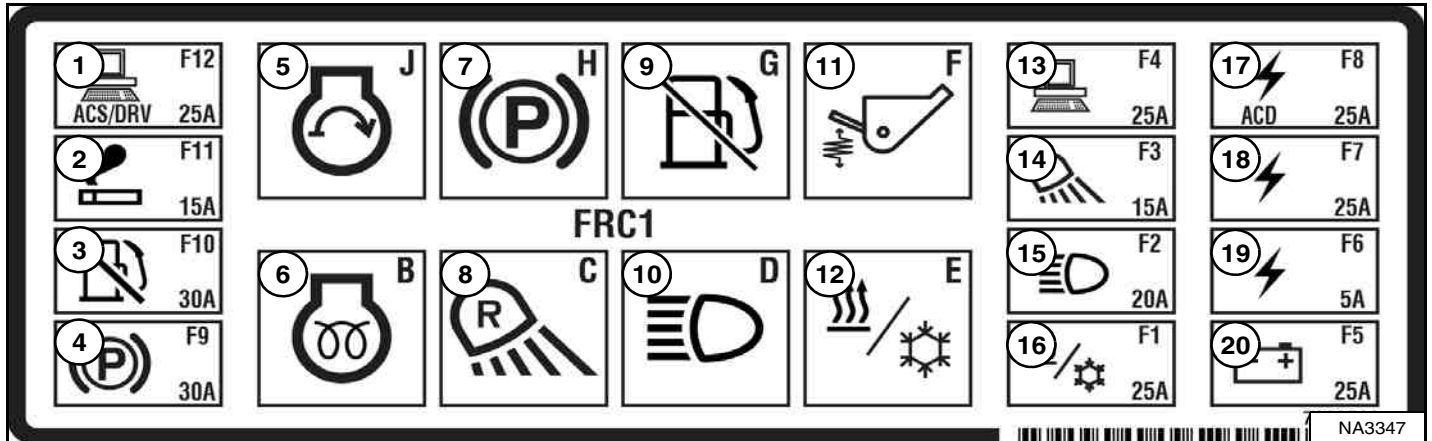

The table below is for models with decal part number 7323562. The location and amperage ratings are shown in the table below and on the decal [Figure 223]. Relays are identified by the letter “R” in the AMP column.

REF	ICON	DESCRIPTION	AMP	REF	ICON	DESCRIPTION	AMP	REF	ICON	DESCRIPTION	AMP
1		ACS / Drive Controllers	25	8		Rear Lights	R	15		Front Lights	20
2		Power Port	15	9		Fuel Shutoff	R	16		Heater / HVAC	25
3		Fuel Shutoff	30	10		Front Lights	R	17		Switched Power and ACD	25
4		Traction	30	11		Automatic Ride Control	R	18		Switched Power and Back-up Alarm	25
5		Starter	R	12		Heater / HVAC	R	19		Switched Power	5
6		Glow Plugs	R	13		Gateway / Auxiliary Controllers	25	20		Accessories and Front Horn	25
7		Traction	R	14		Rear Lights	15				

ELECTRICAL SYSTEM (CONT'D)

Fuse And Relay Location / Identification (Cont'd)

Figure 224

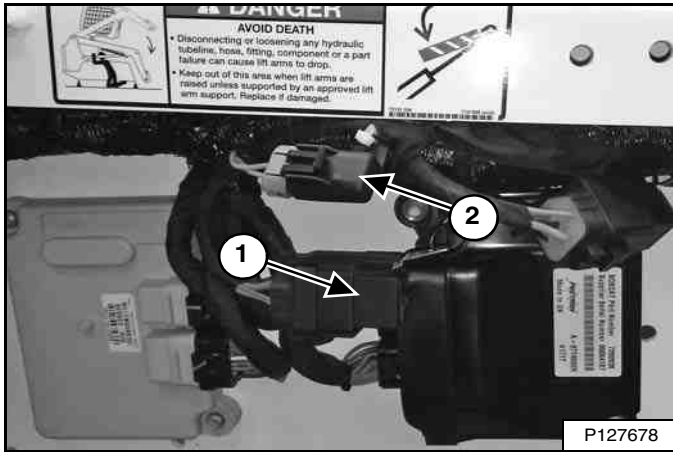

A relay (Item 1) [Figure 224] for the heated seat is located under the operator cab on the left side of the loader. The relay is normally located above the harness. Stop the engine and raise the operator cab to access the relay. (See Raising on Page 135.)

A 25 ampere fuse (Item 2) [Figure 224] for the heated seat is located under the operator cab on the left side of the loader. The fuse is normally located above the harness. Stop the engine and raise the operator cab to access the fuse. (See Raising on Page 135.)

ELECTRICAL SYSTEM (CONT'D)

Battery Maintenance

See the SERVICE SCHEDULE for the correct service interval. (See SERVICE SCHEDULE on Page 122.)

The Bobcat brand battery supplied with your machine is sealed and does not require watering. Proper charging and storage are important to maximize the life of all batteries.

Figure 225

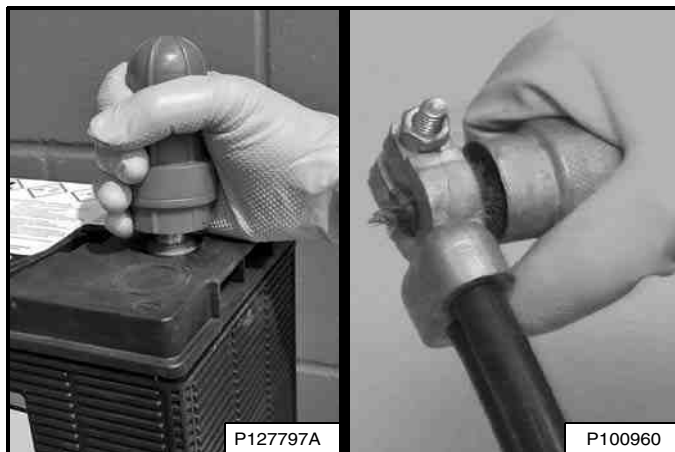

Simple steps for reliability and long battery life:

- Keep battery posts and terminals clean [Figure 225].
- Keep terminals tight.
- Remove corrosion from battery and terminals with sodium bicarbonate (baking soda) and water solution.
- Put Bobcat Battery Saver or grease on the battery terminals and cable ends to prevent corrosion.
- Operate the machine for at least 15 minutes to recover from the battery drain caused by engine start up whenever practical.
- Maintain the battery charge level. This is a key factor for long battery life.
- Charge a severely discharged battery with a battery charger instead of relying on the machine charging system. (See Battery Charging on Page 159.)
- Check the battery state of charge every 30 days on machines that are not frequently used. (See Battery Testing on Page 159.)

WARNING

AVOID INJURY OR DEATH

Batteries contain acid which burns eyes and skin on contact. Wear goggles, protective clothing and rubber gloves to keep acid off body.

In case of acid contact, wash immediately with water. In case of eye contact get prompt medical attention and wash eye with clean, cool water for at least 15 minutes.

If electrolyte is taken internally drink large quantities of water or milk! DO NOT induce vomiting. Get prompt medical attention.

W-2065-0807

Maintaining Battery Charge Level

All batteries will self-discharge over time. This machine has features that require battery power even when the machine is not being used. Use of a quality battery maintainer is highly recommended to ensure that your machine is ready to start when you need it and avoid costly battery replacement.

Battery Maintainers

Use a good quality battery maintainer to keep the battery above 12.4 volts for machines that are not frequently used. Batteries below 12.4 volts must first be charged using a battery charger. Solar maintainers should have a minimum capacity of 10 watts to be effective.

Battery Service During Machine Storage

Remove the battery if storing the machine for an extended period of time. Fully charge the battery. Store the battery in a cool dry place above freezing and boost charge periodically. If battery removal is not desired, a good quality battery maintainer must be used to compensate for battery self-discharge and parasitic loads from machine controllers, accessories, and features such as connected machine intelligence.

ELECTRICAL SYSTEM (CONT'D)

Battery Testing

Figure 226

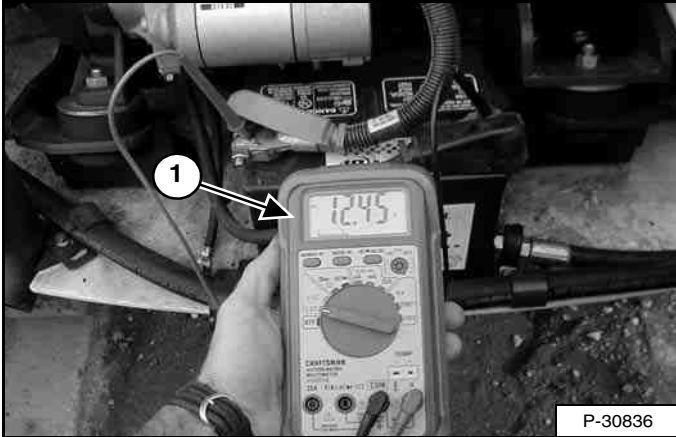

The simplest and most common check to determine battery state of charge is to use a digital multimeter or voltmeter (Item 1) [Figure 226].

A battery found below 12.4 volts must be charged to 100% charge per the battery charger's recommendation. **Allow at least 60 minutes after operating the machine or charging the battery to get an accurate reading.**

If the reading is less than 12.4 volts after the battery has been charged for several hours, see your Bobcat dealer to have a more thorough battery test performed.

The freezing point of battery electrolyte is dependent on the battery state of charge. Keeping the battery voltage above 12.4 volts will help prevent batteries from freezing, even at extremely low temperatures.

If the battery freezes, the internal grid may be damaged and the case will be distorted or cracked. If this happens, dispose of the battery according to local regulations.

Battery Charging

A battery charger designed for 12 volt charging systems is recommended. Follow the battery charger manufacturer's instructions to charge the battery to 12.6 volts (100% charge). Batteries should be charged at room temperature to avoid an undercharge or overcharge condition. Never attempt to charge a frozen battery.

The following table can be used to identify the approximate amount of time required to charge a discharged battery. Allow at least 60 minutes after operating the machine or charging the battery to get an accurate reading.

BATTERY VOLTAGE	STATE OF CHARGE	CHARGER MAXIMUM RATE		
		30 Amps	20 Amps	10 Amps
12.6 V	100%	READY TO USE		
12.4 V	75%	0.9 hr.	1.3 hr.	2.5 hr.
12.2 V	50%	1.9 hr.	2.7 hr.	5.1hr.
12.0 V	25%	2.9 hr.	4.3 hr.	7.8 hr.
11.8 V	0%	4.0 hr.	5.7 hr.	10.7 hr.

NOTE: Use a good quality automatic charger to avoid battery damage from overcharging.



BATTERY GAS CAN EXPLODE AND CAUSE SERIOUS INJURY OR DEATH

Keep arcs, sparks, flames and lighted tobacco away from batteries. When *jumping* from booster battery make final connection (negative) at machine frame.

Do not jump start or charge a frozen or damaged battery. Warm battery to 16°C (60°F) before connecting to a charger. Unplug charger before connecting or disconnecting cables to battery. Never lean over battery while boosting, testing or charging.

W-2066-0910

ELECTRICAL SYSTEM (CONT'D)

Using A Booster Battery (Jump Starting)

If the engine will not start without using a booster battery, BE CAREFUL! There must be one person in the operator's seat and one person to connect and disconnect the battery cables.

The key switch must be in the STOP position. The booster battery must be 12 volt.

WARNING

BATTERY GAS CAN EXPLODE AND CAUSE SERIOUS INJURY OR DEATH

Keep arcs, sparks, flames and lighted tobacco away from batteries. When *jumping* from booster battery make final connection (negative) at machine frame.

Do not jump start or charge a frozen or damaged battery. Warm battery to 16°C (60°F) before connecting to a charger. Unplug charger before connecting or disconnecting cables to battery. Never lean over battery while boosting, testing or charging.

W-2066-0910

Open the rear door.

Figure 227

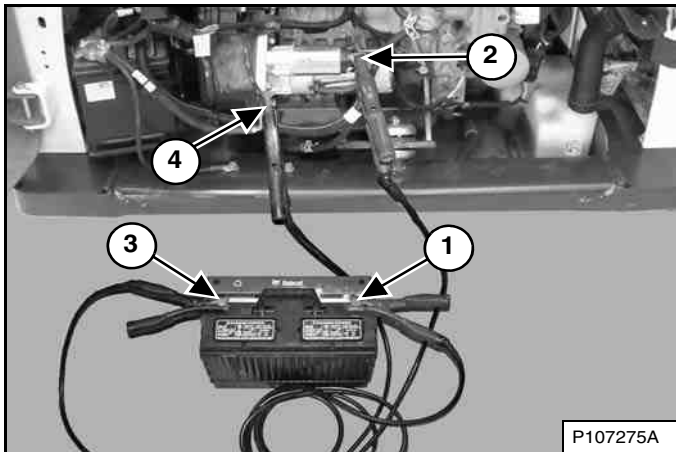

Connect the end of the first cable (Item 1) to the positive (+) terminal of the booster battery. Connect the other end of the same cable (Item 2) [Figure 227] to the positive (+) terminal on the engine starter.

Connect the end of the second cable (Item 3) to the negative (-) terminal of the booster battery. Connect the other end of the same cable (Item 4) [Figure 227] to the engine.

Keep cables away from moving parts. Start the engine. (See STARTING THE ENGINE on Page 96.)

After the engine has started, remove the negative (-) cable (Item 4) first. Remove the cable from the positive (+) terminal (Item 2) [Figure 227].

Remove the cables from the booster battery.

Close the rear door.

IMPORTANT

Damage to the alternator can occur if:

- Engine is operated with battery cables disconnected.
- Battery cables are connected when using a fast charger or when welding on the loader. (Remove both cables from the battery.)
- Extra battery cables (booster cables) are connected wrong.

I-2023-1285

ELECTRICAL SYSTEM (CONT'D)

Removing And Installing Battery



AVOID INJURY OR DEATH

Batteries contain acid which burns eyes and skin on contact. Wear goggles, protective clothing and rubber gloves to keep acid off body.

In case of acid contact, wash immediately with water. In case of eye contact get prompt medical attention and wash eye with clean, cool water for at least 15 minutes.

If electrolyte is taken internally drink large quantities of water or milk! DO NOT induce vomiting. Get prompt medical attention.

W-2065-0807

Stop the engine and open the rear door.

Figure 228

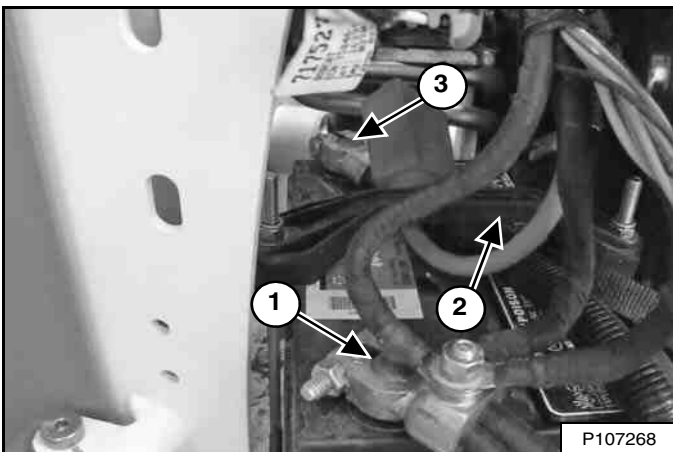

Disconnect the negative (-) cable (Item 1) [Figure 228].

Remove the battery hold-down clamp (Item 2) [Figure 228].

Disconnect the positive (+) cable (Item 3) [Figure 228] from the battery.

Remove the battery from the loader.

Figure 229

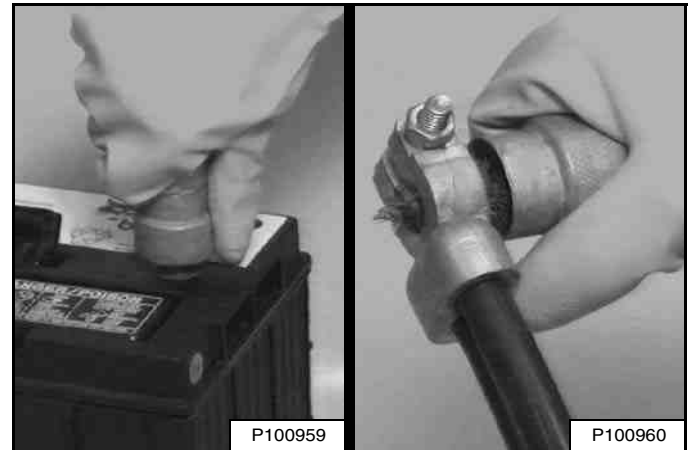

Always clean the battery terminals and cable ends when installing a new or used battery [Figure 229].

When installing the battery in the loader, do not touch any metal parts with the battery terminals.

Connect the negative (-) cable last to prevent sparks.

Connect and tighten the battery cables.

Install and tighten the battery hold-down clamp.

Put Bobcat Battery Saver or grease on the battery terminals and cable ends to prevent corrosion.

Close the rear door.



BATTERY GAS CAN EXPLODE AND CAUSE SERIOUS INJURY OR DEATH

Keep arcs, sparks, flames and lighted tobacco away from batteries. When *jumping* from booster battery make final connection (negative) at machine frame.

Do not jump start or charge a frozen or damaged battery. Warm battery to 16°C (60°F) before connecting to a charger. Unplug charger before connecting or disconnecting cables to battery. Never lean over battery while boosting, testing or charging.

W-2066-0910

HYDRAULIC / HYDROSTATIC SYSTEM

Checking And Adding Fluid

Check the hydraulic / hydrostatic fluid level every day before starting the work shift.

Park the loader on a level surface, lower the lift arms, and put the attachment flat on the ground or tilt the Bob-Tach fully back if no attachment is installed.

Stop the engine.

Figure 230

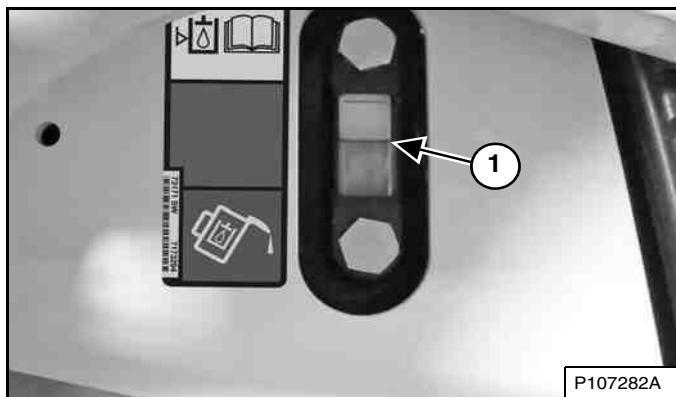

Check the fluid level in the sight gauge (Item 1) [Figure 230]. Keep the fluid level within the operating range.

Open the rear door and remove the rear grille. (See REAR GRILLE on Page 138.)

Figure 231



Remove the fill cap (Item 1) [Figure 231].

Add fluid as needed to bring the level within the operating range in the sight gauge [Figure 230].

Install the fill cap [Figure 231], install the rear grille, and close the rear door.

Hydraulic / Hydrostatic Fluid Chart

Figure 232

**HYDRAULIC / HYDROSTATIC FLUID
RECOMMENDED ISO VISCOSITY GRADE (VG)
AND VISCOSITY INDEX (VI)**

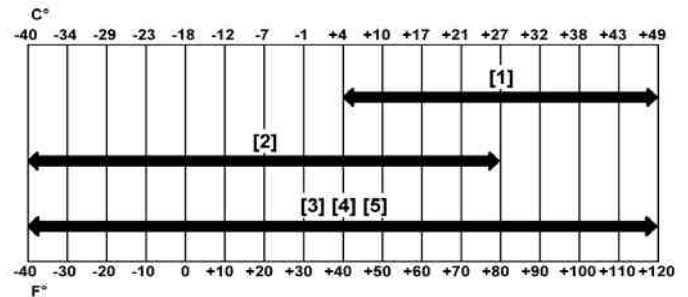

**TEMPERATURE RANGE ANTICIPATED
DURING MACHINE USE**

- [1] VG 100; Minimum VI 130
- [2] VG 46; Minimum VI 150
- [3] BOBCAT All-Season Fluid
- [4] BOBCAT Synthetic Fluid
- [5] BOBCAT Biodegradable Hydraulic / Hydrostatic Fluid (Unlike biodegradable fluids that are vegetable based, Bobcat biodegradable fluid is formulated to prevent oxidation and thermal breakdown at operating temperatures.)

Use only recommended fluid in the hydraulic system [Figure 232].



AVOID INJURY OR DEATH

Always clean up spilled fuel or oil. Keep heat, flames, sparks or lighted tobacco away from fuel and oil. Failure to use care around combustibles can cause explosion or fire.

W-2103-0508

HYDRAULIC / HYDROSTATIC SYSTEM (CONT'D)

Removing And Replacing Hydraulic Fluid

See the SERVICE SCHEDULE for the correct service interval. (See SERVICE SCHEDULE on Page 122.)

Replace the fluid if contaminated or after major repair.

Always replace the hydraulic / hydrostatic filter and the hydraulic charge filter whenever the hydraulic fluid is replaced. (See Removing And Replacing Hydraulic / Hydrostatic Filter on Page 165.) and (See Removing And Replacing Hydraulic Charge Filter on Page 166.)

Stop the engine, open the rear door, and remove the rear grille. (See REAR GRILLE on Page 138.)

Figure 233

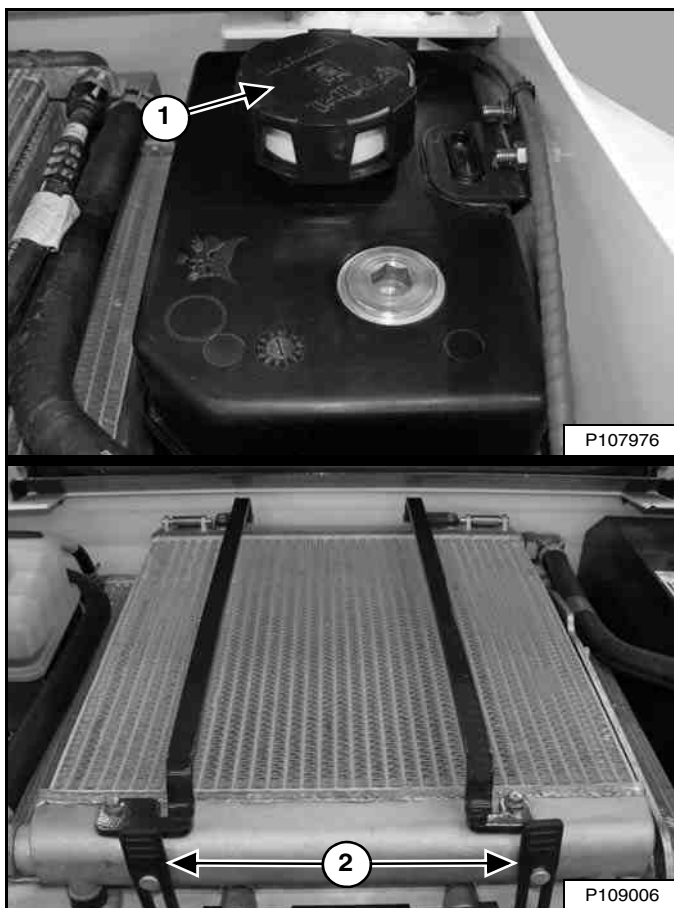

Remove the hydraulic fill cap (Item 1) [Figure 233].

(Earlier Models with Square Coolant Tank) - Unhook the two rubber straps (Item 2) [Figure 233].

Figure 234

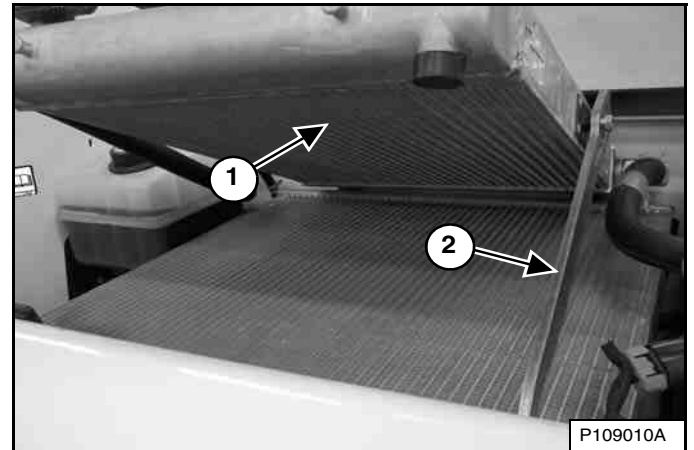

(Earlier Models with Square Coolant Tank) - Raise the hydraulic fluid cooler (Item 1) until the support bar (Item 2) [Figure 234] drops into position to support the hydraulic fluid cooler. This procedure will aid in draining the hydraulic fluid.

Figure 235

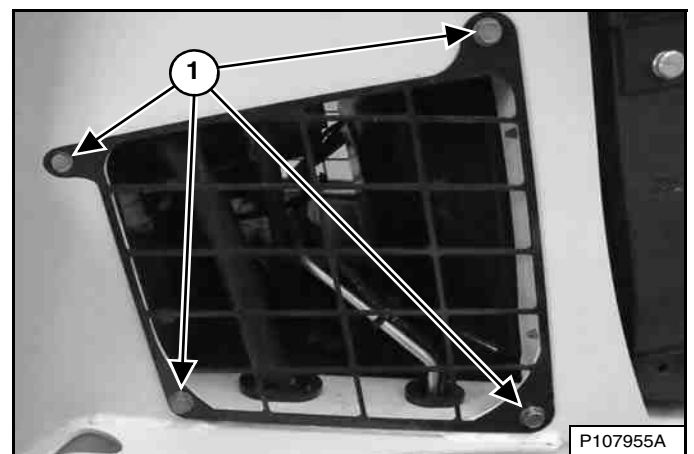

Remove the right side access cover bolts (Item 1) [Figure 235] and remove the access cover. (Lift arms shown raised for visual clarity.)

HYDRAULIC / HYDROSTATIC SYSTEM (CONT'D)

Removing And Replacing Hydraulic Fluid (Cont'd)

NOTE: The hose used to drain the hydraulic reservoir is located under the fan motor on earlier models and on the right side of the fan motor on later models.

Figure 236

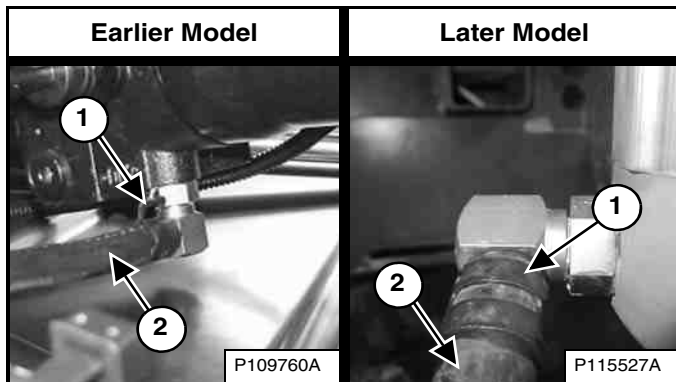

Remove the clamp (Item 1). Pinch off the hose (Item 2) [Figure 236] near the fitting and disconnect hose from the fitting. Route the hose out the side of the loader and drain the fluid into a container.

Connect the hose to the fitting when the fluid stops draining. Install the clamp.

Recycle or dispose of used fluid in an environmentally safe manner.

! WARNING

AVOID INJURY OR DEATH

Always clean up spilled fuel or oil. Keep heat, flames, sparks or lighted tobacco away from fuel and oil. Failure to use care around combustibles can cause explosion or fire.

W-2103-0508

Install the side access cover and bolts [Figure 235].

(Earlier Models with Square Coolant Tank) - Raise the support bar supporting the hydraulic fluid cooler and lower the hydraulic fluid cooler. Fasten the two rubber straps [Figure 233].

Figure 237

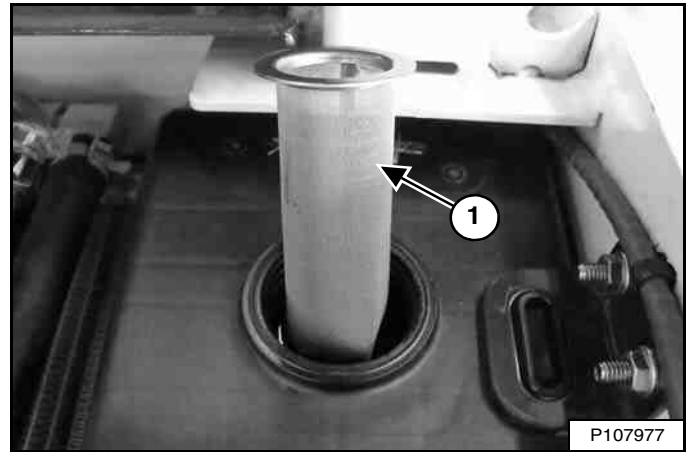

Remove and clean the hydraulic fill screen (Item 1) [Figure 237]. Use low air pressure to dry the screen.

Install hydraulic fill screen and add the correct fluid to the reservoir until the fluid level is within the operating range of the sight gauge. (See Capacities on Page 204.) and (See Checking And Adding Fluid on Page 162.)

Install the hydraulic fill cap [Figure 233].

Install the rear grille and close the rear door.

Start the engine and operate the loader hydraulic controls.

! WARNING

AVOID INJURY OR DEATH

Diesel fuel or hydraulic fluid under pressure can penetrate skin or eyes, causing serious injury or death. Fluid leaks under pressure may not be visible. Use a piece of cardboard or wood to find leaks. Do not use your bare hand. Wear safety goggles. If fluid enters skin or eyes, get immediate medical attention from a doctor familiar with this injury.

W-2072-EN-0909

Stop the engine and check for leaks.

Check the fluid level in the reservoir and add as needed. (See Checking And Adding Fluid on Page 162.)

HYDRAULIC / HYDROSTATIC SYSTEM (CONT'D)

Removing And Replacing Hydraulic / Hydrostatic Filter

See the SERVICE SCHEDULE for the correct service interval. (See SERVICE SCHEDULE on Page 122.)

Stop the engine, open the rear door, and remove the rear grille. (See REAR GRILLE on Page 138.)

Clean the top of the filter housing.

Figure 238

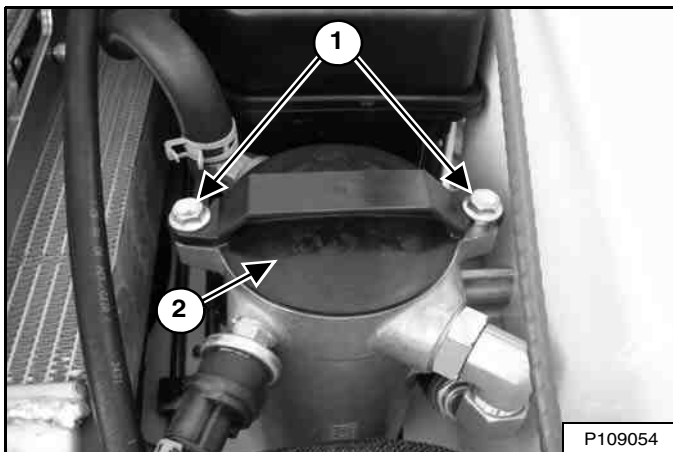

Loosen the bolts (Item 1) and rotate the filter cap (Item 2) [Figure 238] anticlockwise until the cap clears the bolts.

Slowly pry the filter cap off the housing by hand.

Figure 239

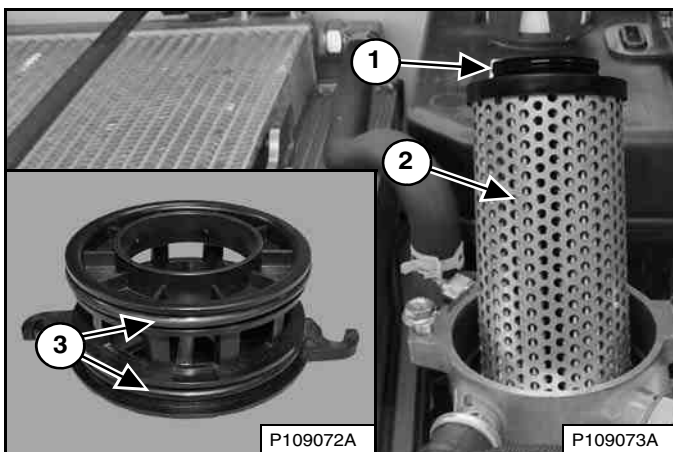

Remove the filter (Item 2) [Figure 239] and discard.

Lubricate the O-ring (Item 1) [Figure 239] on new filter with clean oil.

Install new filter ensuring that filter is fully seated in the housing.

Remove the filter cap O-rings (Item 3) [Figure 239] and discard.

Install new filter cap O-rings and lubricate with clean oil.

NOTE: The filter cap O-rings are not the same size. Take care to install each O-ring in the correct location.

Install the filter cap and rotate clockwise to engage the bolts [Figure 238]. Alternate tightening the bolts to draw the cap down evenly. Tighten the bolts to 27 - 41 N•m (20 - 30 ft-lb) torque.

WARNING

AVOID INJURY OR DEATH

Always clean up spilled fuel or oil. Keep heat, flames, sparks or lighted tobacco away from fuel and oil. Failure to use care around combustibles can cause explosion or fire.

W-2103-0508

Install the rear grille and close the rear door.

Start the engine and operate the loader hydraulic controls.

WARNING

AVOID INJURY OR DEATH

Diesel fuel or hydraulic fluid under pressure can penetrate skin or eyes, causing serious injury or death. Fluid leaks under pressure may not be visible. Use a piece of cardboard or wood to find leaks. Do not use your bare hand. Wear safety goggles. If fluid enters skin or eyes, get immediate medical attention from a doctor familiar with this injury.

W-2072-EN-0909

Stop the engine and check for leaks at the filter.

Check the fluid level in the reservoir and add as needed. (See Checking And Adding Fluid on Page 162.)

HYDRAULIC / HYDROSTATIC SYSTEM (CONT'D)

Removing And Replacing Hydraulic Charge Filter

See the SERVICE SCHEDULE for the correct service interval. (See SERVICE SCHEDULE on Page 122.)

Figure 240

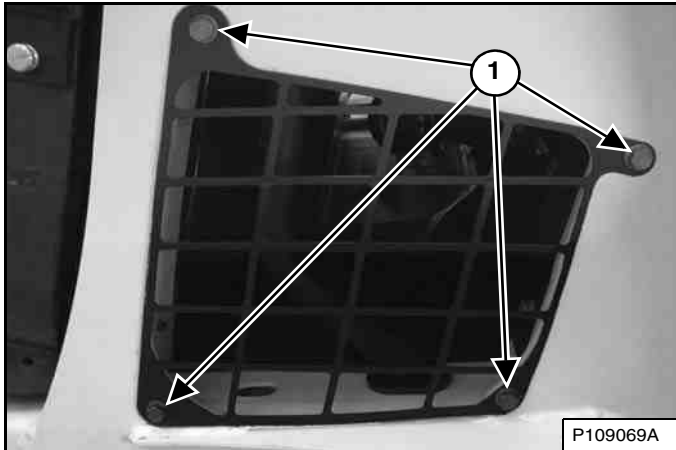

Remove the left side access cover bolts (Item 1) [Figure 240] and remove the access cover. (Lift arms shown raised for visual clarity.)

NOTE: Identification of the hydraulic charge filter used on your machine is necessary to perform the correct replacement procedure.

Figure 241

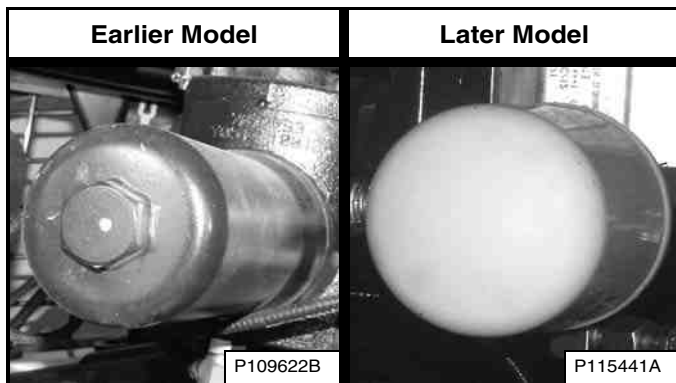

Earlier models use a separate filter housing and filter element. Later models use a spin-on filter [Figure 241].

Earlier Models

Figure 242

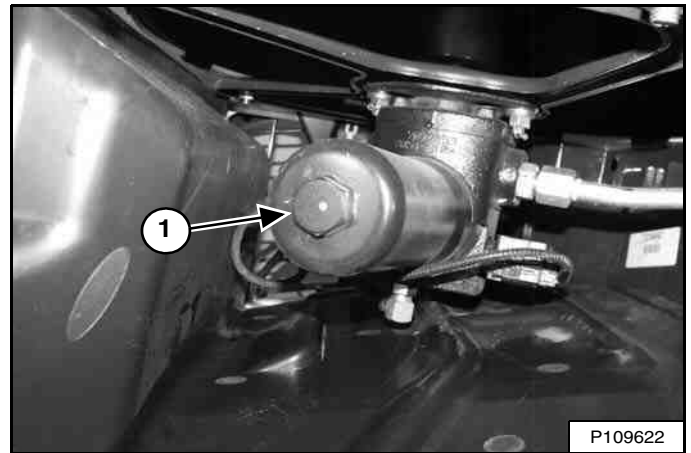

Put a suitable container below the filter housing and remove the filter housing (Item 1) [Figure 242].

Figure 243

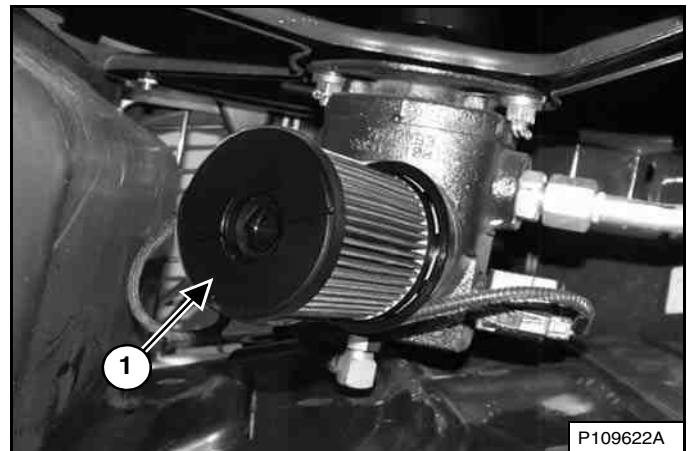

Remove the filter (Item 1) [Figure 243] and discard.

Clean the surface of the filter housing and the filter base where they contact the filter seal.

Put clean oil on the seal of the new filter. Install the filter on the filter base [Figure 243].

Install and tighten the filter housing to 65 - 70 N•m (48 - 52 ft-lb) torque [Figure 242].

HYDRAULIC / HYDROSTATIC SYSTEM (CONT'D)

Removing And Replacing Hydraulic Charge Filter (Cont'd)

Later Models

Figure 244

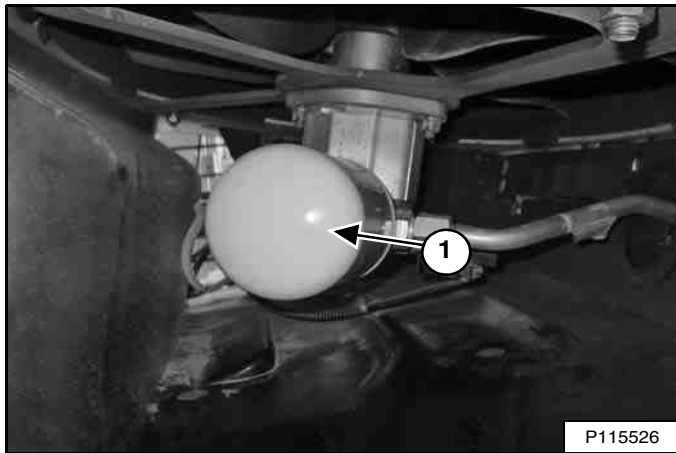

Put a suitable container below the filter, remove the filter (Item 1) [Figure 244], and clean the filter base.

Put clean oil on the new filter gasket, install the new filter, and tighten the filter to 37 – 45 N•m (27 – 33 ft-lb) torque.

All Models

Recycle or dispose of used fluid in an environmentally safe manner.

! WARNING

AVOID INJURY OR DEATH

Always clean up spilled fuel or oil. Keep heat, flames, sparks or lighted tobacco away from fuel and oil. Failure to use care around combustibles can cause explosion or fire.

W-2103-0508

Install the side access cover and bolts [Figure 240].

Start the engine and operate the loader hydraulic controls.

! WARNING

AVOID INJURY OR DEATH

Diesel fuel or hydraulic fluid under pressure can penetrate skin or eyes, causing serious injury or death. Fluid leaks under pressure may not be visible. Use a piece of cardboard or wood to find leaks. Do not use your bare hand. Wear safety goggles. If fluid enters skin or eyes, get immediate medical attention from a doctor familiar with this injury.

W-2072-EN-0909

Stop the engine and check for leaks at the filter.

Check the fluid level in the reservoir and add as needed. (See Checking And Adding Fluid on Page 162.)

HYDRAULIC / HYDROSTATIC SYSTEM (CONT'D)

Replacing Reservoir Breather Cap

See the SERVICE SCHEDULE for the correct replacement interval. (See SERVICE SCHEDULE on Page 122.)

Stop the engine, open the rear door, and remove the rear grille. (See REAR GRILLE on Page 138.)

Figure 245

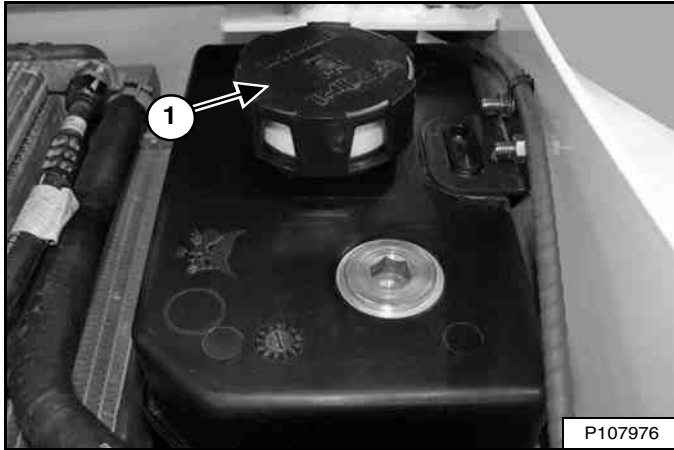

Remove the breather cap (Item 1) [Figure 245] and discard.

Install new breather cap.

Install the rear grille and close the rear door.

SPARK ARRESTER MUFFLER

Cleaning Procedure

See the SERVICE SCHEDULE for the correct service interval. (See SERVICE SCHEDULE on Page 122.)

Do not operate the loader with a defective exhaust system.

IMPORTANT

This machine is factory equipped with a spark arrester exhaust system that must be maintained for proper function.

- **WITH MUFFLER**
The muffler chamber must be emptied every 100 hours of operation to keep it in working condition.
- **WITH SELECTIVE CATALYST REDUCTION (SCR) AND / OR DIESEL OXIDATION CATALYST (DOC)**
Do not remove or modify the DOC or SCR.

The SCR must be maintained according to the instructions in the Operation & Maintenance Manual for proper function.
- **WITH DIESEL PARTICULATE FILTER (DPF)**
The DPF must be maintained according to the instructions in the Operation & Maintenance Manual for proper function.

(If this machine is operated on flammable forest, brush or grass cover land, a spark arrester attached to the exhaust system may be required and must be maintained in working order. Refer to local laws and regulations for spark arrester requirements.)

I-2350-EN-1114

Stop the engine and open the rear door.

! WARNING

AVOID INJURY OR DEATH

When an engine is running in an enclosed area, fresh air must be added to avoid concentration of exhaust fumes. If the engine is stationary, vent the exhaust outside. Exhaust fumes contain odorless, invisible gases which can kill without warning.

W-2050-0807

! WARNING

Never use machine in atmosphere with explosive dust or gases or where exhaust can contact flammable material. Failure to obey warnings can cause injury or death.

W-2068-1285

! WARNING

Stop engine and allow the muffler to cool before cleaning the spark chamber. Wear safety goggles. Failure to obey can cause serious injury.

W-2011-1285

Figure 246

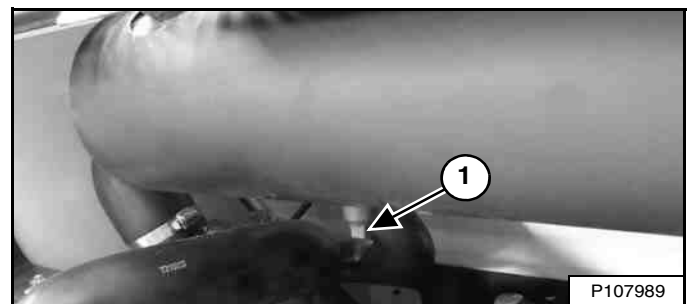

Remove the plug (Item 1) [Figure 246] from the muffler.

! WARNING

When the engine is running during service, the driving and steering controls must be in neutral and the parking brake engaged. Failure to do so can cause injury or death.

W-2006-1209

Start the engine and operate for approximately 10 seconds while a second person, wearing safety glasses, holds a piece of wood over the outlet of the muffler. This will force contaminants out through the cleanout hole.

Stop the engine. Install and tighten the plug. Close the rear door.

TYRE MAINTENANCE

Wheel Nuts

See the SERVICE SCHEDULE for the correct service interval. (See SERVICE SCHEDULE on Page 122.)

Figure 247



Follow the torques specified below for the wheel nuts [Figure 247]:

When *installing* wheel nuts, tighten to 217 N•m (160 ft-lb) torque.

When *checking* wheel nut torque, set the torque wrench to 190 N•m (140 ft-lb) to prevent overtightening.

Rotating

Check the tyres regularly for wear, damage, and pressure.

Figure 248

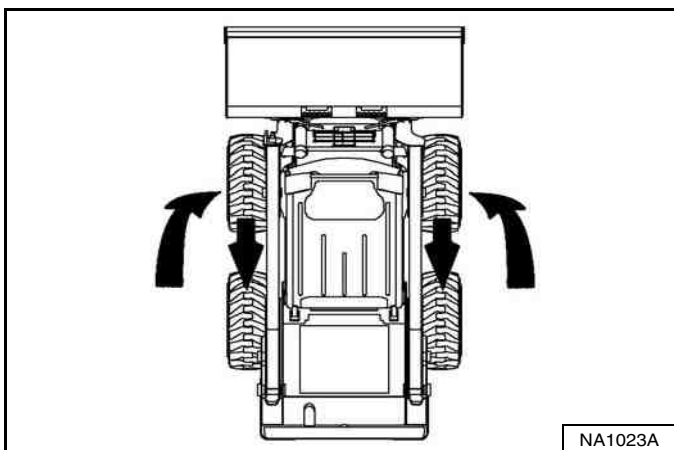

Rear tyres usually wear faster than front tyres. To keep tyre wear even, move the front tyres to the rear and rear tyres to the front [Figure 248].

The same size tyres must be used on each side of the loader. If different sizes are used, each tyre will turn at a different rate and cause excessive wear. The tread bars of all the tyres must face the same direction.

Recommended tyre pressure must be maintained to avoid excessive tyre wear, loss of stability, and loss of handling capability. Check for correct pressure before operating the loader. (See Tyres on Page 205.)

Mounting

Tyres are to be repaired only by an authorised person using the proper procedures and safe equipment.

Tyres and rims must always be checked for correct size before mounting. Check rim and tyre bead for damage.

The rim flange must be cleaned and free of rust.

The tyre bead and rim flange must be lubricated with a rubber lubricant before mounting the tyre.

Avoid excessive pressure that can rupture the tyre and cause serious injury or death.

During inflation of the tyre, check the tyre pressure frequently to avoid over inflation.

WARNING

AVOID INJURY OR DEATH

Do not inflate tyres above specified pressure. Failure to use correct tyre mounting procedure can cause an explosion which can result in injury or death.

W-2078-EN-0909

IMPORTANT

Inflate tyres to the **MAXIMUM** pressure shown on the sidewall of the tyre. **DO NOT** mix brands of tyres used on the same machine.

I-2057-EN-1010

FINAL DRIVE TRANSMISSION (CHAINCASE)

Checking And Adding Fluid

See the SERVICE SCHEDULE for the correct service interval. (See SERVICE SCHEDULE on Page 122.)

The chaincase contains the final drive sprockets and chains, and uses the same type fluid as the hydraulic / hydrostatic system. (See Hydraulic / Hydrostatic Fluid Chart on Page 162.)

Park the loader on a level surface and stop the engine.

Figure 249

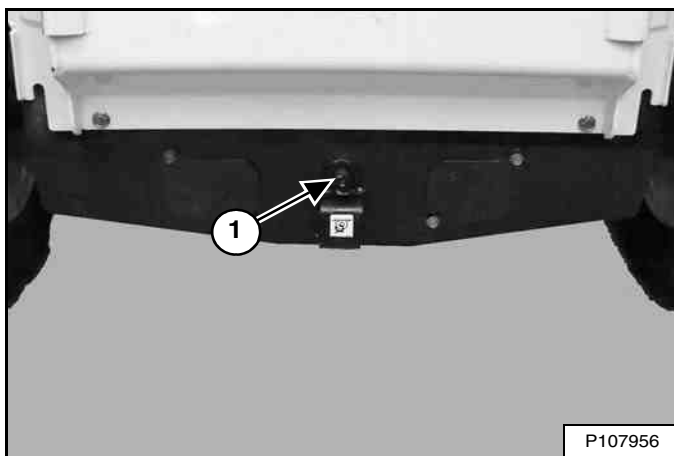

Remove the check plug (Item 1) [Figure 249] from the front of the chaincase housing. (Lift arms shown raised for visual clarity.)

If fluid can be reached with the tip of your finger through the hole, the fluid level is correct.

If the level is low, add fluid through the check plug hole until fluid flows from the hole.

Install and tighten the plug [Figure 249].

WARNING

AVOID INJURY OR DEATH

Always clean up spilled fuel or oil. Keep heat, flames, sparks or lighted tobacco away from fuel and oil. Failure to use care around combustibles can cause explosion or fire.

W-2103-0508

Removing And Replacing Fluid

See the SERVICE SCHEDULE for the correct service interval. (See SERVICE SCHEDULE on Page 122.)

Park the loader on a level surface and stop the engine.

Remove the check plug (Item 1) [Figure 249] from the front of the chaincase housing.

Figure 250

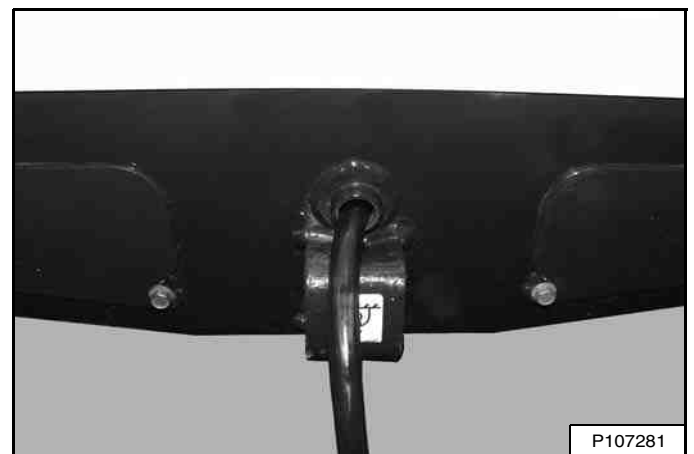

Pump the fluid out of the chaincase [Figure 250]. (Lift arms shown raised for visual clarity.)

Recycle or dispose of used fluid in an environmentally safe manner.

Add fluid through the check plug hole until fluid flows from the hole. (See Capacities on Page 204.)

Install and tighten the plug [Figure 249].

WARNING

AVOID INJURY OR DEATH

Always clean up spilled fuel or oil. Keep heat, flames, sparks or lighted tobacco away from fuel and oil. Failure to use care around combustibles can cause explosion or fire.

W-2103-0508

ALTERNATOR BELT

Belt Adjustment

Stop the engine and open the rear door.

Figure 251

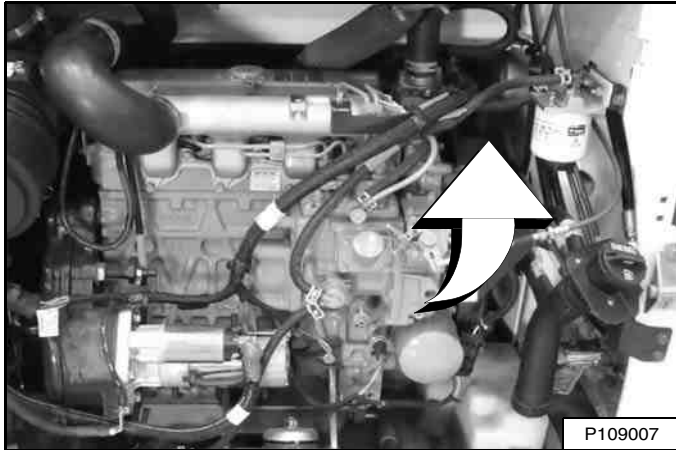

The alternator is located behind the engine on the right side of the loader **[Figure 251]**.

Figure 252

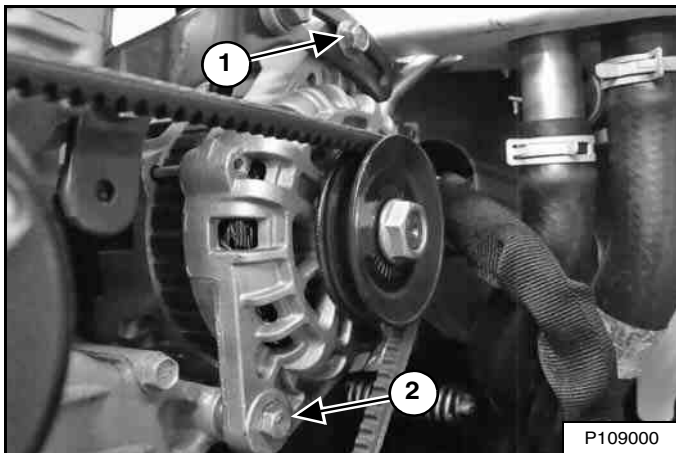

Loosen the top alternator adjusting bolt (Item 1) and loosen the bottom alternator mounting bolt (Item 2) **[Figure 252]**.

Move the alternator until the belt has 8 mm (0.32 in) movement at the middle of the belt span with 66 N (15 lb) of force.

Tighten the top alternator adjusting bolt (Item 1) and the bottom alternator mounting bolt (Item 2) **[Figure 252]**.

Close the rear door.

Belt Replacement

Stop the engine and open the rear door.

Figure 253

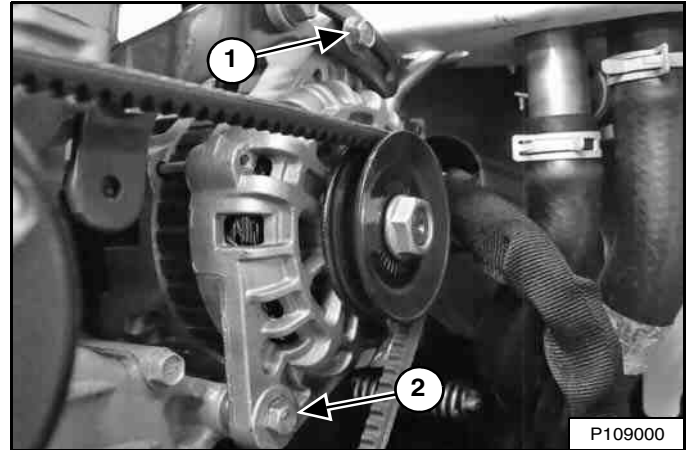

Loosen the bottom alternator mounting bolt (Item 2) and remove the top alternator adjusting bolt (Item 1) **[Figure 253]**.

Move the alternator toward the engine fully and remove the belt from the pulleys.

Inspect the pulleys for wear.

Install new belt.

Install the top alternator adjusting bolt (Item 1) **[Figure 253]**.

Move the alternator until the belt has 8 mm (0.32 in) movement at the middle of the belt span with 66 N (15 lb) of force.

Tighten the top alternator adjusting bolt (Item 1) and the bottom alternator mounting bolt (Item 2) **[Figure 253]**.

Close the rear door.

DRIVE BELT

Belt Adjustment

See the SERVICE SCHEDULE for the correct service interval. (See SERVICE SCHEDULE on Page 122.)

Stop the engine and open the rear door.

Figure 254

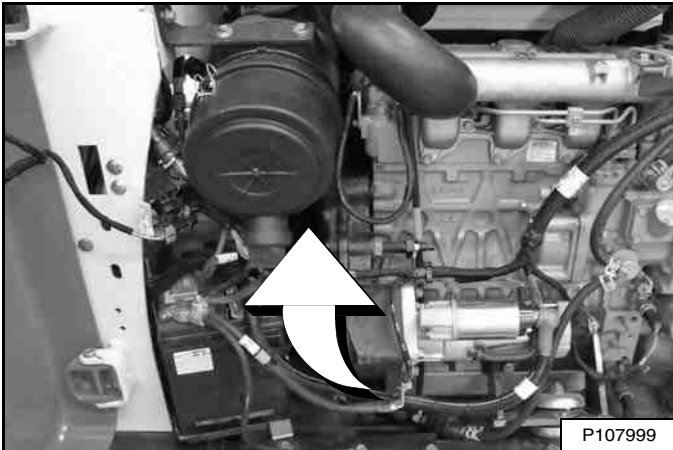

The spring loaded drive idler is located below the air cleaner [Figure 254].

Inspection

Figure 255

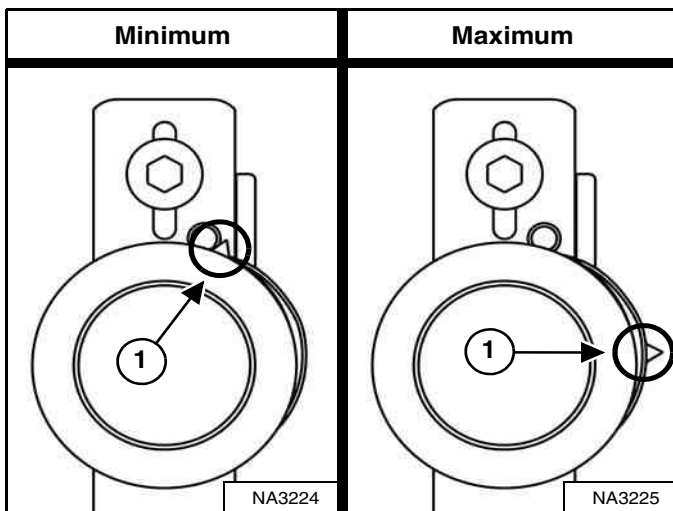

The pointer (Item 1) [Figure 255] on the spring loaded drive idler must be maintained between the two positions shown for correct belt tension.

Adjustment

Figure 256

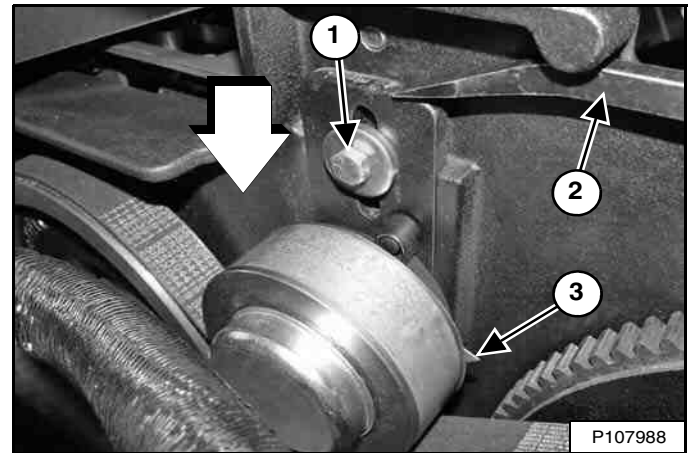

Loosen the spring loaded drive idler mounting bolt (Item 1) [Figure 256].

Push the spring loaded drive idler against the belt using a pry bar (Item 2). The pointer will be at the 90 degree position (Item 3) [Figure 256] when the idler is against the stop.

Allow the spring loaded drive idler to raise slightly so that the idler is operating on spring tension and not against the stop.

NOTE: Do not set the spring loaded drive idler against the travel stop.

Tighten the spring loaded drive idler mounting bolt (Item 1) [Figure 256] to 48 - 54 N•m (35 - 40 ft-lb) torque.

Close the rear door.

DRIVE BELT (CONT'D)

Belt Replacement

Stop the engine and open the rear door.

Figure 257

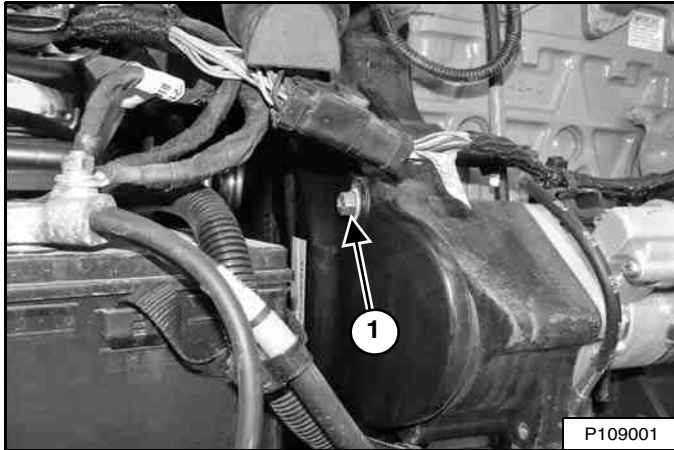

Remove the drive belt shield bolt (Item 1) [Figure 257].

Figure 258

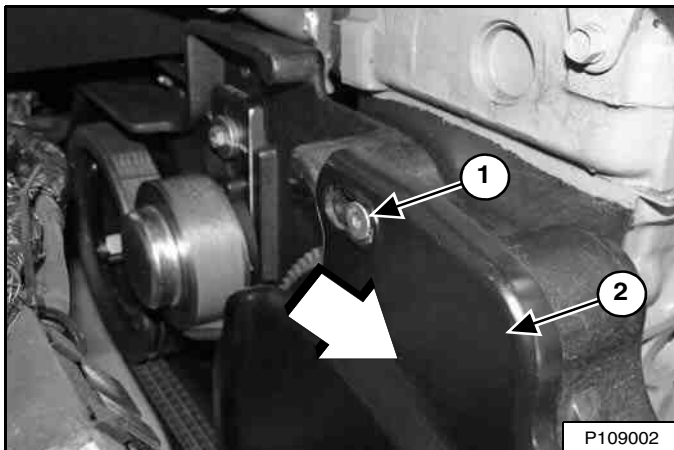

Do **NOT** loosen the drive belt shield mounting bolts (top bolt shown) (Item 1). Slide the drive belt shield (Item 2) [Figure 258] toward the back of the loader to unseat the shield from the top and bottom drive belt shield mounting bolts.

Remove the drive belt shield (Item 2) [Figure 258].

Figure 259

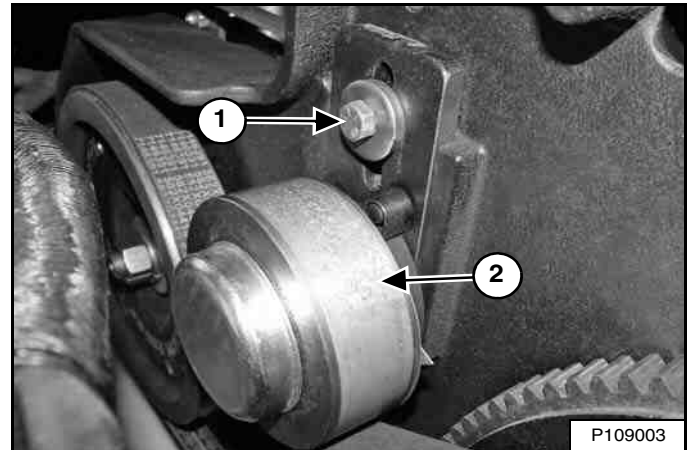

Loosen the spring loaded drive idler mounting bolt (Item 1) and allow the idler (Item 2) [Figure 259] to move up. Remove the mounting bolt, washer, and idler assembly.

Remove the drive belt from the hydrostatic pump pulley and flywheel pulley. Inspect the pulleys for wear.

Install new drive belt.

Apply Loctite® 242 to the mounting bolt. Install the spring loaded drive idler, washer, and mounting bolt [Figure 259].

DRIVE BELT (CONT'D)

Belt Replacement (Cont'd)

Figure 260

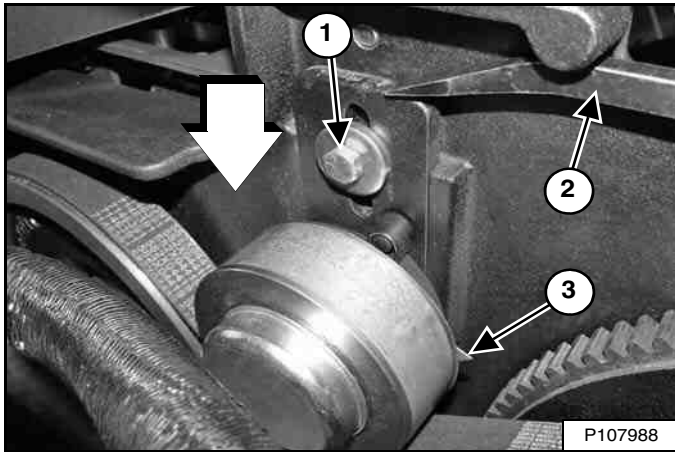

Push the spring loaded drive idler against the belt using a pry bar (Item 2). The pointer will be at the 90 degree position (Item 3) [Figure 260] when the idler is against the stop.

Allow the spring loaded drive idler to raise slightly so that the idler is operating on spring tension and not against the stop.

NOTE: Do not set the spring loaded drive idler against the travel stop.

Tighten the spring loaded drive idler mounting bolt (Item 1) [Figure 260] to 48 - 54 N•m (35 - 40 ft-lb) torque.

Figure 261

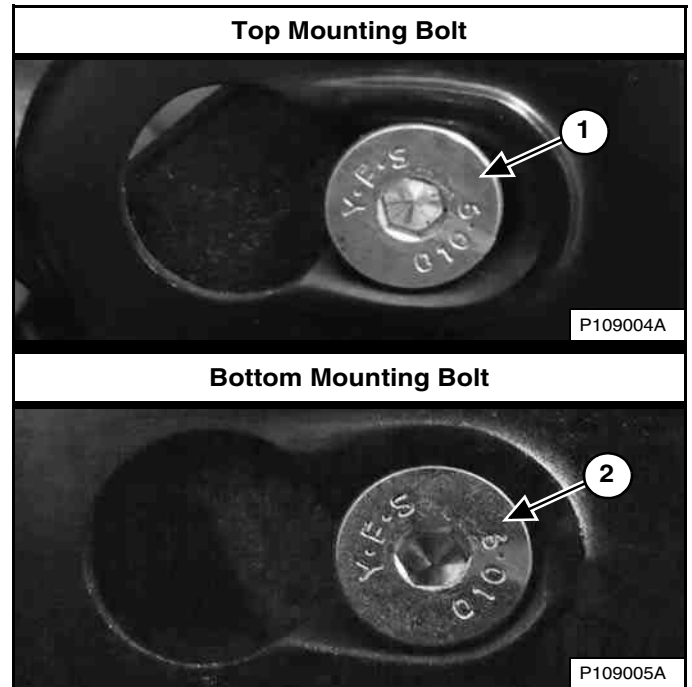

Position the drive belt shield over the drive belt shield mounting bolts. Slide the drive belt shield toward the front of the loader to fully seat the shield onto the top and bottom mounting bolts (Items 1 and 2) [Figure 261].

Figure 262

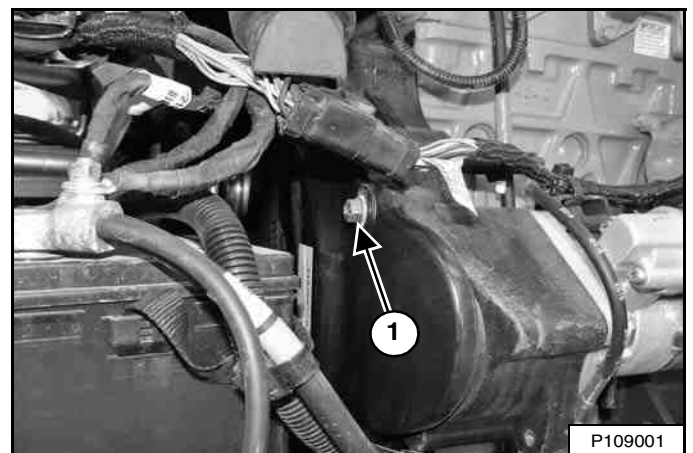

Install the drive belt shield bolt (Item 1) [Figure 262].

Close the rear door.



AUTOMATIC RIDE CONTROL ACCUMULATOR

Checking Accumulator Charge

This machine may be equipped with Automatic Ride Control.

The nitrogen charge in your accumulator will decrease over time. This will result in decreased effectiveness of the automatic ride control benefits.

NOTE: The signs of a low accumulator charge include: excessive lift arm movement, reduced ride control performance, or loss of ride control function.

Special tools and equipment are required to check and service the nitrogen charge in the accumulator.

WARNING

**RIDE CONTROL ACCUMULATOR INSTALLED
PRESSURISED FLUID CAN CAUSE SERIOUS INJURY**
After fully lowering the lift arms or installing an approved lift arm support device, use lift arm bypass control for 5 seconds to release pressure from lift circuit before servicing.

See Operation & Maintenance Manual or Service Manual for lift arm bypass control instructions.

W-3015-EN-0816

See your Bobcat dealer for service if you believe that your automatic ride control accumulator charge is low.

LUBRICATING THE LOADER

Lubrication Locations

See the SERVICE SCHEDULE for the correct service interval. (See SERVICE SCHEDULE on Page 122.)

Record the operating hours each time you lubricate the Bobcat loader.

Always use a good quality lithium based multipurpose grease when you lubricate the loader. Apply the lubricant until extra grease shows.

Remove attachment from the loader. (See Installing And Removing The Attachment (Hand Lever Bob-Tach) on Page 107.) **OR** (See Installing And Removing The Attachment (Power Bob-Tach) on Page 110.)

Stop the engine.

Figure 263

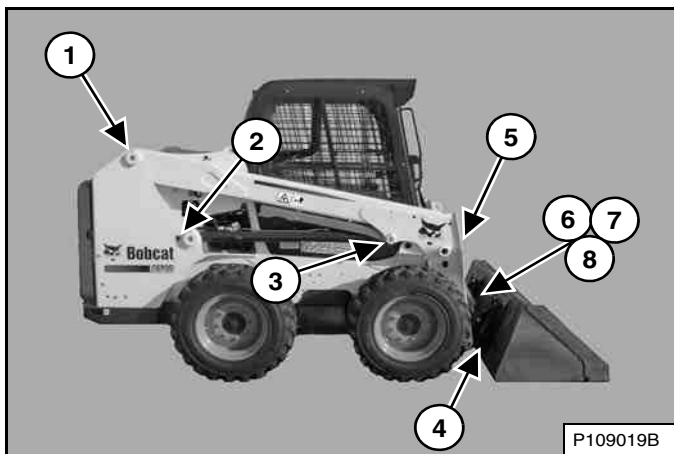

The grease fitting locations [Figure 263] are shown in more detail in the following figures.

Lubricate the following:

Figure 264

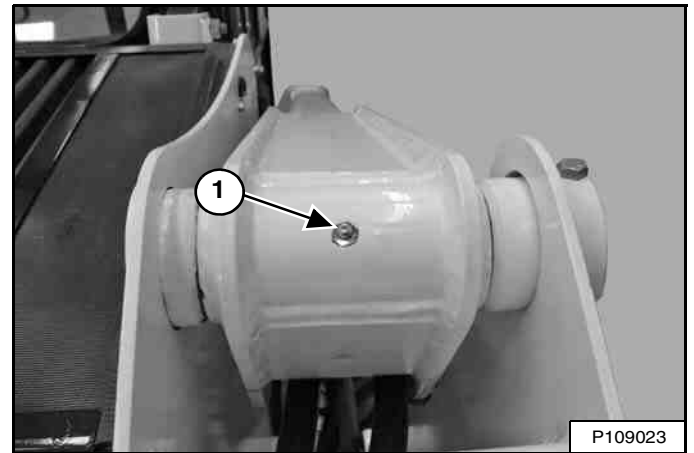

1. Lift Arm Pivot Pin (Both Sides) (2) [Figure 264].

Figure 265

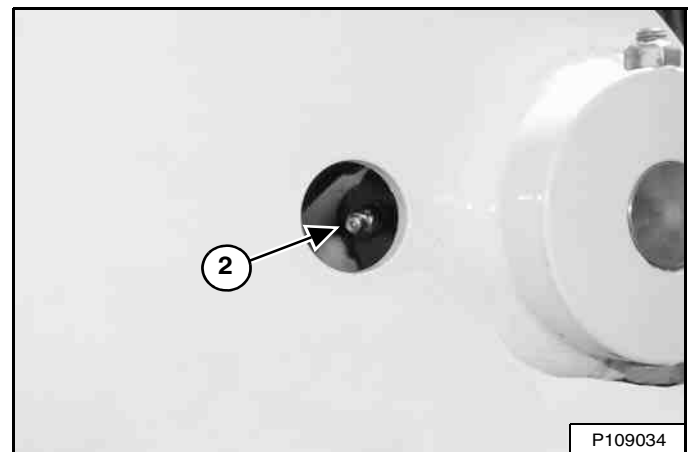

2. Base End Lift Cylinder (Both Sides) (2) [Figure 265].

LUBRICATING THE LOADER (CONT'D)

Lubrication Locations (Cont'd)

Figure 266

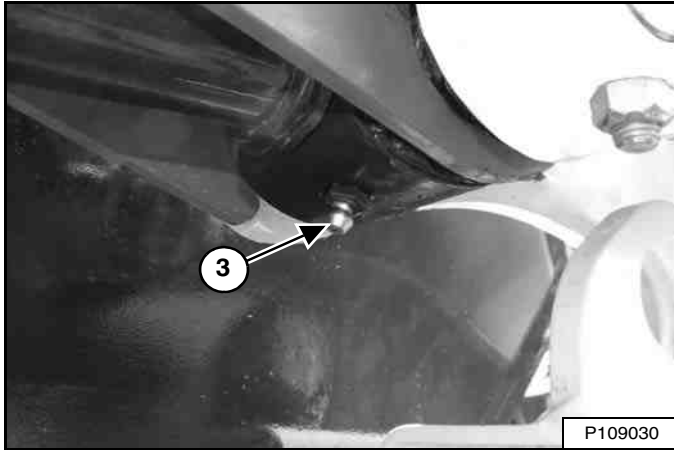

3. Rod End Lift Cylinder (Both Sides) (2) [Figure 266].

Figure 267

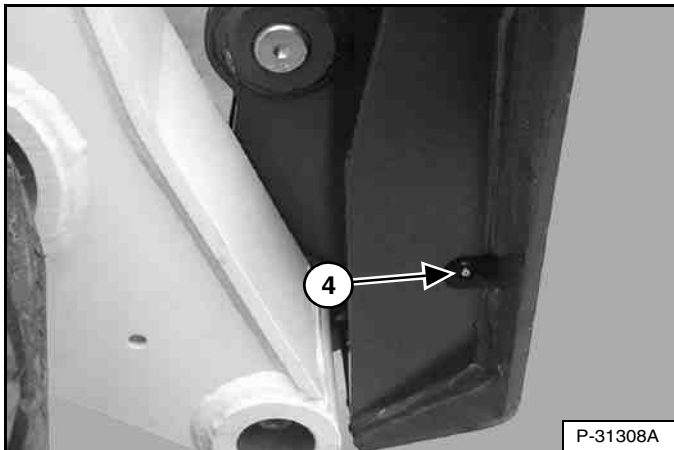

4. Bob-Tach Wedge (Both Sides) (2) [Figure 267].

Figure 268

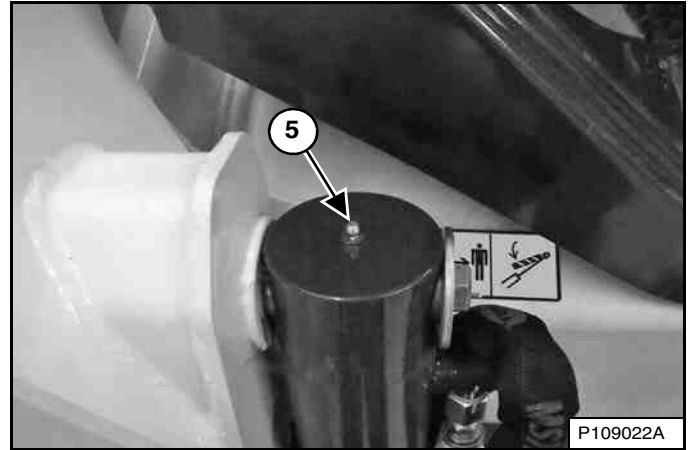

5. Base End Tilt Cylinder (Both Sides) (2) [Figure 268].

Figure 269

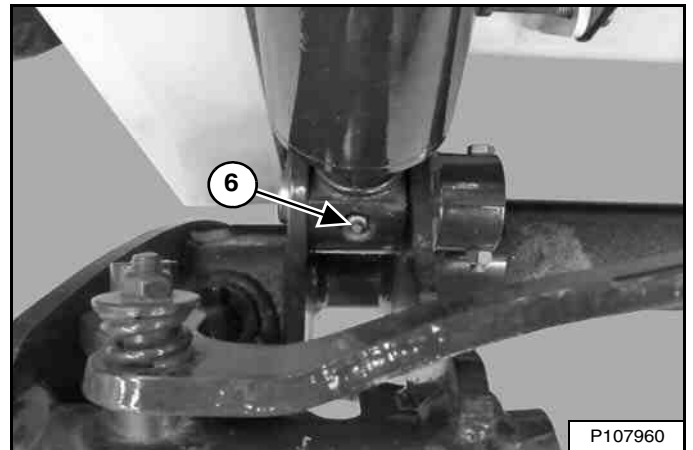

6. Rod End Tilt Cylinder (Both Sides) (2) [Figure 269].

LUBRICATING THE LOADER (CONT'D)

Lubrication Locations (Cont'd)

Figure 270

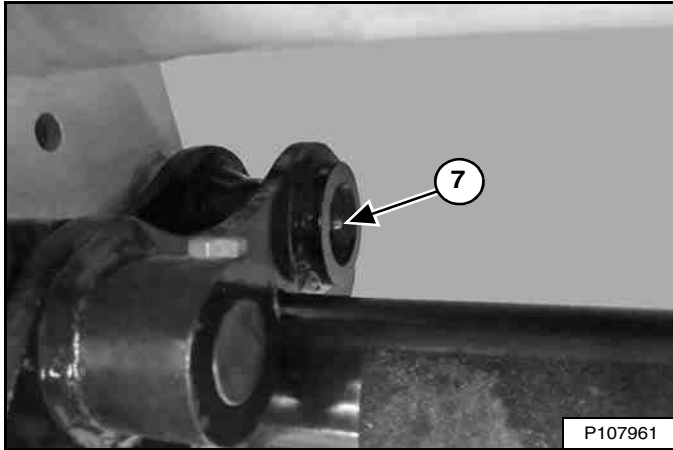

7. Bob-Tach Pivot Pin (Both Sides) (2) [Figure 270].

If Equipped With Power Bob-Tach

Figure 271

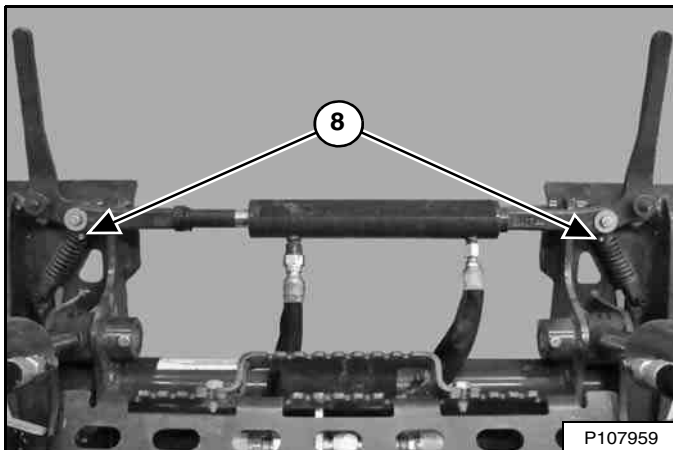

8. Power Bob-Tach Hydraulic Cylinder (2) [Figure 271].

PIVOT PINS

Inspection And Maintenance

Figure 272

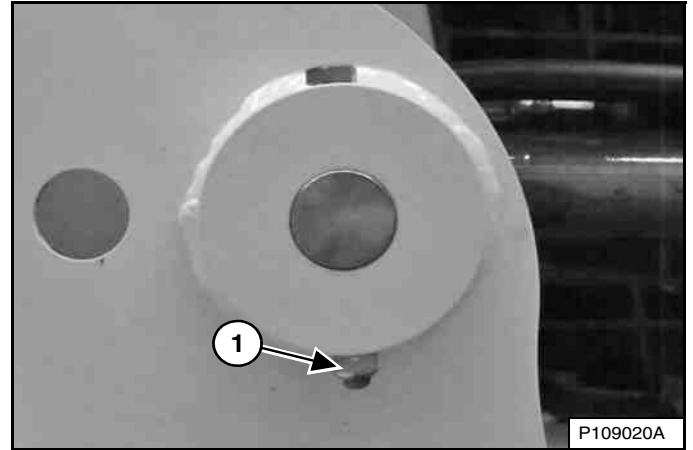

All lift arm and cylinder pivots have a large pin held in position with a retainer bolt and locknut (Item 1) [Figure 272].

Check that the locknuts are tightened to 48 - 54 N•m (35 - 40 ft-lb) torque.

BOB-TACH (HAND LEVER)

Inspection And Maintenance

Figure 273

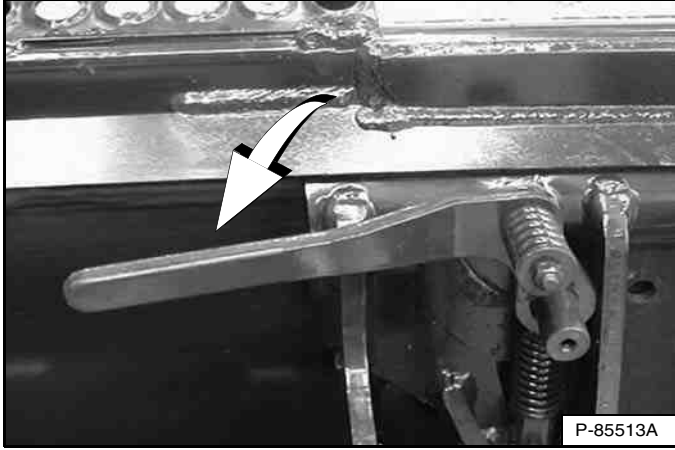

Move the Bob-Tach levers down to engage the wedges [Figure 273].

The levers and wedges must move freely.



AVOID INJURY OR DEATH

The Bob-Tach wedges must extend through the holes in the attachment mounting frame. Levers must be fully down and locked. Failure to secure wedges can allow attachment to come off.

W-2715-0208

Figure 274

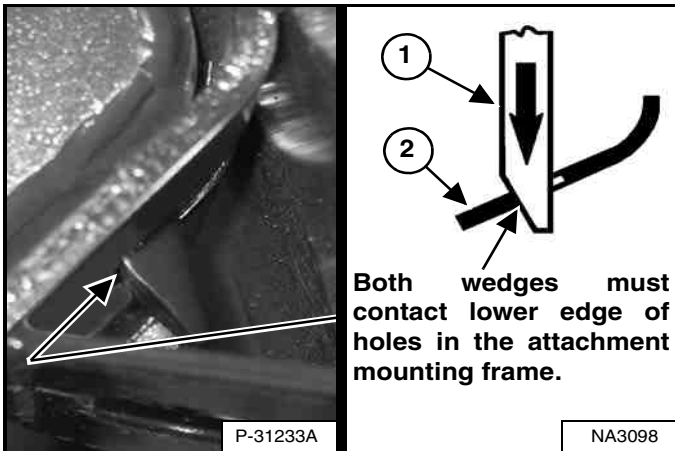

The wedges (Item 1) [Figure 274] must extend through the holes in the attachment mounting frame.

The spring loaded wedges (Item 1) must contact the lower edge of the holes in the attachment mounting frame (Item 2) [Figure 274].

If the wedges do not contact the lower edge of the holes [Figure 274], the attachment will be loose and can come off the Bob-Tach.

Figure 275

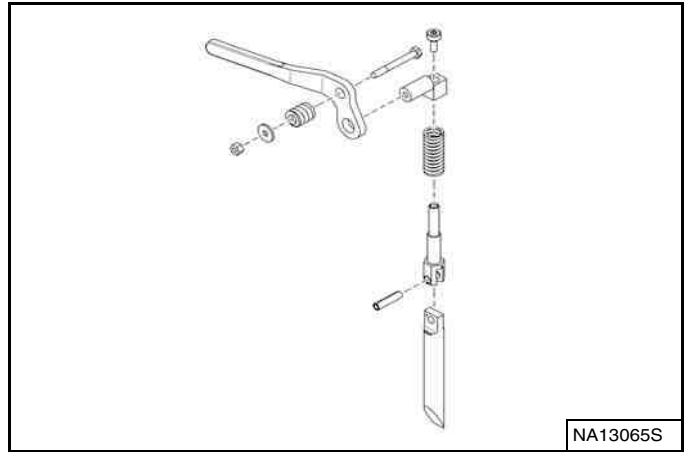

Inspect the mounting frame on the attachment and Bob-Tach, linkages, and wedges for excessive wear or damage [Figure 275]. Replace any parts that are damaged, bent, or missing. Keep all fasteners tight.

Look for cracked welds. Contact your Bobcat dealer for repair or replacement parts.

Lubricate the wedges. (See SERVICE SCHEDULE on Page 122.) and (See LUBRICATING THE LOADER on Page 177.)

BOB-TACH (POWER)

This machine may be equipped with a Power Bob-Tach.

Inspection And Maintenance

Figure 276

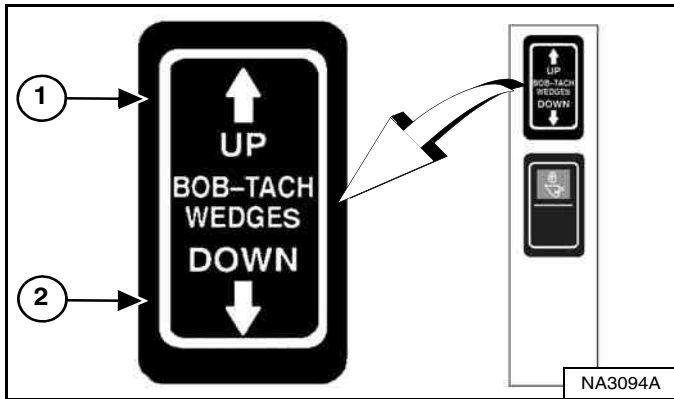

Push and hold the BOB-TACH WEDGES “UP” switch (Item 1) until wedges are fully raised. Push and hold the BOB-TACH WEDGES “DOWN” switch (Item 2) [Figure 276] until the wedges are fully down.

The levers and wedges must move freely.



AVOID INJURY OR DEATH

The Bob-Tach wedges must extend through the holes in the attachment mounting frame. Levers must be fully down and locked. Failure to secure wedges can allow attachment to come off.

W-2715-0208

Figure 277

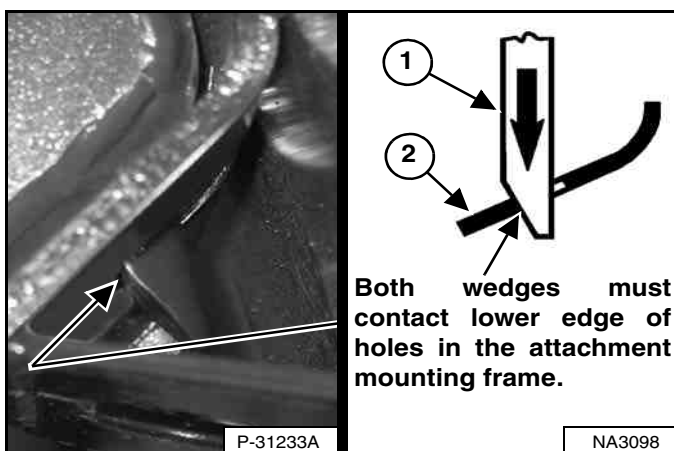

The wedges (Item 1) [Figure 277] must extend through the holes in the attachment mounting frame.

The spring loaded wedges (Item 1) must contact the lower edge of the holes in the attachment mounting frame (Item 2) [Figure 277].

If the wedges do not contact the lower edge of the holes [Figure 277], the attachment will be loose and can come off the Bob-Tach.

Figure 278

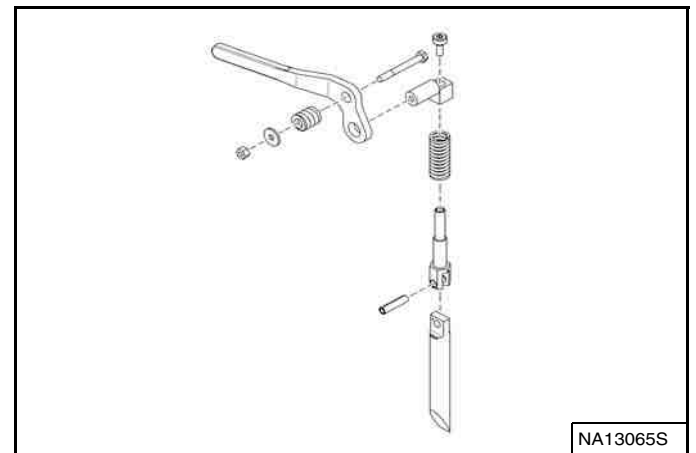

Inspect the mounting frame on the attachment and Bob-Tach, linkages, and wedges for excessive wear or damage [Figure 278]. Replace any parts that are damaged, bent, or missing. Keep all fasteners tight.

Look for cracked welds. Contact your Bobcat dealer for repair or replacement parts.

Lubricate the wedges. (See SERVICE SCHEDULE on Page 122.) and (See LUBRICATING THE LOADER on Page 177.)



LOADER STORAGE AND RETURN TO SERVICE

Storage

You may decide to store your Bobcat loader for an extended period of time. Perform the procedures below for storage:

- Thoroughly clean the loader including the engine compartment.
- Lubricate the loader.
- Replace worn or damaged parts.
- Park the loader in a dry protected shelter.
- Lower the lift arms all the way and put the bucket flat on the ground.
- Put blocks under the frame to remove weight from the tyres.
- Put grease on any exposed cylinder rods.
- Put fuel stabiliser in the fuel tank and operate the engine a few minutes to circulate the stabiliser to the pump and fuel injectors.

If biodiesel blend fuel has been used, perform the following:

Drain the fuel tank, refill with 100% petroleum diesel fuel, add fuel stabiliser, and operate the engine for at least 30 minutes.

- Drain and flush the cooling system. Refill with premixed coolant.
- Replace all fluids and filters (engine, hydraulic / hydrostatic).
- Replace air cleaner and heater filters.
- Put all controls in NEUTRAL position.
- Remove the battery. Be sure the electrolyte level is correct, then charge the battery. Store the battery in a cool dry location above freezing temperatures and charge the battery periodically during storage.
- Cover the exhaust pipe opening.
- Tag the machine to indicate that the machine is in storage condition.

Return To Service

After the Bobcat loader has been in storage, perform the procedures below to return the loader to service:

- Check the engine oil and hydraulic fluid levels; check coolant level.
- Install a fully charged battery.
- Remove grease from exposed cylinder rods.
- Check all belt tensions.
- Be sure all shields and guards are in position.
- Lubricate the loader.
- Check tyre inflation and remove blocks from under frame.
- Remove cover from exhaust pipe opening.
- Start the engine and operate for a few minutes while observing the instrument panels and systems for correct operation.
- Operate machine, check for correct function.
- Stop the engine and check for leaks. Repair as needed.



SYSTEM SETUP AND ANALYSIS

DIAGNOSTIC SERVICE CODES	184
Viewing Service Codes	184
Service Codes List	185
CONTROL PANEL SETUP	191
Right Panel Setup (Deluxe Instrumentation Panel)	191
PASSWORD SETUP (KEYLESS START PANEL)	195
Password Description	195
Changing The Owner Password	195
Password Lockout Feature	195
PASSWORD SETUP (DELUXE INSTRUMENTATION PANEL)	196
Password Description	196
Changing The Owner Password	196
Changing The User Passwords	197
Password Lockout Feature	197
MAINTENANCE CLOCK	198
Description	198
Setup	198
Reset	198

DIAGNOSTIC SERVICE CODES

Viewing Service Codes

The Service Codes will aid your dealer in diagnosing conditions that can damage your machine.

Left Panel

Figure 279



Press the Information button (Item 2) to cycle the data display (Item 1) [Figure 279] until the service code screen is displayed. If more than one service code is present, the codes will scroll on the data display.

When no service code is present, [NONE] is displayed [Figure 279].

NOTE: Corroded or loose earths can cause multiple service codes and / or abnormal symptoms. All instrument panel lights flashing, alarm sounding, headlights and taillights flashing, can indicate a bad earth. The same symptoms can apply if the voltage is low, such as loose or corroded battery cables. If you observe these symptoms, check earths and positive leads first.

Deluxe Instrumentation Panel

The optional Deluxe Instrumentation Panel offers an additional view of service codes that includes a brief description.

The last 40 codes stored in history can also be viewed using the Deluxe Instrumentation Panel.

	<p>Press a scroll button (Item 1) repeatedly until the Active Warnings screen icon (Inset) is highlighted.</p>
	<p>The ACTIVE WARNINGS screen displays active service codes. Press [9] to view the next service code if more than one is present. Press [4] to display a history of service codes.</p>
	<p>The WARNINGS HISTORY screen will list the Service Code Number (CODE), Hourmeter reading when the error occurred (HOUR), and the User (USER) who was logged in to operate the machine when the error occurred.</p>
<p>Press [9] to view the next eight service codes.</p>	
<p>A total of 40 codes can be stored. When more than 40 codes occur, the oldest code will disappear and the newest code will be in the number 1 position.</p>	
	<p>Press the list number next to the service code for more detail.</p> <p>Press the left scroll button to back up one screen.</p>



DIAGNOSTIC SERVICE CODES (CONT'D)

Service Codes List

Figure 280

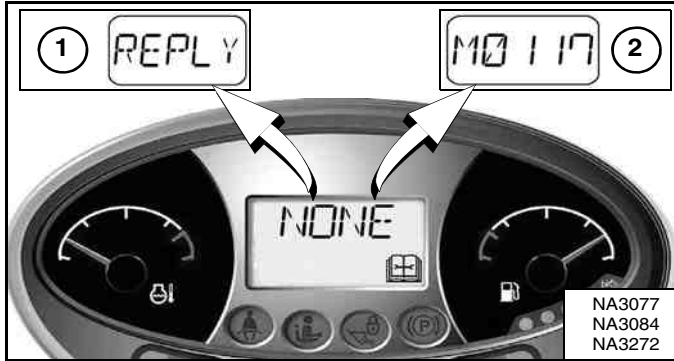

Service codes may be either a word (Item 1) or a number (Item 2) [Figure 280].

The following word errors may be displayed:

[REPLY] One or both instrument panel(s) not communicating with the controller.

[CODE] The controller is asking for a password. (Keyless Start and Deluxe Instrumentation Panels only.)

[ERROR] The wrong password was entered. (Keyless Start and Deluxe Instrumentation Panels only.)

[SHTDN] A shutdown condition exists.

[DOOR] Operator cab door is open. (Lift and Tilt functions will not operate.)

[RFOFF] Reversing fan is disabled. (See Reversing Fan on Page 83.)

CODE	DESCRIPTION	CODE	DESCRIPTION
A0618	Wheel speed out of range	A8307	ACD output 'D' open circuit
A3623	ACD not programmed	A8332	ACD output 'D' overcurrent
A4621	5 volt sensor supply out of range high	A8402	ACD output 'E' error ON
A4622	5 volt sensor supply out of range low	A8403	ACD output 'E' error OFF
A4721	8 volt sensor supply out of range high	A8405	ACD output 'E' short to battery
A4722	8 volt sensor supply out of range low	A8406	ACD output 'E' short to earth
A7701	Machine key active	A8407	ACD output 'E' open circuit
A7901	E-Stop active	A8432	ACD output 'E' overcurrent
A8002	ACD output 'A' error ON	A8502	ACD output 'F' error ON
A8003	ACD output 'A' error OFF	A8503	ACD output 'F' error OFF
A8005	ACD output 'A' short to battery	A8505	ACD output 'F' short to battery
A8006	ACD output 'A' short to earth	A8506	ACD output 'F' short to earth
A8007	ACD output 'A' open circuit	A8507	ACD output 'F' open circuit
A8032	ACD output 'A' overcurrent	A8532	ACD output 'F' overcurrent
A8102	ACD output 'B' error ON	A8602	ACD output 'G' error ON
A8103	ACD output 'B' error OFF	A8603	ACD output 'G' error OFF
A8105	ACD output 'B' short to battery	A8605	ACD output 'G' short to battery
A8106	ACD output 'B' short to earth	A8606	ACD output 'G' short to earth
A8107	ACD output 'B' open circuit	A8607	ACD output 'G' open circuit
A8132	ACD output 'B' overcurrent	A8702	ACD output 'H' error ON
A8202	ACD output 'C' error ON	A8703	ACD output 'H' error OFF
A8203	ACD output 'C' error OFF	A8705	ACD output 'H' short to battery
A8205	ACD output 'C' short to battery	A8706	ACD output 'H' short to earth
A8206	ACD output 'C' short to earth	A8707	ACD output 'H' open circuit
A8207	ACD output 'C' open circuit	A8802	Reverse solenoid error ON
A8232	ACD output 'C' overcurrent	A8803	Reverse solenoid error OFF
A8302	ACD output 'D' error ON		
A8303	ACD output 'D' error OFF	D3905	Left joystick X-axis not in NEUTRAL
A8305	ACD output 'D' short to battery	D3907	Left joystick Y-axis not in NEUTRAL
A8306	ACD output 'D' short to earth	D4007	Right joystick Y-axis not in NEUTRAL



DIAGNOSTIC SERVICE CODES (CONT'D)

Service Codes List (Cont'd)

CODE	DESCRIPTION	CODE	DESCRIPTION
D7501	Drive CAN joystick information error	D7546	Drive right reverse drive solenoid error ON
D7504	Drive no communication from drive controller	D7547	Drive right front steer extend short to battery
D7505	Drive left joystick X-axis not in NEUTRAL	D7548	Drive left front steer extend short to battery
D7507	Drive left joystick Y-axis not in NEUTRAL	D7549	Drive right rear steer extend short to battery
D7508	Drive right joystick Y-axis not in NEUTRAL	D7550	Drive left rear steer extend short to battery
D7509	Drive operating mode switch short to earth or battery	D7551	Drive steer pressure short to battery
D7510	Drive improper joysticks installed	D7552	Drive back-up alarm error ON
D7511	Drive left speed sensor not connected	D7553	Drive left forward drive solenoid error OFF
D7512	Drive right speed sensor not connected	D7554	Drive left reverse drive solenoid error OFF
D7513	Drive right front wheel angle sensor stuck	D7555	Drive right forward drive solenoid error OFF
D7514	Drive left front wheel angle sensor stuck	D7556	Drive right reverse drive solenoid error OFF
D7515	Drive right rear wheel angle sensor stuck	D7557	Drive right front steer extend short to earth
D7516	Drive left rear wheel angle sensor stuck	D7558	Drive right front steer retract short to earth
D7517	Drive left swash plate not in NEUTRAL	D7559	Drive left front steer extend short to earth
D7518	Drive right swash plate not in NEUTRAL	D7560	Drive left front steer retract short to earth
D7519	Drive left joystick X-axis out of range high	D7561	Drive right rear steer extend short to earth
D7521	Drive left joystick Y-axis out of range high	D7562	Drive right rear steer retract short to earth
D7522	Drive right joystick Y-axis out of range high	D7563	Drive left rear steer extend short to earth
D7523	Drive right front wheel angle sensor out of range high	D7564	Drive left rear steer retract short to earth
D7524	Drive left front wheel angle sensor out of range high	D7565	Drive steer pressure short to earth
D7525	Drive right rear wheel angle sensor out of range high	D7566	Drive back-up alarm error OFF
D7526	Drive left rear wheel angle sensor out of range high	D7567	Drive no communication from Bobcat controller
D7527	Drive left swash plate out of position	D7568	Drive angle sensors not calibrated
D7528	Drive right swash plate out of position	D7569	Drive battery voltage out of range high
D7529	Drive left joystick X-axis out of range low	D7570	Drive interrupted power (also occurs after software updates)
D7531	Drive left joystick Y-axis out of range low	D7571	Drive battery voltage out of range low
D7532	Drive right joystick Y-axis out of range low	D7572	Drive pump not calibrated
D7533	Drive right front wheel angle sensor out of range low	D7573	Drive operating mode switch flipped while operating
D7534	Drive left front wheel angle sensor out of range low	D7574	Drive right wheel speed uncommanded motion
D7535	Drive right rear wheel angle sensor out of range low	D7575	Drive left wheel speed uncommanded motion
D7536	Drive left rear wheel angle sensor out of range low	D7576	Drive no communication from ACS controller
D7537	Drive 5 volt sensor supply 1 out of range low	D7577	Drive left speed sensor out of range high
D7538	Drive 5 volt sensor supply 2 out of range low	D7578	Drive right speed sensor out of range high
D7539	Drive left swash plate sensor out of range high	D7579	Drive left speed sensor out of range low
D7540	Drive left swash plate sensor out of range low	D7580	Drive right speed sensor out of range low
D7541	Drive right swash plate sensor out of range high	D7581	Drive right front steer retract short to battery
D7542	Drive right swash plate sensor out of range low	D7582	Drive left front steer retract short to battery
D7543	Drive left forward drive solenoid error ON	D7583	Drive right rear steer retract short to battery
D7544	Drive left reverse drive solenoid error ON	D7584	Drive left rear steer retract short to battery
D7545	Drive right forward drive solenoid error ON	D7585	Drive 5 volt sensor supply 1 out of range high



DIAGNOSTIC SERVICE CODES (CONT'D)

Service Codes List (Cont'd)

CODE	DESCRIPTION	CODE	DESCRIPTION
D7586	Drive 5 volt sensor supply 2 out of range high	H2307	Rear base output open circuit
D7587	Drive software update required	H2332	Rear base output overcurrent
D7588	Drive switched power stuck ON	H2405	Rear rod output short to battery
D7589	Drive switched power error OFF	H2406	Rear rod output short to earth
D7590	Drive calibration performed	H2407	Rear rod output open circuit
D7591	Drive left swash plate sensor reversed	H2432	Rear rod output overcurrent
D7592	Drive right swash plate sensor reversed	H2505	Diverter #2 short to battery
D7593	Drive unresponsive right speed sensor	H2506	Diverter #2 short to earth
D7594	Drive unresponsive left speed sensor	H2507	Diverter #2 open circuit
D7595	Drive left speed sensor reverse direction	H2605	Front base output short to battery
D7596	Drive right speed sensor reverse direction	H2606	Front base output short to earth
D7597	Drive controller programmed	H2607	Front base output open circuit
D7598	Drive controller in calibration mode	H2632	Front base output overcurrent
D7599	Drive AWS controller in wheel position calibration mode	H2705	Front rod output short to battery
		H2706	Front rod output short to earth
H1221	Right thumb switch out of range high	H2707	Front rod output open circuit
H1222	Right thumb switch out of range low	H2732	Front rod output overcurrent
H1224	Right thumb switch not in NEUTRAL	H2805	Diverter short to battery
H1321	Left thumb switch out of range high	H2806	Diverter short to earth
H1322	Left thumb switch out of range low	H2807	Diverter open circuit
H1324	Left thumb switch not in NEUTRAL	H2905	High-flow short to battery
H1421	Lift base pressure out of range high	H2906	High-flow short to earth
H1422	Lift base pressure out of range low	H2907	High-flow open circuit
H1502	Ride control output error ON	H2932	High-flow overcurrent
H1503	Ride control output error OFF	H3028	Controller memory failure
H1507	Ride control output open circuit	H3128	Interrupted power failure
H1528	Ride control output failure	H3648	Multiple ACD conflict error
H1602	Ride control relay error ON	H3904	Left joystick in error
H1603	Ride control relay error OFF	H3912	Left joystick thumb switch not in NEUTRAL
H2005	Boost solenoid short to battery	H3913	Left joystick grip no communication
H2006	Boost solenoid short to earth	H3916	Left joystick no communication
H2007	Boost solenoid open circuit	H3928	Left joystick internal failure
H2032	Boost solenoid overcurrent	H3948	Left joystick multiple
H2105	Reverse fan solenoid short to battery	H4004	Right joystick in error
H2106	Reverse fan solenoid short to earth	H4012	Right joystick thumb switch not in NEUTRAL
H2107	Reverse fan solenoid open circuit	H4013	Right joystick grip no communication
H2132	Reverse fan solenoid overcurrent	H4016	Right joystick no communication
H2005	Boost solenoid short to battery	H4028	Right joystick internal failure
H2006	Boost solenoid short to earth	H4048	Right joystick multiple
H2007	Boost solenoid open circuit	H4302	Horn error ON
H2032	Boost solenoid overcurrent	H4303	Horn error OFF
H2305	Rear base output short to battery	H4423	Auxiliary not programmed
H2306	Rear base output short to earth	H4497	Auxiliary controller programmed



DIAGNOSTIC SERVICE CODES (CONT'D)

Service Codes List (Cont'd)

CODE	DESCRIPTION	CODE	DESCRIPTION
H4502	Right blinker error ON	M0710	Hydraulic fluid temperature too high
H4503	Right blinker error OFF	M0711	Hydraulic fluid temperature extremely high
H4602	Left blinker error ON	M0715	Hydraulic fluid temperature in shutdown
H4603	Left blinker error OFF	M0721	Hydraulic fluid temperature out of range high
H4721	8 volt sensor supply out of range high	M0722	Hydraulic fluid temperature out of range low
H4722	8 volt sensor supply out of range low	M0810	Engine coolant temperature too high
H4821	5 volt sensor supply out of range high	M0811	Engine coolant temperature extremely high
H4822	5 volt sensor supply out of range low	M0815	Engine coolant temperature in shutdown
H7404	Main controller no communication	M0821	Engine coolant temperature out of range high
H9004	Press to operate loader keypad no communication	M0822	Engine coolant temperature out of range low
		M0909	Fuel level too low
L0102	Lights button error ON	M0921	Fuel level out of range high
L0202	High-flow enable / auto idle enable button error ON	M0922	Fuel level out of range low
L0302	Auxiliary enable button error ON	M1016	Hydraulic charge filter not connected
L0402	Information button error ON	M1017	Hydraulic charge filter plugged
L7404	Main controller no communication	M1121	Seat bar sensor out of range high
L7672	Left display panel needs programming	M1122	Seat bar sensor out of range low
		M1128	Seat bar sensor failure
M0116	Air filter not connected	M1305	Fuel hold solenoid short to battery
M0117	Air filter plugged	M1306	Fuel hold solenoid short to earth
M0216	Hydraulic / Hydrostatic filter not connected	M1307	Fuel hold solenoid open circuit
M0217	Hydraulic / Hydrostatic filter plugged	M1402	Fuel pull solenoid error ON
M0309	System voltage too low	M1403	Fuel pull solenoid error OFF
M0310	System voltage too high	M1407	Fuel pull solenoid open circuit
M0311	System voltage extremely high	M1428	Fuel pull solenoid failure
M0314	System voltage extremely low	M1502	Traction lock pull output error ON
M0322	System voltage out of range low	M1503	Traction lock pull output error OFF
M0409	Engine oil pressure too low	M1507	Traction lock pull output open circuit
M0414	Engine oil pressure extremely low	M1528	Traction lock pull output failure
M0415	Engine oil pressure in shutdown	M1605	Traction lock hold solenoid short to battery
M0421	Engine oil pressure out of range high	M1606	Traction lock hold solenoid short to earth
M0422	Engine oil pressure out of range low	M1607	Traction lock hold solenoid open circuit
M0509	Hydraulic charge pressure too low	M1705	Hydraulic lock valve short to battery
M0510	Hydraulic charge pressure too high	M1706	Hydraulic lock valve short to earth
M0511	Hydraulic charge pressure extremely high	M1707	Hydraulic lock valve open circuit
M0514	Hydraulic charge pressure extremely low	M1732	Hydraulic lock valve overcurrent
M0515	Hydraulic charge pressure in shutdown	M1805	Lift spool lock output short to battery
M0521	Hydraulic charge pressure out of range high	M1806	Lift spool lock output short to earth
M0522	Hydraulic charge pressure out of range low	M1807	Lift spool lock output open circuit
M0610	Engine speed too high	M1832	Lift spool lock output overcurrent
M0611	Engine speed extremely high	M2005	Two-speed primary solenoid short to battery
M0613	Engine speed no signal	M2006	Two-speed primary solenoid short to earth
M0615	Engine speed in shutdown	M2007	Two-speed primary solenoid open circuit
M0618	Engine speed out of range	M2032	Two-speed primary solenoid overcurrent
M0634	Engine speed invalid information from ECU	M2102	Glow plug output error ON



DIAGNOSTIC SERVICE CODES (CONT'D)

Service Codes List (Cont'd)

CODE	DESCRIPTION	CODE	DESCRIPTION
M2103	Glow plug output error OFF	M4621	5 volt sensor supply out of range high
M2107	Glow plug output open circuit	M4622	5 volt sensor supply out of range low
M2128	Glow plug output failure	M4721	8 volt sensor supply out of range high
M2202	Starter output error ON	M4722	8 volt sensor supply out of range low
M2203	Starter output error OFF	M4802	Front light relay error ON
M2207	Starter output open circuit	M4803	Front light relay error OFF
M2228	Starter output failure	M4902	Rear light relay error ON
M2302	Starter relay error ON	M4903	Rear light relay error OFF
M2303	Starter relay error OFF	M5002	Front light output error ON
M2402	Fuel pull relay error ON	M5003	Front light output error OFF
M2403	Fuel pull relay error OFF	M5007	Front light output open circuit
M2502	Traction pull relay error ON	M5028	Front light output failure
M2503	Traction pull relay error OFF	M5102	Rear light output error ON
M2602	Glow plug relay error ON	M5103	Rear light output error OFF
M2603	Glow plug relay error OFF	M5107	Rear light output open circuit
M2721	Throttle primary sensor out of range high	M5128	Rear light output failure
M2722	Throttle primary sensor out of range low	M5202	Press to operate button error ON
M2821	Throttle secondary sensor out of range high	M5221	Press to operate button out of range high
M2822	Throttle secondary sensor out of range low	M5222	Press to operate button out of range low
M2899	Throttle secondary sensor not calibrated	M5305	Press to operate light short to battery
M3028	Controller memory failure	M5306	Press to operate light short to earth
M3128	Interrupted power failure	M5405	Tilt spool lock short to battery
M3204	ACS (AHC) no communication to Bobcat controller	M5406	Tilt spool lock short to earth
M3304	Deluxe panel no communication	M5407	Tilt spool lock open circuit
M3404	Deluxe panel in error	M5432	Tilt spool lock overcurrent
M3505	Hydraulic fan short to battery	M5902	DPF regeneration switch error ON
M3506	Hydraulic fan short to earth	M6002	DPF inhibit regeneration switch error ON
M3507	Hydraulic fan open circuit	M6102	Remote parked regeneration switch error ON
M3532	Hydraulic fan overcurrent	M6402	Switched power relay error ON
M3705	Two-speed second output short to battery	M6403	Switched power relay error OFF
M3706	Two-speed second output short to earth	M6505	ECU power short to battery
M3707	Two-speed second output open circuit	M6506	ECU power short to earth
M3732	Two-speed second output overcurrent	M6507	ECU power open circuit
M3805	Auxiliary hydraulic lock short to battery	M6604	ECU no communication
M3806	Auxiliary hydraulic lock short to earth	M6702	HVAC output error ON
M3807	Auxiliary hydraulic lock open circuit	M6703	HVAC output error OFF
M3832	Auxiliary hydraulic lock overcurrent	M6707	HVAC output open circuit
M4109	Alternator too low	M6728	HVAC output failure
M4110	Alternator high	M6802	HVAC relay error ON
M4111	Alternator extremely high	M6803	HVAC relay error OFF
M4304	Keyless panel no communication	M7002	Switched power output error ON
M4404	Auxiliary no communication	M7003	Switched power output error OFF
M4510	Water in fuel sensor too high	M7007	Switched power output open circuit
M4511	Water in fuel sensor extremely high	M7028	Switched power output failure
M4521	Water in fuel sensor out of range high	M7304	Remote control no communication
M4522	Water in fuel sensor out of range low	M7316	Remote control no communication to transmitter



DIAGNOSTIC SERVICE CODES (CONT'D)

Service Codes List (Cont'd)

CODE	DESCRIPTION	CODE	DESCRIPTION
M7423	Main controller not programmed	W3233	ACS (AHC) tilt handle wiring
M7472	Main controller needs programming	W3234	ACS (AHC) tilt actuator not in NEUTRAL
M7497	Main controller programmed	W3235	ACS (AHC) tilt handle / pedal not in NEUTRAL
M7504	Drive no communication	W3236	ACS (AHC) lift actuator
M7604	Left display panel no communication	W3237	ACS (AHC) lift actuator wiring
M7748	Key switch multiple	W3238	ACS (AHC) lift handle wiring
M7839	Hourmeter changed	W3239	ACS (AHC) lift actuator not in NEUTRAL
M7974	Door open	W3240	ACS (AHC) lift handle / pedal not in NEUTRAL
M8541	DPF automatic regeneration active	W3241	ACS (AHC) no communication
M8542	DPF automatic regeneration active (Operate machine under load)	W3249	ACS (AHC) lift actuator short to earth
M8551	DPF regeneration needed - inhibit active	W3250	ACS (AHC) tilt actuator short to earth
M8552	DPF regeneration needed - inhibit active (Operate machine under load)	W3251	ACS (AHC) lift actuator short to battery
M8553	DPF remote parked regeneration required (Remote regeneration kit required)	W3252	ACS (AHC) tilt actuator short to battery
M8554	DPF service regeneration required (Contact Bobcat dealer)	W3253	ACS (AHC) lift handle / pedal short to earth
M8555	DPF service required	W3254	ACS (AHC) tilt handle / pedal short to earth
M8560	DPF service regeneration active	W3255	ACS (AHC) lift handle / pedal short to battery
M8561	DPF service regeneration active	W3256	ACS (AHC) tilt handle / pedal short to battery
M8562	DPF service regeneration active	W3257	ACS (AHC) lift actuator reduced performance
M8563	DPF service regeneration active	W3258	ACS (AHC) tilt actuator reduced performance
M8564	DPF service regeneration active	W3259	ACS (AHC) lift actuator wrong direction
M8615	Engine speed derate in shutdown	W3260	ACS (AHC) tilt actuator wrong direction
M8625	Engine speed derate unresponsive	W3261	ACS (AHC) handle lock short to earth
M9004	Press to operate loader keypad no communication	W3262	ACS (AHC) handle lock short to battery
R7404	Main controller no communication	W3263	ACS (AHC) pedal lock short to earth
		W3264	ACS (AHC) pedal lock short to battery
T9002	Service tool output 'C' error ON	W3265	ACS (AHC) sensor supply voltage out of range
T9003	Service tool output 'C' error OFF	W3266	ACS (AHC) battery voltage out of range
T9102	Service tool output 'D' error ON	W3267	ACS (AHC) switch flipped while operating
T9103	Service tool output 'D' error OFF	W3268	ACS (AHC) lift handle information error
T9202	Service tool output 'E' error ON	W3270	ACS (AHC) right drive handle short to earth
T9203	Service tool output 'E' error OFF	W3271	ACS (AHC) right drive handle short to battery
T9302	Service tool output 'F' error ON	W3274	ACS (AHC) left joystick X-axis out of range
T9303	Service tool output 'F' error OFF	W3275	ACS (AHC) interrupted unswitched power
		W3276	ACS (AHC) CAN joystick information error
W3204	ACS (AHC) no communication to Bobcat controller	W3277	ACS (AHC) remote control information error
W3223	ACS (AHC) calibration required	W3297	ACS (AHC) controller programmed
W3224	ACS (AHC) calibration performed	W3905	Left joystick X-axis not in NEUTRAL
W3225	ACS (AHC) actuator calibration failed	W4005	Right joystick X-axis not in NEUTRAL
W3231	ACS (AHC) tilt actuator	W4007	Right joystick Y-axis not in NEUTRAL
W3232	ACS (AHC) tilt actuator wiring		



CONTROL PANEL SETUP

Right Panel Setup (Deluxe Instrumentation Panel)

Icon Identification

Figure 281



ICON	DESCRIPTION
Mon, 17 Mar 3:45 PM	DATE / TIME
BRADY 232.5 hrs	USER / HOURMETER
Current Job 456.7 hrs	CURRENT JOB HOURS
	ACTIVE WARNINGS screen icon
	VITALS screen icon
	SERVICE screen icon
	MAIN screen icon
	ATTACHMENTS screen icon
	SECURITY screen icon
	DISPLAY screen icon
	HOME icon (Return to MAIN screen)
	LEFT SCROLL button
	RIGHT SCROLL button
	ENTER button

Vitals

	<p>Press a scroll button (Item 1) repeatedly until the Vitals screen icon (Inset) is highlighted.</p>
	<p>Displays select system operating levels.</p>
<p>You can monitor real-time displays of:</p> <ul style="list-style-type: none"> Engine Speed Engine Oil Pressure Engine Coolant Temperature System Voltage Hydraulic Charge Pressure Hydraulic Fluid Temperature 	

The Deluxe Instrumentation Panel is easy to use. Continue to set your own preferences for operating / monitoring your Bobcat loader.



CONTROL PANEL SETUP (CONT'D)

Right Panel Setup (Deluxe Instrumentation Panel) (Cont'd)

Date And Time

	<p>Press a scroll button (Item 1) repeatedly until the Display screen icon (Inset) is highlighted.</p>
	<p>Select [1. CLOCKS].</p>
	<p>Select [1. TIME].</p>
	<p>Use the keypad to enter time. Select AM / PM / 24hr. Press [ENTER] to continue.</p>
	<p>Select [2. DATE].</p>
	<p>Use the keypad to enter date. Press [ENTER] to continue.</p>

Languages

	<p>Press a scroll button (Item 1) repeatedly until the Display screen icon (Inset) is highlighted.</p>
	<p>Select [2. LANGUAGES].</p>
	<p>Select the desired language.</p>

English / Metric Display

	<p>Press a scroll button (Item 1) repeatedly until the Display screen icon (Inset) is highlighted.</p>
	<p>Select [4. DISPLAY SETTINGS].</p>
	<p>Press [1] to cycle between ENGLISH and METRIC.</p>



CONTROL PANEL SETUP (CONT'D)

Right Panel Setup (Deluxe Instrumentation Panel) (Cont'd)

Job Clock Reset

	<p>Press a scroll button (Item 1) repeatedly until the Security screen icon (Inset) is highlighted.</p>
	<p>Select [1. PASSWORDS / LOCKOUTS].</p>
	<p>Enter owner password and press [ENTER].</p>
	<p>Select [1. USER SETTINGS].</p>
	<p>Select user.</p>
	<p>Select [3. RESET JOB STATISTICS].</p>
	<p>Press [9] to reset job statistics. Press left scroll button or [0] to exit without saving.</p>



CONTROL PANEL SETUP (CONT'D)

Right Panel Setup (Deluxe Instrumentation Panel) (Cont'd)

Machine Lockouts (High Flow And Two-Speed)

	<p>Press a scroll button (Item 1) repeatedly until the Security screen icon (Inset) is highlighted.</p>
	<p>Select [1. PASSWORDS / LOCKOUTS].</p>
	<p>Enter owner password and press [ENTER].</p>
	<p>Select [3. HIGH FLOW]. OR Select [4. TWO-SPEED].</p>
	<p>HIGH FLOW Press user number to cycle between LOCKED and UNLOCKED.</p>
	<p>TWO-SPEED Press user number to cycle between LOCKED and UNLOCKED.</p>

NOTE: High-Flow and Two-Speed lockouts for the owner are active even if the Password Lockout feature is unlocked.

Machine Lockouts (Travel Speed) (SJC Only)

	<p>Press a scroll button (Item 1) repeatedly until the Security screen icon (Inset) is highlighted.</p>																														
	<p>Select [1. PASSWORDS / LOCKOUTS].</p>																														
	<p>Enter owner password and press [ENTER].</p>																														
	<p>Select [5. TRAVEL SPEED].</p>																														
<table border="1" data-bbox="817 1364 1161 1603"> <thead> <tr> <th>USER</th> <th>MAX F</th> <th>MAX R</th> </tr> </thead> <tbody> <tr> <td>1. SPENCER</td> <td>100%</td> <td>100%</td> </tr> <tr> <td>2. TONY</td> <td>75%</td> <td>100%</td> </tr> <tr> <td>3. BRADY</td> <td>25%</td> <td>25%</td> </tr> <tr> <td>4. SAMT</td> <td>25%</td> <td>100%</td> </tr> <tr> <td>5. ALAN</td> <td>100%</td> <td>100%</td> </tr> <tr> <td>6. DEAN</td> <td>100%</td> <td>100%</td> </tr> <tr> <td>7. MICHAEL</td> <td>75%</td> <td>75%</td> </tr> <tr> <td>8. JOHN</td> <td>75%</td> <td>75%</td> </tr> <tr> <td>9. SMYTH</td> <td>75%</td> <td>75%</td> </tr> </tbody> </table>	USER	MAX F	MAX R	1. SPENCER	100%	100%	2. TONY	75%	100%	3. BRADY	25%	25%	4. SAMT	25%	100%	5. ALAN	100%	100%	6. DEAN	100%	100%	7. MICHAEL	75%	75%	8. JOHN	75%	75%	9. SMYTH	75%	75%	<p>TRAVEL SPEED Select user.</p>
USER	MAX F	MAX R																													
1. SPENCER	100%	100%																													
2. TONY	75%	100%																													
3. BRADY	25%	25%																													
4. SAMT	25%	100%																													
5. ALAN	100%	100%																													
6. DEAN	100%	100%																													
7. MICHAEL	75%	75%																													
8. JOHN	75%	75%																													
9. SMYTH	75%	75%																													
	<p>FORWARD / REVERSE TRAVEL SPEED LIMIT Enter forward travel speed limit as a percentage and press [ENTER] to save. Enter reverse travel speed limit as a percentage and press [ENTER] to save.</p>																														

PASSWORD SETUP (KEYLESS START PANEL)

Password Description

Master Password:

A permanent, randomly selected password set at the factory that cannot be changed. This password is used for service by the Bobcat dealer if the owner password is not known or to change the owner password.

Owner Password:

Allows for full use of the loader. Must be used to change the owner password.

Changing The Owner Password

Turn the key switch to the RUN position to turn on the loaders electrical system.

Enter the five digit owner password using the number keys (1 through 0) if locked.

Figure 282



Press and hold the lock (Item 1) and unlock (Item 2) [Figure 282] keys for 2 seconds.

The lock key red light will flash and the left panel display screen will show [ENTER].

Enter a new five digit owner password using the number keys (1 through 0). An asterisk will show in the left panel display screen for each key press.

The left panel display screen will show [AGAIN].

Enter the new five digit owner password again.

The lock key red light will become solid.

Password Lockout Feature

This feature allows the owner to unlock the password feature so that a password does not need to be used every time the engine is started.

Turn the key switch to the RUN position to turn on the loaders electrical system.

Enter the five digit owner password using the number keys (1 through 0).

Press the unlock key (Item 2) [Figure 282].

The left panel display screen will show [CODE].

Enter the five digit owner password using the number keys (1 through 0). The unlock key green light will flash, then become solid.

The loader can now be started without using a password.

NOTE: Use the following procedure to reset the machine lock so that the loader requires a password to start the engine.

Turn the key switch to the RUN position to turn on the loaders electrical system.

Press the lock key (Item 1) [Figure 282].

The lock key red light will flash and the left panel display screen will show [CODE].

Enter the five digit owner password using the number keys (1 through 0). The unlock key green light will flash, then the lock key red light will become solid.

You must now enter the password every time to start the loader.



PASSWORD SETUP (DELUXE INSTRUMENTATION PANEL)

Password Description

All new machines with a Deluxe Instrumentation Panel arrive at Bobcat dealerships with the keypad in locked mode. Locked mode means that a password must be used to start the engine.

For security purposes, your dealer may change the password and set the keypad in the locked mode. Your dealer will provide you with the password.

Master Password:

A permanent, randomly selected password set at the factory that cannot be changed. This password is used for service by the Bobcat dealer if the owner password is not known or to change the owner password.

Owner Password:

Allows for full use of the loader and to set up the Deluxe Instrumentation Panel. There is only one owner password. The owner password must be used to change the owner or user passwords. Owner should change the password as soon as possible for security of the loader.

User Password:

Allows starting and operating the loader; cannot change passwords or lockout features.

For the procedures to change passwords: (See Changing The Owner Password on Page 196.) and (See Changing The User Passwords on Page 197.)

Changing The Owner Password

	<p>Press a scroll button (Item 1) repeatedly until the Security screen icon (Inset) is highlighted.</p>
	<p>Select [1. PASSWORDS / LOCKOUTS].</p>
	<p>Enter owner password and press [ENTER].</p>
	<p>Select [1. USER SETTINGS].</p>
	<p>Select [1. OWNER].</p>
	<p>Select [2. CHANGE PASSWORD].</p>
	<p>Enter new owner password and press [ENTER]. You will be prompted to reenter the new owner password.</p>



PASSWORD SETUP (DELUXE INSTRUMENTATION PANEL) (CONT'D)

Changing The User Passwords

	<p>Press a scroll button (Item 1) repeatedly until the Security screen icon (Inset) is highlighted.</p>
	<p>Select [1. PASSWORDS / LOCKOUTS].</p>
	<p>Enter owner password and press [ENTER].</p>
	<p>Select [1. USER SETTINGS].</p>
	<p>Select user.</p>
	<p>Select [2. CHANGE PASSWORD].</p>
	<p>Enter new user password and press [ENTER].</p>

Password Lockout Feature

This feature allows the owner to unlock the password feature so that a password does not need to be used every time the engine is started.

	<p>Press a scroll button (Item 1) repeatedly until the Security screen icon (Inset) is highlighted.</p>
	<p>Select [1. PASSWORDS / LOCKOUTS].</p>
	<p>Enter owner password and press [ENTER].</p>
	<p>Select [2. MACHINE LOCK].</p>

NOTE: The procedure above can be followed to reset the machine lock so that the machine requires a password to start the engine.

MAINTENANCE CLOCK

Description

The Maintenance Clock alerts the operator when the next service interval is due. *EXAMPLE:* The maintenance clock can be set to a 500 hour interval as a reminder for the next 500 hour planned maintenance.

Figure 283

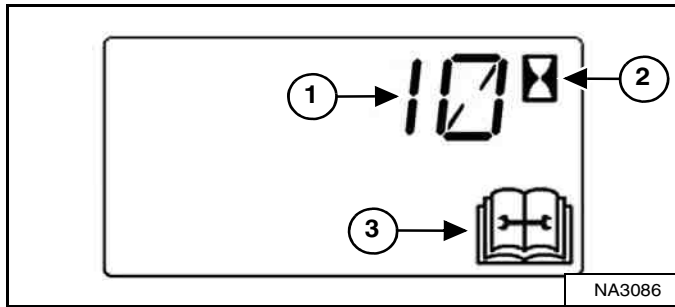

During machine operation, a 2 beep alarm will sound when there are less than 10 hours until the next planned maintenance.

The remaining hours before maintenance is required (Item 1) will appear in the data display for 5 seconds while the service icon (Item 3) and the hourmeter icon (Item 2) [Figure 283] flash.

NOTE: The display will show negative numbers after counting down to zero.

The display will revert to the previous display and will appear for 5 seconds every time the machine is started until the maintenance clock is reset.

Figure 284



The Deluxe Instrumentation Panel (if equipped) will display a message (Item 1) [Figure 284] alerting the operator to service the machine.

This message will appear for 10 seconds every time the machine is started until the maintenance clock is reset.

Figure 285



The Deluxe Instrumentation Panel (if equipped) will display a bar (Item 1) [Figure 285] showing the time remaining until next service. This bar will turn red when service is past due. [NEXT MAINTENANCE DUE] will change to [MAINTENANCE PAST DUE] and display the number of hours past due.

Keys [4] and [9] can be used to adjust the service interval when the owner is logged in [Figure 285].

Setup

See your Bobcat dealer about installation of this feature.

Reset

See your Bobcat dealer to reset the maintenance clock.



SPECIFICATIONS

(S510) LOADER SPECIFICATIONS	200
Machine Dimensions	200
Performance	201
Engine	201
Drive System	202
Controls	202
Hydraulic System	203
Electrical System	204
Capacities	204
Tyres	205
Environmental	205
Temperature Range	205

Certain specification(s) are based on engineering calculations and are not actual measurements. Specification(s) are provided for comparison purposes only and are subject to change without notice. Specification(s) for your individual Bobcat equipment will vary based on normal variations in design, manufacturing, operating conditions, and other factors.



(S510) LOADER SPECIFICATIONS

Machine Dimensions

- Dimensions are given for loader equipped with standard tyres and 68 in. Construction and Industrial bucket and may vary with other bucket types.
- Where applicable, specifications conform to SAE or ISO standards and are subject to change without notice.

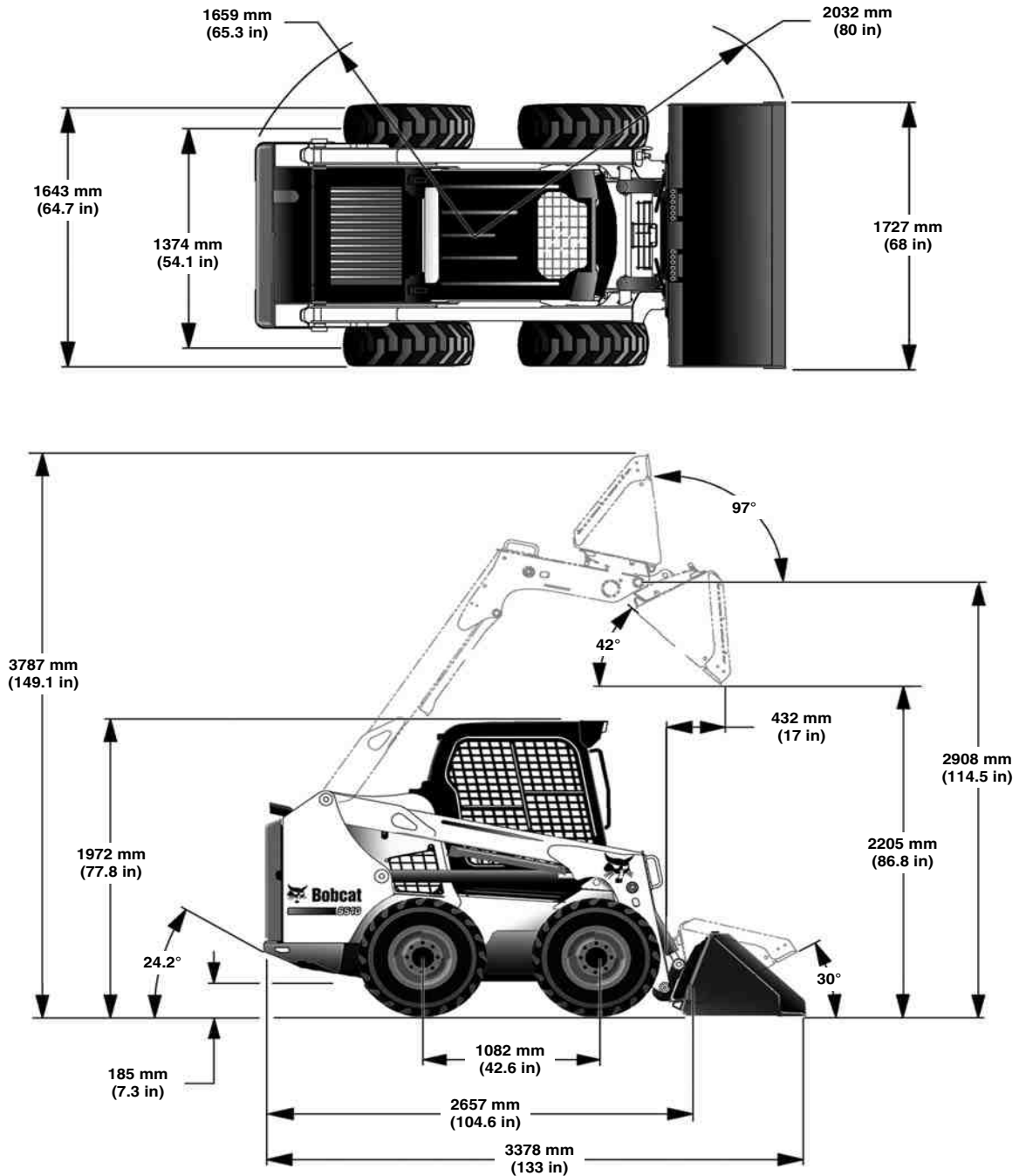

NA9078

Changes of structure or weight distribution of the loader can cause changes in control and steering response, and can cause failure of the loader parts.



(S510) LOADER SPECIFICATIONS (CONT'D)

Performance

Rated Operating Capacity (ISO 14397-1)	810 kg (1785 lb)
with 200 Pound Frame Mounted Counterweight Kit (ISO 14397-1)	878 kg (1935 lb)
Tipping Load (ISO 14397-1)	1619 kg (3570 lb)
Operating Weight	2686 kg (5922 lb)
Breakout Force - Lift	1470 kg (3242 lb)
Breakout Force - Tilt	1485 kg (3276 lb)
Push Force	2406 kg (5306 lb)
Travel Speed:	
- Single Speed Loader	0 - 11,8 km/h (0 - 7.35 mph)
- Two-Speed Loader (Option):	
Low Range	0 - 11,8 km/h (0 - 7.35 mph)
High Range	0 - 17,3 km/h (0 - 11.02 mph)

Engine

Make / Model	Kubota® / V2203-M-DI-E2B Stage III A
Fuel / Cooling	Diesel / Liquid
Horsepower:	
- ISO 9249 EEC / SAE J1349 Net	34,3 kW (46.0 hp) @ 2800 rpm
- ISO 14396 Gross	35,9 kW (48.1 hp) @ 2800 rpm
- SAE J1995 Gross	36,4 kW (48.8 hp) @ 2800 rpm
Torque:	
- ISO 9249 EEC / SAE J1349 Net	140,3 N•m (103.5 ft-lb) @ 1700 rpm
- SAE J1995 Gross	149,8 N•m (110.5 ft-lb) @ 1700 rpm
Low Idle rpm	1075 - 1225
High Idle rpm	2860 - 3000
Number of Cylinders	4
Displacement	2196 cm ³ (134 in ³)
Bore / Stroke	87 mm / 92 mm (3.43 in / 3.64 in)
Lubrication	Gear Pump Pressure System with Filter
Crankcase Ventilation	Closed Breathing
Air Cleaner	Dry replaceable paper cartridge with separate safety element
Ignition	Diesel - Compression
Air Induction	Naturally Aspirated
Engine Coolant	Propylene Glycol / Water Mixture
Starting Aid	Glow plugs automatically activated as needed in RUN position



(S510) LOADER SPECIFICATIONS (CONT'D)

Drive System

Main Drive	Fully hydrostatic, 4-wheel drive
Transmission	Infinitely variable tandem hydrostatic piston pumps, driving two fully reversing hydrostatic motors
Final Drive	Prestressed #80 HSOC endless roller chain (no master link) and sprockets in sealed chaincase with oil lubrication (Chains do not require periodic adjustments) Two chains per side with no idler sprocket
Axle Size	50,29 mm (1.98 in), heat treated
Wheel Bolts	Eight - 9/16 in. wheel bolts fixed to axle hubs

Controls

Machine Steering	Direction and speed controlled by two hand operated steering levers or optional joystick(s)
Loader Hydraulics: - Lift and Tilt - Front Auxiliary - Rear Auxiliary (Option)	Controlled by separate foot pedals or optional Advanced Control System (ACS) or optional Advanced Hand Controls (AHC) or optional Selectable Joystick Controls (SJC) Controlled by electrical switch on Right Hand steering lever or joystick Controlled by electrical switch on Left Hand steering lever or joystick
Auxiliary Pressure Release	Pressure relieved through quick couplers; Push couplers in, hold for 5 seconds
Engine	Hand operated speed control, additional foot operated speed control pedal with SJC option; key-type start switch or optional Keyless Start Panel or optional Deluxe Instrumentation Panel and function error shutdown
Service Brake	Two independent hydrostatic systems controlled by two hand operated steering levers or optional joystick(s)
Secondary Brake	One of the hydrostatic transmissions
Parking Brake	Mechanical disc activated by manually operated switch on left instrument panel



(S510) LOADER SPECIFICATIONS (CONT'D)

Hydraulic System

Pump Type	Engine driven, gear type
Pump Capacity	64,7 L/min (17.1 U.S. gpm)
System Relief at Quick Couplers	23,8 - 24,5 MPa (238 - 245 bar) (3450 - 3550 psi)
Filter (Hydraulic / Hydrostatic)	Replaceable beta 10 micron = 200, drop in element
Filter (Charge)	Replaceable beta 10 micron = 200, spin-on element
Hydraulic Cylinders: Bore Diameter: Lift Cylinder (2) Tilt Cylinder (2) Rod Diameter: Lift Cylinder (2) Tilt Cylinder (2) Stroke: Lift Cylinder (2) Tilt Cylinder (2)	Double-acting; lift cylinders have cushioning feature on lower, tilt cylinders have cushioning feature on dump and rollback 57,2 mm (2.25 in) 69,9 mm (2.75 in) 38,1 mm (1.50 in) 38,1 mm (1.50 in) 698,5 mm (27.50 in) 330,7 mm (13.02 in)
Control Valve - Standard	3-Spool, open centre, manually operated with spring detent for lift float; Electrically controlled auxiliary spool
Control Valve - ACS, AHC, and SJC	3-Spool, open centre with electric actuator controlled lift with float and tilt; Electrically controlled auxiliary spool
Fluid Lines	SAE Standard tubelines, hoses, and fittings
Hydraulic Function Time: - Raise Lift Arms - Lower Lift Arms - Bucket Dump - Bucket Rollback	3.3 seconds 2.8 seconds 2.3 seconds 1.7 seconds



(S510) LOADER SPECIFICATIONS (CONT'D)

Electrical System

Alternator	Belt driven, 90 amperes, open frame
Battery	12 volt, 700 cold cranking amperes @ -18°C (0°F), 110 minute reserve capacity @ 25 amperes
Starter	12 volt, gear type, 3,2 kW (4.29 hp)
Instrumentation	<p style="text-align: center;">Gauges: Engine Coolant Temperature and Fuel Level</p> <p style="text-align: center;">Warning lights: Fuel Level, Seat Belt, Engine Coolant Temperature, Engine Malfunction, Hydraulic System Malfunction, Diesel Particulate Filter (DPF) / Diesel Exhaust Fluid (DEF), and General Warning</p> <p style="text-align: center;">Indicators: BICS™ Functions, Two-Speed, 3-Point Restraint, and Turn Signals</p> <p style="text-align: center;">Data Display: Operating Hours, Engine rpm, Speed Management Setting, Maintenance Clock Countdown, Battery Voltage, Service Codes, Engine Preheat Countdown, Lift and Tilt Compensation Setting, Steering Drift Compensation Setting, and Drive Response Setting</p> <p style="text-align: center;">Other: Audible Alarm, Lights, and Option / Accessory Switches</p> <p style="text-align: center;">Optional Deluxe Instrumentation Panel: *Additional displays for: Engine rpm, Engine Coolant Temperature, Engine Oil Pressure, System Voltage, Hydraulic Fluid Temperature, and Hydrostatic Charge Pressure</p> <p>*Additional Features Included: Keyless Start, Digital Clock, Job Clock, Password Lockout, Multiple-Language Display, Help Screens, Diagnostic Capability, and Engine / Hydraulic Systems Shutdown Function</p>

Capacities

Fuel	93,7 L (24.75 U.S. gal)
Engine Oil with Filter Change	8,7 L (9.2 qt)
Engine Cooling System: - with Heater - without Heater	11,7 L (3.1 U.S. gal) 11,4 L (3.0 U.S. gal)
Hydraulic / Hydrostatic Reservoir	7,57 L (2.0 U.S. gal)
Hydraulic / Hydrostatic System	31,8 L (8.4 U.S. gal)
Chaincase Reservoir	32,2 L (8.5 U.S. gal)



(S510) LOADER SPECIFICATIONS (CONT'D)

Tyres

Standard Duty (Standard)	10.00 – 16.5, 8 Ply Rating
Heavy Duty (Option)	10.00 – 16.5, 10 Ply Rating
Heavy Duty Offset (Option)	10.00 – 16.5, 10 Ply Rating
Heavy Duty Offset Poly Fill (Option)	10.00 – 16.5, 10 Ply Rating
Heavy Duty Poly Fill (Option)	10.00 – 16.5, 10 Ply Rating
Severe Duty (Option)	10.00 – 16.5, 10 Ply Rating
Severe Duty Poly Fill (Option)	10.00 – 16.5, 10 Ply Rating
Solidflex (Option)	31 x 6 x 10
Super Float (Option)	31 x 12 – 16.5, 10 Ply Rating
Recommended Pressure	Inflate tyres to MAXIMUM pressure shown on the sidewall of the tyre; DO NOT mix brands of tyres used on the same loader

Environmental

DECLARED SINGLE-NUMBER NOISE EMISSION VALUES In accordance with ISO 4871	
Noise level per Directive 2000/14/EC — L_{wA}	101 dB
Operator noise level per Directive 2006/42/EC — L_{pA}	86 dB

DECLARED VIBRATION EMISSION VALUES In accordance with EN 12096		
	Value	Uncertainty
Whole-body vibration per ISO 2631-1	0,82 m/s ²	0,41 m/s ²
Hand-arm vibration per ISO 5349-1	1,44 m/s ²	- - -

Temperature Range

Operation and storage	-26 - +43°C (-15 - +110°F)
-----------------------	----------------------------



WARRANTY

WARRANTY207



WARRANTY

WARRANTY

BOBCAT LOADERS

Doosan Bobcat EMEA s.r.o. ("Doosan") warrants to its authorized dealers who in turn warrants to the customer that each new Bobcat Loader will be free from defects in material and workmanship for twelve (12) months from the date of delivery to the customer or 2000 hours of machine usage, whichever occurs first. During the warranty period, the authorized Doosan dealer shall repair or replace, at Doosan's option, without charge for parts, labour and travel of technicians, any part of the Doosan product which fails because of defects in material or workmanship. The customer shall provide the authorized Doosan dealer with prompt written notice of the defect and allow reasonable time for replacement or repair. Doosan may, at its option, request failed parts to be returned to the factory or to any other designated location. Transportation of the Doosan product to the authorized Doosan dealer for warranty work is not the responsibility of Doosan. Service schedules must adhere to prescribed intervals and Bobcat genuine parts/lubricants must be used. The warranty does not apply to tyres, tracks or other accessories not manufactured by Doosan. For coverage on engines, consult with your Bobcat Dealer. For these non-covered items, the customer shall refer solely to the warranty, if any, of the respective manufacturers thereof, in accordance with the respective manufacturers warranty statement. Some Doosan parts are covered pro-rata depending on the expected life-time of the part. Coverage for batteries, air-conditioning refill, couplers and ignition system parts (glow plugs, fuel injection pumps, injectors) is reduced as failures generally originate from factors not under Doosan's control such as, but not limited to, prolonged storage, abuse or fuel quality. Reduced coverage is, depending on the component, limited from 50 to 500 operating hours. The warranty does not cover: (i) Oils and lubricants, coolant fluids, filter elements, brake linings, tune-up parts, bulbs, fuses, alternator fan belts, drive belts, pins, bushings and other high-wear items. (ii) Damages resulting from abuse, accidents, alterations, use of the product with any bucket or attachment not approved by Doosan, air flow obstructions, or failure to maintain or use the Doosan product according to the instructions applicable to it. (iii) Ground engaging parts such as bucket teeth and cutting edges. (iv) Fuel or hydraulic system cleaning, engine tune-up, brake inspection or adjustment. (v) Adjustments or slight defects which generally do not affect the stability or reliability of the machine.

DOOSAN EXCLUDES OTHER CONDITIONS, WARRANTIES OR REPRESENTATIONS OF ALL KINDS, EXPRESSED OR IMPLIED, STATUTORY OR OTHERWISE (EXCEPT THAT OF TITLE) INCLUDING ALL IMPLIED WARRANTIES AND CONDITIONS RELATING TO MERCHANTABILITY, SATISFACTORY QUALITY AND FITNESS FOR A PARTICULAR PURPOSE. CORRECTIONS BY DOOSAN OF NONCONFORMITIES WHETHER PATENT OR LATENT, IN THE MANNER AND FOR THE TIME PERIOD PROVIDED ABOVE, SHALL CONSTITUTE FULFILLMENT OF ALL LIABILITIES OF DOOSAN FOR SUCH NONCONFORMITIES, WHETHER BASED ON CONTRACT, WARRANTY, TORT, NEGLIGENCE, INDEMNITY, STRICT LIABILITY OR OTHERWISE WITH RESPECT TO OR ARISING OUT OF SUCH PRODUCT. THE REMEDIES OF THE END-USER/OWNER SET FORTH UNDER THE PROVISIONS OF THE WARRANTY OUTLINED ABOVE ARE EXCLUSIVE AND THE TOTAL LIABILITY OF DOOSAN INCLUDING ANY HOLDING, SUBSIDIARY, ASSOCIATED OR AFFILIATED COMPANY OR DISTRIBUTOR WITH RESPECT TO THIS SALE OR THE PRODUCT AND SERVICE FURNISHED HEREUNDER IN CONNECTION WITH THE PERFORMANCE OR BREACH THEREOF, OR FROM DELIVERY, INSTALLATION, REPAIR OR TECHNICAL DIRECTION COVERED BY OR FURNISHED UNDER THIS SALE, WHETHER BASED ON CONTRACT, WARRANTY, TORT, NEGLIGENCE, INDEMNITY, STRICT LIABILITY OR OTHERWISE SHALL NOT EXCEED THE PURCHASE PRICE OF THE PRODUCT UPON WHICH SUCH LIABILITY IS BASED. DOOSAN INCLUDING ANY HOLDING, SUBSIDIARY, ASSOCIATED OR AFFILIATED COMPANY AND DISTRIBUTOR SHALL IN NO EVENT BE LIABLE TO THE END-USER/OWNER, ANY SUCCESSORS IN INTEREST OR ANY BENEFICIARY OR ASSIGNEE RELATING TO THIS SALE FOR ANY CONSEQUENTIAL, INCIDENTAL, INDIRECT, SPECIAL OR PUNITIVE DAMAGES ARISING OUT OF THIS SALE OR BY ANY BREACH THEREOF, OR ANY DEFECT IN, OR FAILURE OF, OR MALFUNCTION OF THE PRODUCT UNDER THIS SALE, WHETHER BASED UPON LOSS OF USE, LOST PROFITS OR REVENUE, INTEREST, LOST GOODWILL, WORK STOPPAGE, IMPAIRMENT OF OTHER GOODS, LOSS BY REASON OF SHUTDOWN OR NON-OPERATION, INCREASED EXPENSES OF OPERATION OR CLAIMS OF USER OR CUSTOMERS OF THE USER FOR SERVICE INTERRUPTION WHETHER OR NOT SUCH LOSS OR DAMAGE IS BASED ON CONTRACT, WARRANTY, TORT, NEGLIGENCE, INDEMNITY, STRICT LIABILITY OR OTHERWISE.





ALPHABETICAL INDEX

(S510) LOADER SPECIFICATIONS	200	LIFTING THE LOADER	115
ALTERNATOR BELT	172	LOADER IDENTIFICATION	8
ATTACHMENT CONTROL DEVICE (ACD)	89	LOADER STORAGE AND RETURN TO SERVICE	182
ATTACHMENTS	106	LUBRICATING THE LOADER	177
AUTOMATIC RIDE CONTROL ACCUMULATOR	176	MACHINE SIGNS (DECALS)	19
BACK-UP ALARM SYSTEM	132	MAINTENANCE CLOCK	198
BACK-UP ALARM SYSTEM	64	MAINTENANCE SAFETY	121
BOBCAT COMPANY IS ISO 9001 CERTIFIED	5	MONITORING THE DISPLAY PANELS	103
BOBCAT INTERLOCK CONTROL SYSTEM (BICS™)	125	OPERATING PROCEDURE	113
BOBCAT INTERLOCK CONTROL SYSTEM (BICS™)	57	OPERATOR CAB	134
BOB-TACH (HAND LEVER)	180	OPERATOR CAB	55
BOB-TACH (POWER)	181	OPERATOR SAFETY WARNINGS	1
CONTROL IDENTIFICATION	51	PARKING BRAKE	59
CONTROL PANEL SETUP	191	PASSWORD SETUP (DELUXE INSTRUMENTATION PANEL)	196
COUNTERWEIGHTS	105	PASSWORD SETUP (KEYLESS START PANEL)	195
DAILY INSPECTION	90	PIVOT PINS	179
DECLARATION OF CONFORMITY	3	PRE-STARTING PROCEDURE	92
DELIVERY REPORT	7	PUBLICATIONS AND TRAINING RESOURCES	18
DIAGNOSTIC SERVICE CODES	184	REAR DOOR (TAILGATE)	137
DRIVE BELT	173	REAR GRILLE	138
DRIVE RESPONSE	72	REGULAR MAINTENANCE ITEMS	5
DRIVING AND STEERING THE LOADER	65	SAFETY INSTRUCTIONS	14
ELECTRICAL SYSTEM	154	SEAT BAR RESTRAINT SYSTEM	126
EMERGENCY EXIT	61	SEAT BAR RESTRAINT SYSTEM	58
ENGINE AIR CLEANER	141	SEAT BELT	128
ENGINE COOLING SYSTEM	149	SERIAL NUMBER LOCATIONS	7
ENGINE LUBRICATION SYSTEM	147	SERVICE SCHEDULE	122
ENGINE SPEED CONTROL	60	SPARK ARRESTER MUFFLER	169
FEATURES, ACCESSORIES, AND ATTACHMENTS	9	SPEED MANAGEMENT	70
FINAL DRIVE TRANSMISSION (CHAINCASE)	171	STARTING THE ENGINE	96
FIRE PREVENTION	16	STEERING DRIFT COMPENSATION	74
FUEL SYSTEM	143	STOPPING THE ENGINE AND LEAVING THE LOADER	104
HEATING SYSTEM	139	STOPPING THE LOADER	68
HYDRAULIC / HYDROSTATIC SYSTEM	162	TOWING THE LOADER	115
HYDRAULIC CONTROLS	79	TRACTION LOCK OVERRIDE	59
INSTRUMENT PANEL IDENTIFICATION	37	TRANSPORTING THE LOADER ON A TRAILER	117
INTENDED USE	36	TWO-SPEED CONTROL	68
LIFT AND TILT COMPENSATION	76	TYRE MAINTENANCE	170
LIFT ARM BYPASS CONTROL	60	WARRANTY	207
LIFT ARM SUPPORT DEVICE	129		







